

# 20 MF WALL HUNG COMBINATION BOILER

Installation and servicing instructions

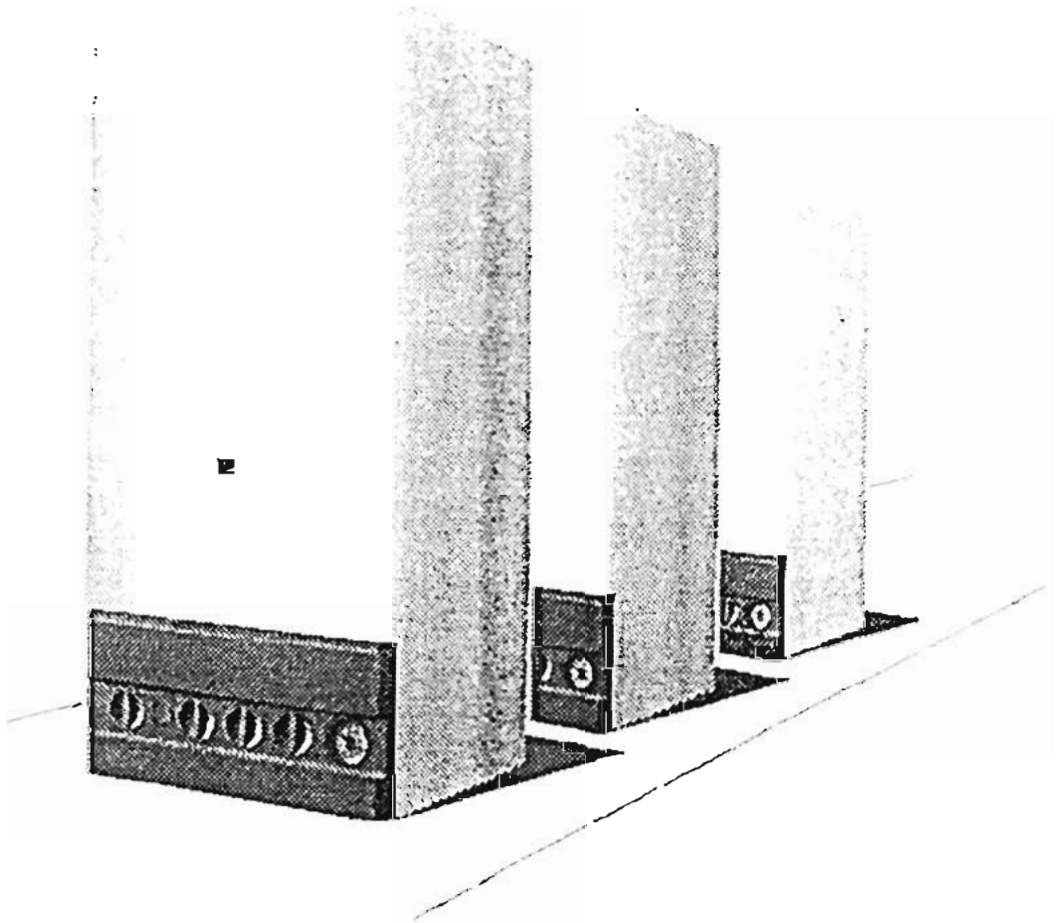

**ARISTON** 

Ariston Bathrooms Limited

Unit 1 Beech Road, High Wycombe, Bucks HP11 1RY  
Telephone: (0494) 459711

# TABLE OF CONTENTS

<b>1</b>	<b>General Information</b>	<b>1</b>
1.1	Overall view	1
1.2	Technical data	2
1.3	Description	3
1.4	Design principles and operating sequence	3
<b>2</b>	<b>General requirements</b>	<b>5</b>
2.1	Related documents	5
2.2	Location of appliance	5
2.3	Flue system	5
2.4	Gas supply	5
2.5	Air supply	6
2.6	Water circulation (central heating)	6
2.7	Domestic water	7
2.8	Electrical supply	7
<b>3</b>	<b>Installation</b>	<b>8</b>
3.1	Delivery	8
3.2	Measures for installing the appliance	8
3.3	Mounting the assembling template and cocks	8
3.4	Mounting the flue exhaust pipes	10
3.5	Unpacking the boiler	13
3.6	Mounting the boiler on the template	14
3.7	Electrical connections	14
<b>4</b>	<b>Commissioning</b>	<b>16</b>
4.1	Electrical installation	16
4.2	Gas supply installation	16
4.3	Checking the expansion vessel pressure	16
4.4	Filling the d.h.w. system	16
4.5	Initial filling of the system	17
4.6	Setting the system pressure	17
4.7	Lighting the boiler	18
4.8	Checking the gas pressure at the burner	18
4.9	Checking the flue system	19
4.10	Checking the operation of the flame failure device	19
4.11	Testing the d h w. system flow	20
4.12	Instructing the user	20
<b>5</b>	<b>Serviceing Instructions</b>	<b>21</b>
5.1	General	21
5.2	To gain general access	21
5.3	To drain the main circuit	22
5.4	To drain the d.h.w. circuit	23
5.5	To remove the regulation circuit board	23
5.6	To remove flue fan and venturi device	24
5.7	To remove the air switch	25
5.8	To remove the pilot burner	25
5.9	To remove the thermocouple	25
5.10	To remove injectors	25
5.11	To remove burner ramp unit	26
5.12	To remove gas modulator	26
5.13	To remove the modulating gas valve	26
5.14	To remove the safety thermostat	26
5.15	To remove main heat exchanger	27
5.16	To remove d.h.w. heat exchanger	27
5.17	Maintenance of d.h.w. heat exchanger	28
5.18	To remove NTC probe on d h.w. circuit	29
5.19	To remove NTC probe on main circuit	29
5.20	To remove circulator	29
5.21	Maintenance of d.h.w. flow switch	30
5.22	To remove main circuit flow switch	31
5.23	To remove temperature-pressure gauge	31

5 24	To remove by-pass	32
5 25	To remove automatic air release valve	32
5 26	To remove main circuit expansion vessel	32
5 27	To remove safety valve	33
5 28	To remove 3-way valve	33
5 29	To remove water unit	34
5 30	Setting gas pressures	36
5 31	Setting the max. rate for central heating system (Range rating)	36
5 32	Adjusting the pilot burner gas feed pressure	37
<b>6</b>	<b>Fault finding</b>	<b>39</b>
6 1	Fault finding diagrams	39
6 2	Using the fault finding diagrams	39
6 3	Special defects	39
6 4	Water leaks	39
6 5	Difficulty in lighting gas	39
6 6	Problems with modulation or combustion	39
6 7	Traces of gas or exhaust flues in the installation area	39
<b>7</b>	<b>Wiring diagrams</b>	<b>46</b>
7 1	General wiring layout	46
7 2	Electronic circuit board (power sect.)	46

Technical and illustrative data are not binding and can be modified without prior notice  
The descriptions and illustrations in the present booklet are for guideline purposes only.

# 1 GENERAL INFORMATION

## 1.1 Overall view

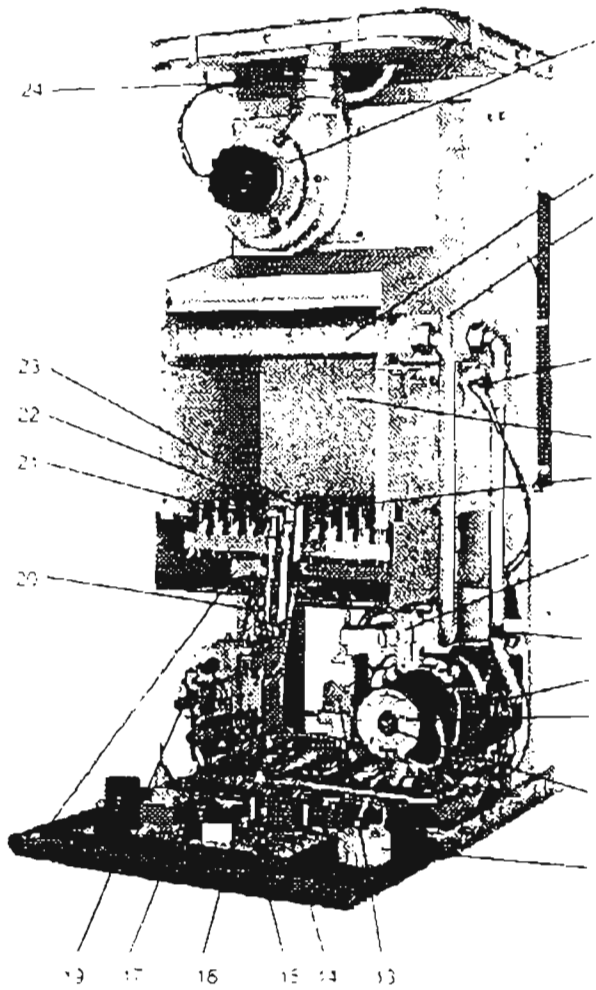

Front view

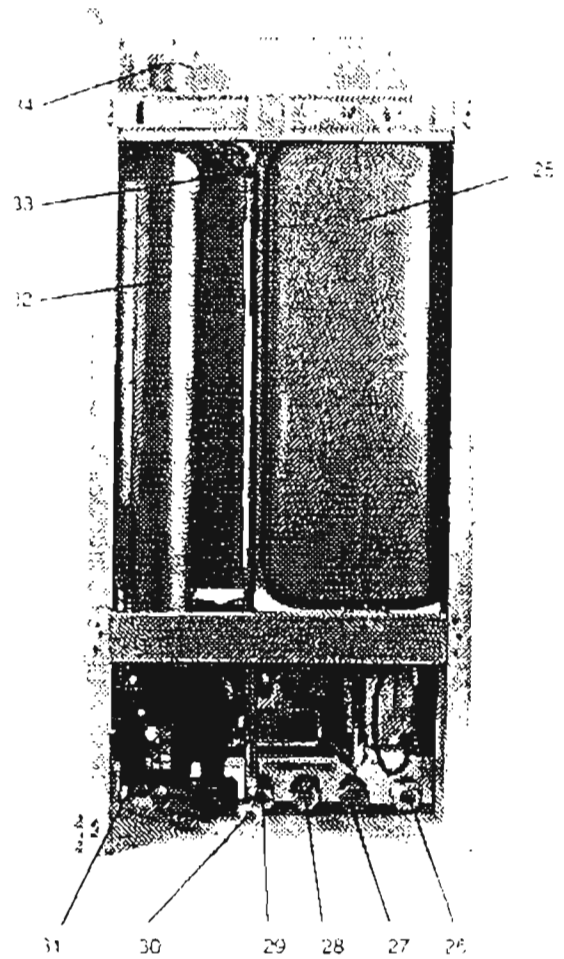

Rear view

- 1 Fan
- 2 Main heat exchanger
- 3 Manual vent cock
- 4 Safety thermostat
- 5 Combustion chamber
- 6 Burner
- 7 Main circuit flow switch
- 8 Thermometer probe
- 9 NTC probe on main circuit
- 10 Circulator
- 11 Circulator plug
- 12 Main circuit temperature pressure gauge
- 13 D h w flow switch
- 14 Plug for measuring inlet pressure at the gas valve
- 15 Electronic regulation circuit board
- 16 Safety valve
- 17 Modulating gas valve
- 18 Piezo-electric push button
- 19 Gas modulator
- 20 Plug for measuring outlet pressure at the gas valve
- 21 Thermocouple

- 22 Pilot burner
- 23 Lighter electrode
- 24 Venturi device
- 25 Expansion vessel
- 26 Gas inlet
- 27 heating hot water return
- 28 Heating hot water flow
- 29 d h w inlet
- 30 d h w outlet
- 31 3 way valve
- 32 D h w heat exchanger
- 33 NTC probe on d h w circuit
- 34 Automatic air release valve
- 35 Shutter on 3-way valve
- 36 Injector
- 37 D h w filter
- 38 D h w flow limiter (optional)
- 39 by pass
- 40 Main circuit drainage cock
- 41 Air switch
- 42 Flue outlet

## General information

### 1.2 Technical data

Heat input		
max	25.90 kW	88 388 Btu/h
min	9.70 kW	33 103 Btu/h

Heat output:		
max	23.26 kW	79 379 Btu/h
min	8.14 kW	27 779 Btu/h

#### Central heating

Operating temperature:		
max	85 °C	
min	35 °C	

Working pressure		
max	3 bar	43.5 p.s.i.

Built in expansion vessel:		
Total capacity	7.5 lts.	1.65 gals.
Pre-charge pressure	0.7 bar	10.1 p.s.i.

Available head at 1000 litres/hr (220 gals/hr)		
	3.2 m w.g.	126 ins w.g.

Max permissible cold water capacity without additional expansion vessel		
	150 lts.	33 gals.

#### D.h.w.

Operating temperature:		
max	65 °C	
min	37 °C	

flow rate:		
min	2.0 lts./min	0.4 gals./min
30 °C rise	11.1 lts./min	2.4 gals./min
35 °C rise	9.5 lts./min	2.0 gals./min
40 °C rise	8.3 lts./min	1.8 gals./min

Working pressure:		
max	10 bar	145 p.s.i.
min	0.2 bar	2.9 p.s.i.

#### Gas requirements

max gas rate	2.79 m <sup>3</sup> /h	98.5 ft <sup>3</sup> /h
min gas rate	1.04 m <sup>3</sup> /h	36.7 ft <sup>3</sup> /h

Inlet pressure	20 mbar	7.8 in w.g.
----------------	---------	-------------

Burner pressure		
max	9.7 mbar	3.8 in w.g.
min	1.4 mbar	0.5 in w.g.

Burner injectors	12 x 1.35	
------------------	-----------	--

#### Component details

Gas control valve	Honeywell	V 4600 N
Burner	Polidoro	

#### Electrical data

Electrical supply	240 V 50 Hz	
Power consumption	150 W	
External fuse rating	1.6 A	
Internal fuse rating	80 mA	

#### Connections

Gas connection	22 mm o.d.
Central heating flow	22 mm o.d.
Central heating return	22 mm o.d.
D.h.w. inlet	15 mm o.d.
D.h.w. outlet	15 mm o.d.
Safety discharge pipe	1/2"

#### Flue pipe specifications

flue pipe diameter	60 mm	2.36 ins
Standard length	850 mm	33.46 ins
Maximum length	4 000 mm	118.11 ins

#### Other specifications

Height	853 mm	33.6 ins
Width	400 mm	15.7 ins
Depth	370 mm	14.5 ins
Dry weight	43 kg	95 lb

## General information

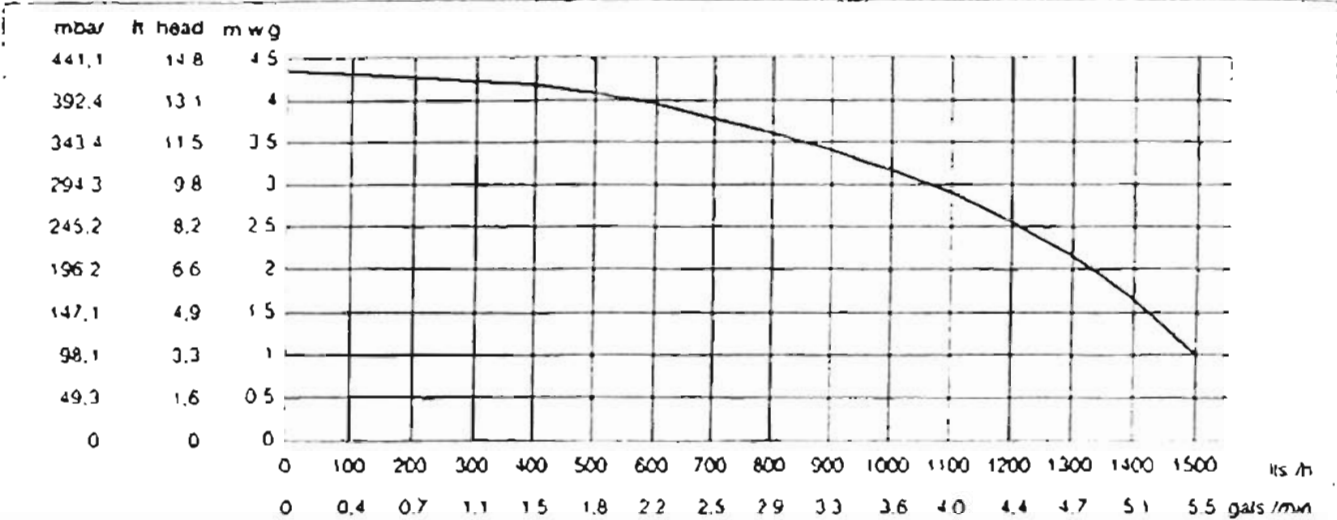

fig. 2.1

### Available pump head

The curve in fig. 2.1 shows the water pressure (head) available to the heating plant as a function of flow: the load loss of the appliance has already been subtracted.

### 1.3 Description

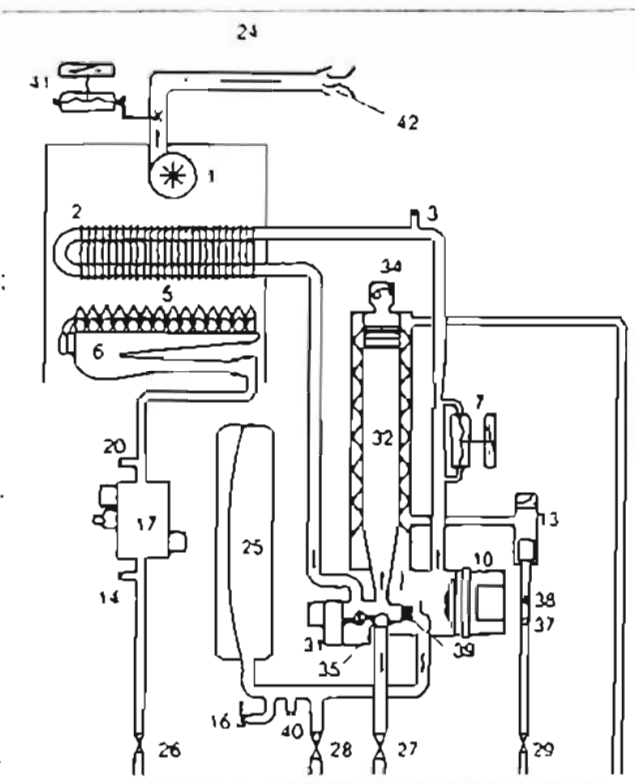

fig. 2.2

The ARISTON 20 MF is a combined central heating and d.h.w. (domestic hot water) appliance.

This appliance is suitable for wall mounting applications only.

It incorporates:

- fan powered flue outlet,
- circulating pump,
- pilot burner

ARISTON 20 MF

- expansion vessel,
- temperature and pressure gauge,
- safety valve,
- 3-way valve.

### 1.4 Design principles and operating sequence

#### Water system design

The basic purpose of a boiler is to generate heat through the combustion of gas and to direct the heat through a water circuit, as required.

A mixed function-type appliance allows the heat to be used both for heating the environment and for heating hot water for domestic use.

#### Main water circuit

This is an internal water circuit in the appliance which passes through the main heat exchanger and absorbs heat directly from the combustion of gas. The water in this circuit is the same as the water that is circulated by the circulator and flows through the central heating system.

The path of the water in the main water circuit can be changed by a 3-way deviation valve. The main water circuit is connected to the heating water circuit during operation with the central heating system (see fig. 2.3).

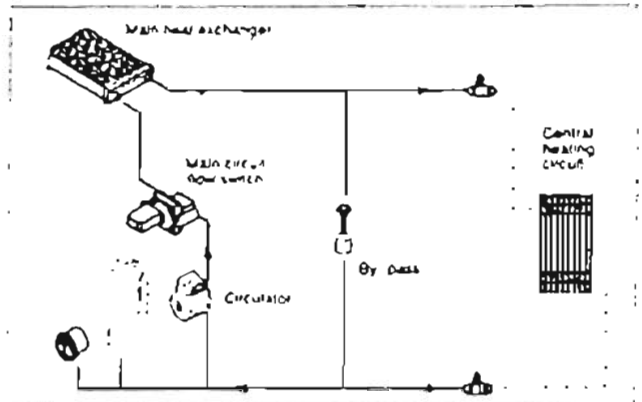

fig. 2.3

During operation as a d.h.w. heater, the main water circuit is directed through the d.h.w. heat exchanger (see fig. 2.4).

## General information

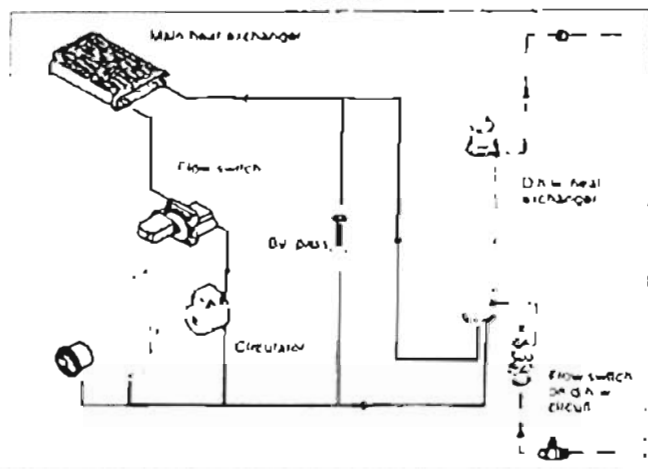

fig. 2.4

Also, a by-pass valve is installed in the main water circuit. The by-pass valve assures an adequate water flow through the main heat exchanger regardless of water flow conditions in the water circuit, thus avoiding damage due to temperature variations.

### Safety devices

In both central heating and d.h.w. modes safe operating is ensured by a flow switch on heating hot water circuit which disconnect the gas control valve supply shutting down the burner.

ARISTON 20 MF boilers are equipped with a safety thermostat which operates by opening an electrical contact if the primary water circuit overheats.

The thermal safety circuit is separate from all other electrical circuits and acts directly on a gas safety valve incorporated in the gas control valve.

A safety valve is provided to relieve excess pressure from the main circuit.

The appliance is equipped with a safety system (venturi device and air switch) which controls the velocity of the exhaust flues. The pressure differential switch could interfere with the lighting of the burner if allowed to collect in the combustion chamber.

### Operating sequence on heating mode

The selector switch must be set on  position.

Heating water is sent to the radiator system when the 3-way valve is in the heating position. In this configuration, the shutter is in the upper position and the heater exchanger for d.h.w. circuit is cut out.

The appliance is controlled by an electronic thermostat; water delivery temperature can be adjusted from 35 °C to 85 °C.

At the same time, the temperature of the heating circuit is measured by the NTC probe and this temperature is compared with the value set on the heating temperature selector ().

After lighting has been accomplished, the amount of flow from the gas valve is determined by the electronic regulator:

- when the temperature of the heating water is less than the preset temperature by a  $\Delta T$  value (difference between output and input temperature) between 6 °C and 15 °C, the appliance will supply heating power which ranges from 35 to 100% of its maximum capacity;
- when the temperature of the heating water is less than the preset temperature by a  $\Delta T$  value which is less than 6 °C, the appliance will supply its minimum heating power (35% of its maximum heating power);
- if the minimum power is greater than the heat emitted from the radiators, the burner will shut down.



Heating power can be varied from 35 to 100% of the maximum rated power

If a strong wind is present, the burner may shut down momentarily; this occurs because the normal exhaust of flues by the fan (which continues to operate normally) is impeded and the air switch shuts off the gas valve

### Operating sequence on d.h.w. mode

Whenever a d.h.w. tap is opened, the flow switch on the d.h.w. system is activated and a signal is sent to the d.h.w. regulation circuit. This circuit closes the shutter on the 3-way valve and thus closes the heating water circuit. The burner will operate at nominal power, or at a power rating which keeps d.h.w. at the constant temperature desired (as long as the demand for heating power does not exceed the nominal power supplied by the boiler). Thus, burner operation depends on the amount of d.h.w. used and the temperature which has been set on the d.h.w. temperature selector (.

### D.h.w. only operation

When the selector is set on  position, the heating hot water adjustment system is deactivated, the 3-way valve is no longer actuated, the shutter closes water delivery to the heating circuit and opens delivery to the d.h.w. heat exchanger. When d.h.w. is withdrawn from the d.h.w. system, operation of the appliance will be the same as operation with the selector switch set on  position.

## 2 GENERAL REQUIREMENTS

This appliance must be installed by a competent person in accordance with the Gas Safety (Installation & Use) Regulations 1984.

### 2.1 Related documents

The installation of this appliance must be in accordance with the relevant requirements of the Gas Safety (Installation & Use) Regulations (1984), the Local Building Regulations, the current I.E.E. Wiring Regulations, the by-laws of the local water undertaking, and in Scotland, in accordance with the Building Standards (Scotland) Regulation.

It should be in accordance also with the following British Standard Codes of Practice:

Low pressure installation pipes	BS 6891	1988
Boilers of rated input not exceeding 60 kW	BS 6798	1987
Forced circulation hot water systems	BS 5449-1	1977
Installation of gas hot water supplies for domestic purposes (2 <sup>nd</sup> family gases)	BS 5546	1979
Flues	BS 5540-1	1978
Air supply	BS 5540-2	1976

### 2.2 Location of appliance

The appliance may be installed in any room or internal space, although particular attention is drawn to the requirements of the current I.E.E. Wiring Regulations, and in Scotland, the electrical provisions of the Building Regulations applicable in Scotland, with respect to the installation of the combined appliance in a room containing a bath or shower.

In a room containing a bath or shower, any electrical switch should not be touched by a person using the bath or shower.

The location must permit an adequate space for servicing and air circulation around the appliance (see fig. 3.1).

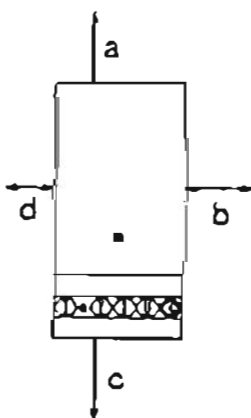

a	400 mm	15.7 ins
b	130 mm	5.1 ins
c	600 mm	26.6 ins
d	50 mm	1.9 ins

fig. 3.1

The location must permit the provision of an adequate flue and termination.

For unusual locations special procedures may be necessary and BS 6798-1987 gives detailed guidance on this aspect.

A compartment used to enclose the appliance must be designed specifically for this purpose

This appliance is not suitable for external installation

### 2.3 Flue system

The provision for satisfactory flue termination must be made as described in BS 5440-1

The appliance must be installed so that the flue terminal is exposed to external air

It must not be installed so that the terminal discharges into an other room or space as an outhouse or lean-to. It is important that the position of the terminal allows a free passage of air across at all times.

The terminal should be located with due regard for the damage or discoloration that might occur to building products in the vicinity

In cold and/or humid weather water vapour may condense on leaving the flue terminal; the effect of such "steaming" must be considered.

The minimum acceptable spacing from the terminal to obstructions and ventilation openings are specified in fig. 3.2.

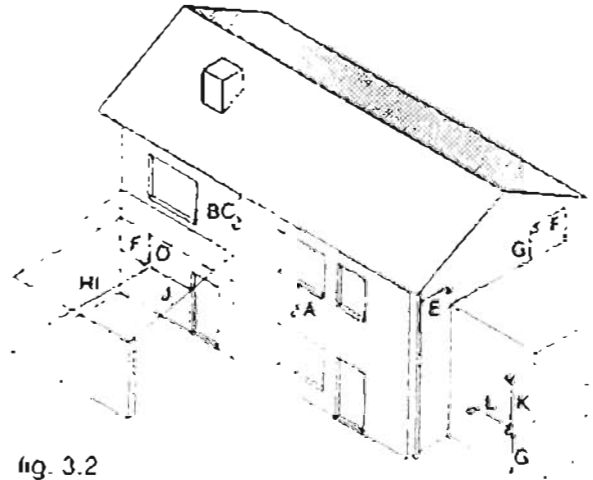

fig. 3.2

Terminal position	mm	
A	Directly below a open window or other opening	300
B	Below gutters, solid pipes or drain pipes	75
C	Below eaves	200
D	Below balconies or car port roof	200
E	From vertical drain pipes and soil pipes	75
F	From internal or external corners	300
G	Above ground or below balcony level	300
H	From a surface facing a terminal	600
I	From a terminal facing a terminal	1 200
J	From an opening in the car port (a g door, window) into dwelling	1 200
K	Vertically from a terminal in the same wall	1 500
L	Horizontally from a terminal in the same wall	300

### 2.4 Gas supply

Gas meter is connected to the service pipe by the local gas region or a local gas region contractor.

If the gas supply for the boiler serves other appliances ensure that an adequate supply is available both to the



## General requirements

boiler and the other appliance when they are in use at the same time.

Pipework must be of adequate size. Pipes of a smaller size than the boiler inlet connection should not be used. Installation pipes should be lined in accordance with BS 6891-1988 and the complete installation should be tested for soundness.

### 2.5 Air supply

The room in which the boiler is installed requires a purpose provided air vent.

If installed in a cupboard or compartment, ventilation is also required for cooling.

Recommendations for air supply are detailed in BS 5440-2.

### 2.6 Water circulation (central heating)

Detailed recommendations are given in BS 6798-1987 and BS 5449-1 1977; the following notes are given for general guidance.

#### Pipework

Copper tubing to BS 2871-1 1977 is recommended for water pipes. Jointing should be either with capillary soldered or with compression fittings.

Where possible pipes should have a gradient to ensure air is carried naturally to air release points and water flows naturally to drain taps.

The appliance has a built-in automatic air release valve anyway, it should be ensured as far as possible that the appliance heat exchanger is not a natural collecting point for air.

Except where providing useful heat, pipes should be insulated to prevent heat loss and to avoid freezing.

Particular attention should be paid to pipes passing through ventilated spaces in roofs and under floors.

#### By-pass

The appliance includes an automatic by-pass valve which protects the main heat exchanger in case of reduced or interrupted water circulation through the heating system due to the closing of thermostatic valves or cock-type valves within the system.

The by-pass is calibrated to assure a minimum flow of 500-600 l/s/hr through the primary heat exchanger.

#### System design

A typical lay-out is illustrated in the following figure.

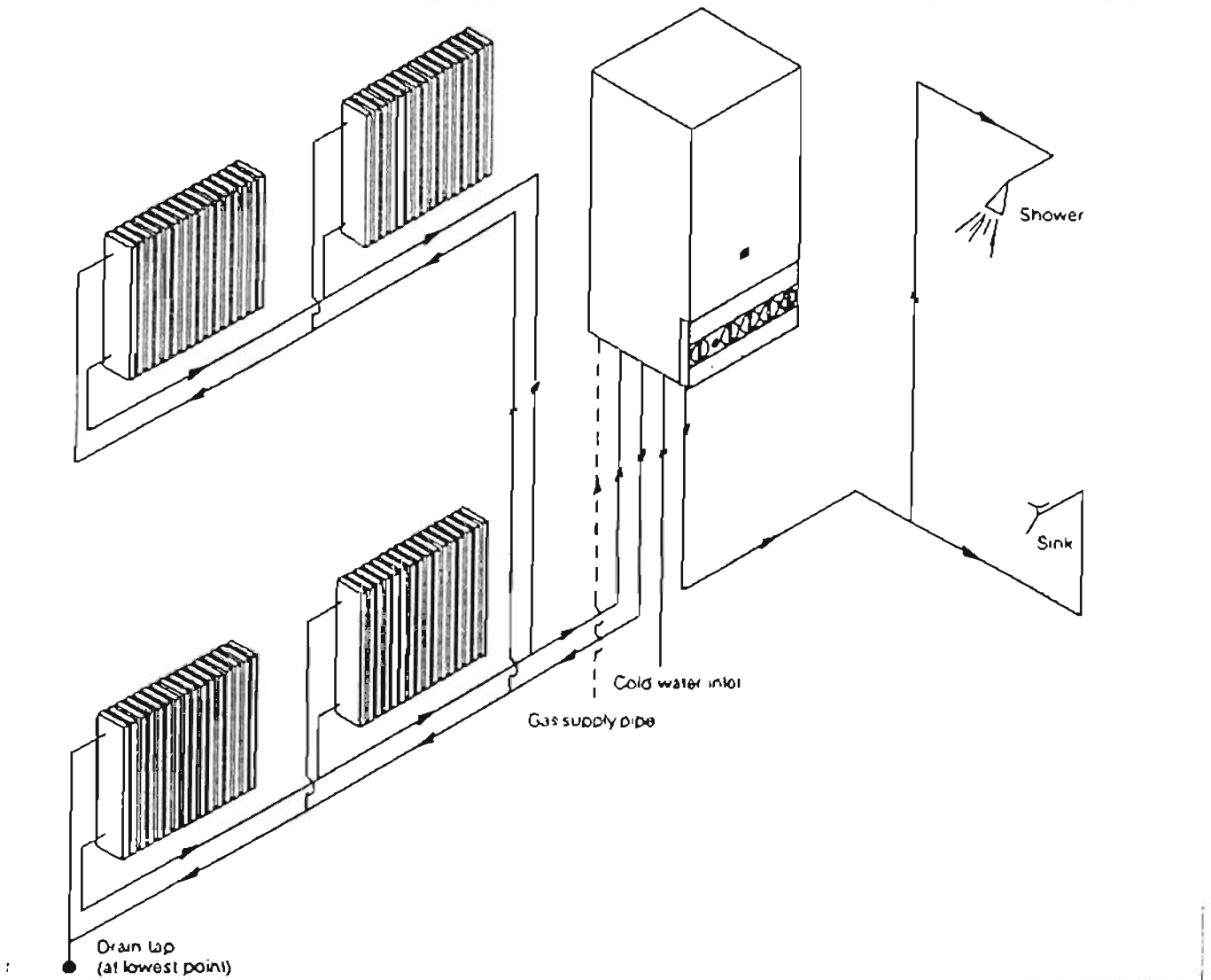

fig. 3.3

## General requirements

### Draining taps

These must be located in accessible positions to permit the draining of the whole systems. The taps must be at least 15 mm nominal size and manufactured in accordance with BS 2870 1980.

### Air release points

These must be fitted at all high points where air will naturally collect and must be sited to facilitate complete fitting of the system.

The appliance has an integral sealed expansion vessel to accommodate the increase of water volume when the system is heated.

It can accept up to 7 lts (1,5 gals.) of expansion water.

If the heating circuit has an unusually high water content, calculate the total expansion and add additional sealed expansion vessel with adequate capacity.

### Mains water feed: central heating

There must be no direct connection to the mains water supply even through a non return valve, without the approval of the Local Water Authority.

### Filling

A method for initially filling the system and replacing water lost during servicing must be provided and it must comply with local water authority regulations.

A possible method is shown in fig. 3.4.

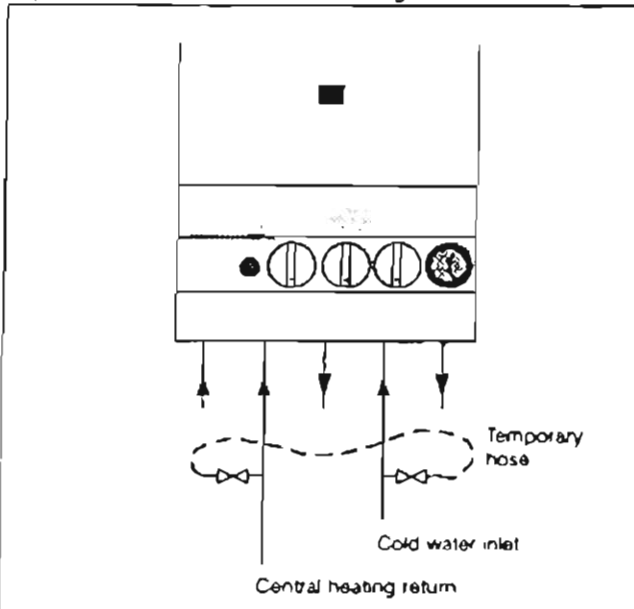

fig. 3.4

The installer should ensure that no leaks exist as frequent filling of the system could cause premature scaling of the heat exchanger.

## 2.7 Domestic water

The domestic water must be in accordance with the relevant recommendations of BS 5546. Copper tubing to BS 2871-1 is recommended for water carrying pipework and must be used for pipework carrying potable water.

## 2.8 Electrical supply

**Warning, this appliance must be earthed.**

External wiring to the appliance must be carried out by a competent person and be in accordance with the current I.E.E. Regulations and local regulations which apply.

The ARISTON 20 MF is supplied for connection to a 240 V ~ 50 Hz supply. The supply must be fused at 3A.

The method of connection to the electricity supply must facilitate complete electrical isolation of the appliance by the use of a fused double pole isolator having a contact separation of at least 3 mm in all poles.

The point of connection to the electricity supply must be readily accessible and adjacent to the appliance except where the appliance is installed in a bathroom this must be sited outside the bathroom.

### 3 INSTALLATION

#### 3.1 Delivery

- ARISTON 20 MF boiler will be delivered as follows:
  - the boiler fully assembled,
  - the assembling template with cocks and pipes;
  - flue exhaust pipes

#### 3.2 Measures for installing the appliance

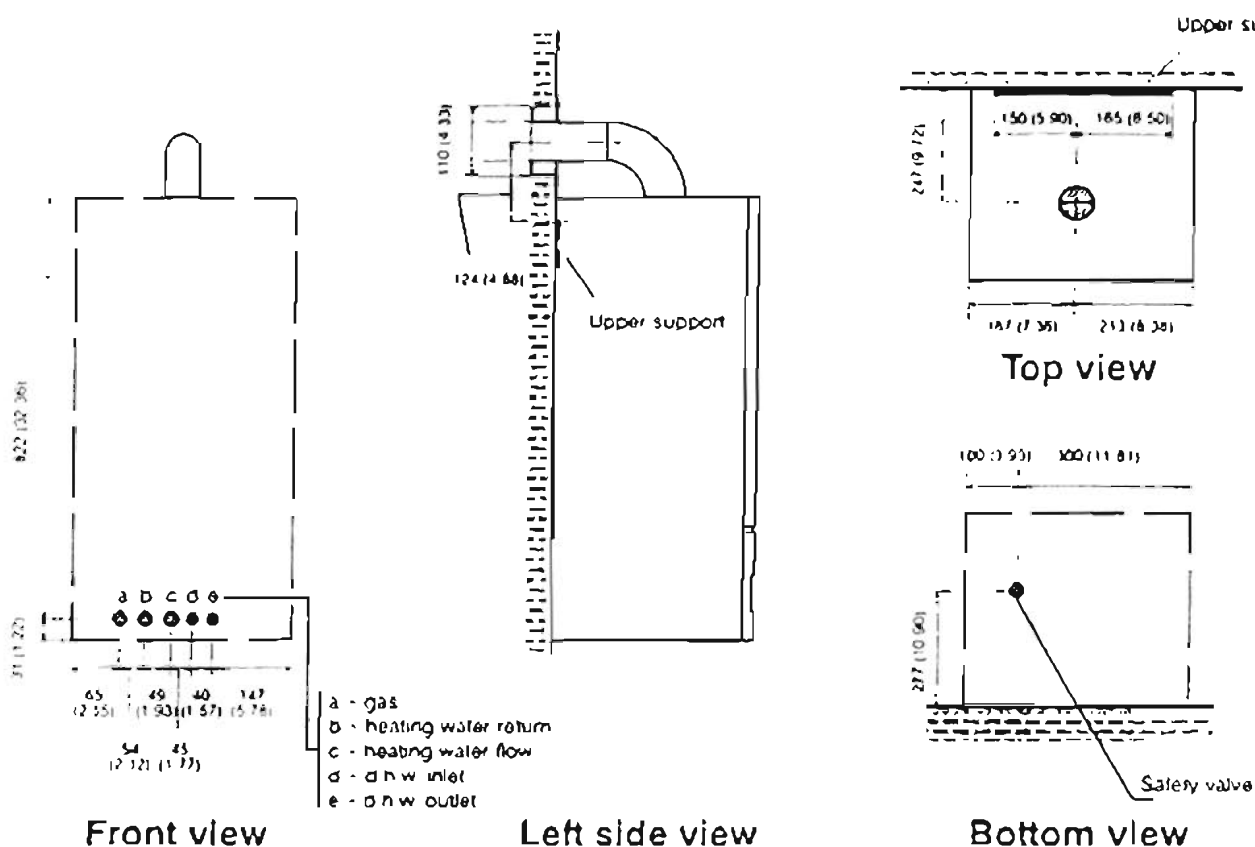

All measures are in millimetres (inches in brackets)

#### 3.3 Mounting the assembling template and cocks

Refer to the measures indicated for screw-up the assembling template.

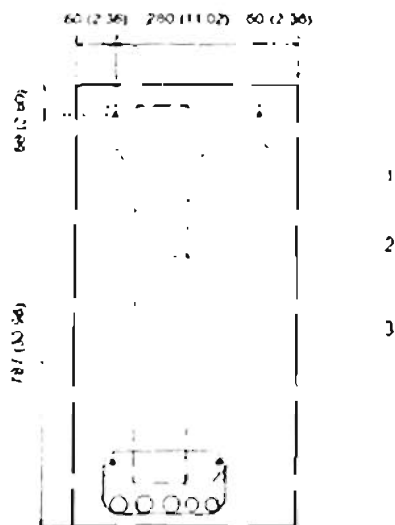

All measures are in millimetres (inches in brackets)

## Installation

### Rear outlet

$$L_e = L_x + 204 (8.03)$$

$$L_{e \text{ max}} = 770 (30.31)$$

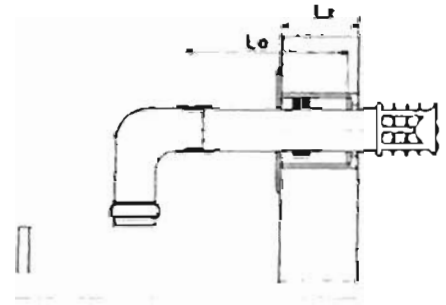

### Right side outlet

$$L1 \text{ min} = 172 (6.77)$$

$$L1 \text{ max} = 648 (25.51) - L_x$$

$$L_e = L_x + L1 + 122 (4.80)$$

$$L_{e \text{ max}} = 770 (30.31)$$

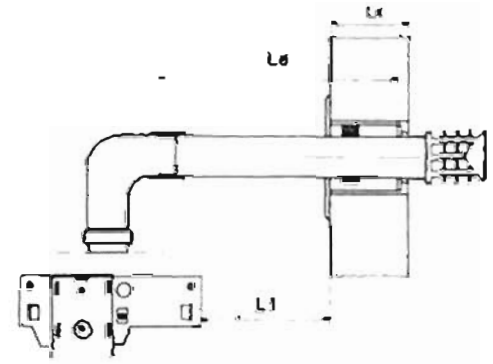

### Left side outlet

$$L2 \text{ min} = 92 (3.62)$$

$$L2 \text{ max} = 663 (26.10) - L_x$$

$$L_e = L_x + L2 + 107 (4.21)$$

$$L_{e \text{ max}} = 770 (30.31)$$

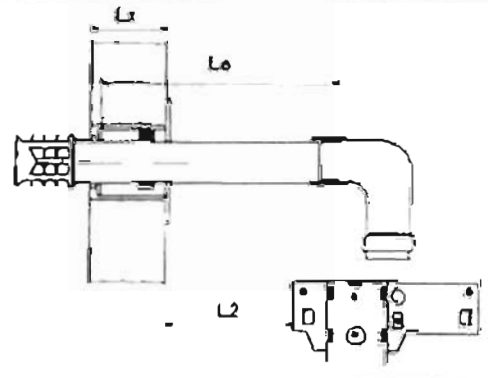

## Mounting operations

Drill a hole with a diameter of at least 110 mm (4.33 ins) in the wall; for correct position see sect.3.2.

Drill the hole in the direction of the flue exhaust pipe.

When drilling, apply a downward inclination of 3%.

Cut the pipe to pass through the wall the same length as the thickness of the wall so that is possible to use the rimmed part.

Insert this pipe in the hole in the wall making sure that the rimmed part is on the outside.

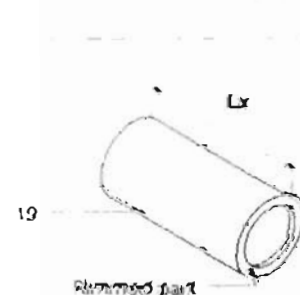
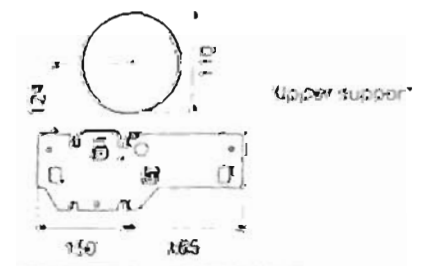

## installation

- Put the triangular support on the flue exhaust pipe and slide into the pipe in the wall making sure that the wind-resistant flue vent ring rest on the rim
- Put the flange on the flue exhaust pipe and mark the wall with the exact position of the holes for its fastening.
- Remove the flange and the flue exhaust pipe and make three holes in the wall to fit the 5 mm wall plugs
- Re-assemble the flue exhaust pipe complete with the triangular support in the pipe in the wall.
- Place the gasket over the flue exhaust pipe
- Fix the elbow well so that it is perfectly engaged with the flue exhaust pipe; then, fix the elbow to the appliance support end block with the screw.
- Seal the joint between the elbow and flue exhaust pipe using the gasket previously assembled, and fix the flange to the wall.

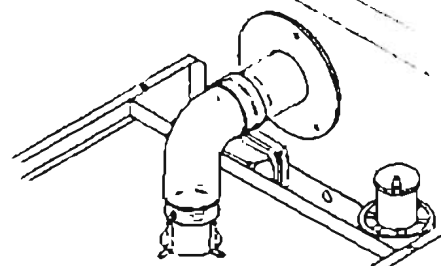
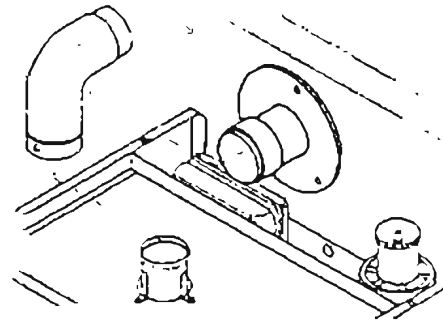
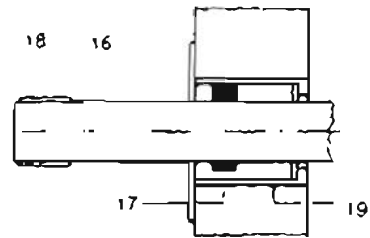
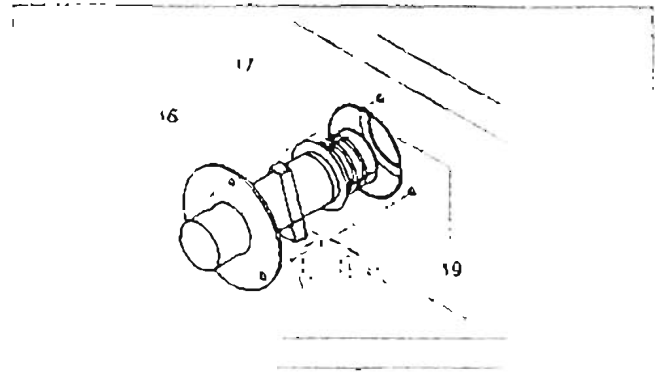

### 3.5 Unpacking the boiler

- Open the side of the carton marked *opening side*:

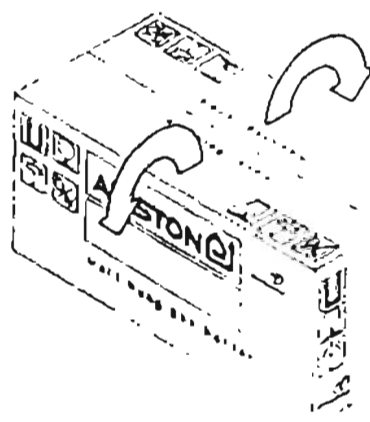

- overturn the carton keeping the flaps open:

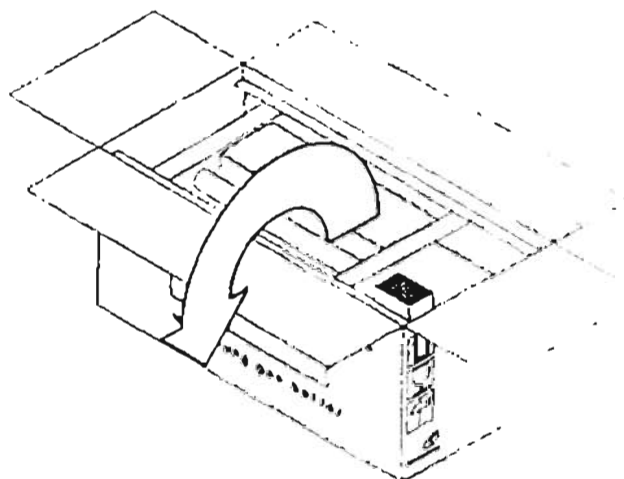

- lift up the carton:

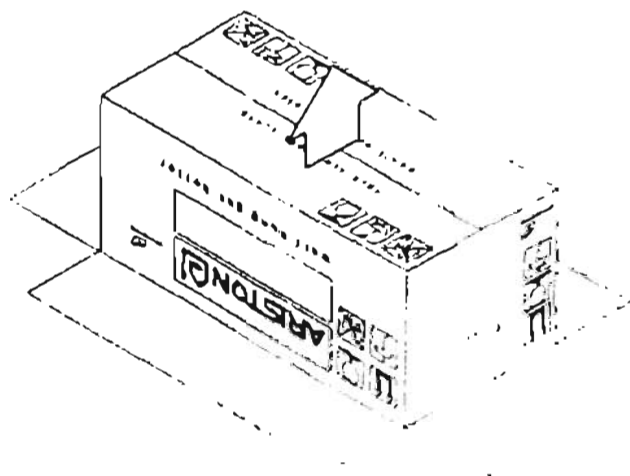

- rest the boiler on the floor and remove the polystyrene guards.

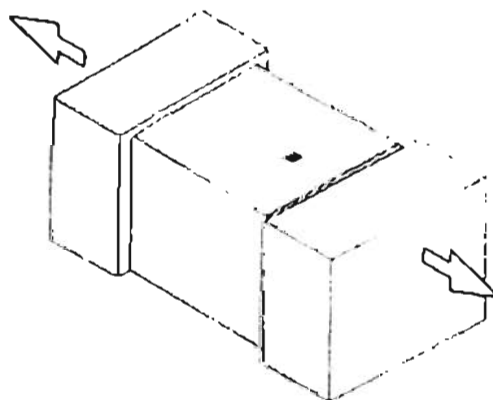

### 3.6 Mounting the boiler on the template

- Remove the nut indicated and its washer from the upper support for the template.  
remove the protection caps from the pipes on the boiler;  
carefully clean the cocks mounted on the connection plate;  
mount the appliance on its support
- remove the lower protection grille (sect. 5.2).
- install connectors on the pipes (use the original gaskets supplied with the template).  
tighten the connectors securely.
- re-install the grille;
- re-install the washer and nut on the upper support.

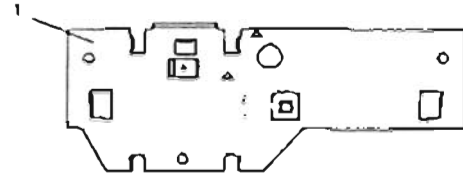

### 3.7 Electrical connections

#### Connecting to the electricity supply

#### WARNING - THIS APPLIANCE MUST BE EARTHED

The appliance is delivered with a flexible cable for electrical supply.

The cable allows the electric connection to the main isolating switch as shown in figure

As the colour of the wires in the mains lead of this appliance may not correspond with the coloured markings identifying the terminals in your plug, proceed as follows:

- the wire which is coloured green and yellow must be connected to the terminal in the plug which is marked with the letter E or by the earth symbol  or coloured green or green and yellow.
- the wire which is coloured blue must be connected to the terminal which is marked with the letter N or coloured black.
- the wire which is coloured brown must be connected to the terminal which is marked with the letter L or coloured red

To gain access to the electric supply cable open the control panel (sect. 5.2).

Make sure all wires to the appliance are routed away from sharp edges and hot surfaces

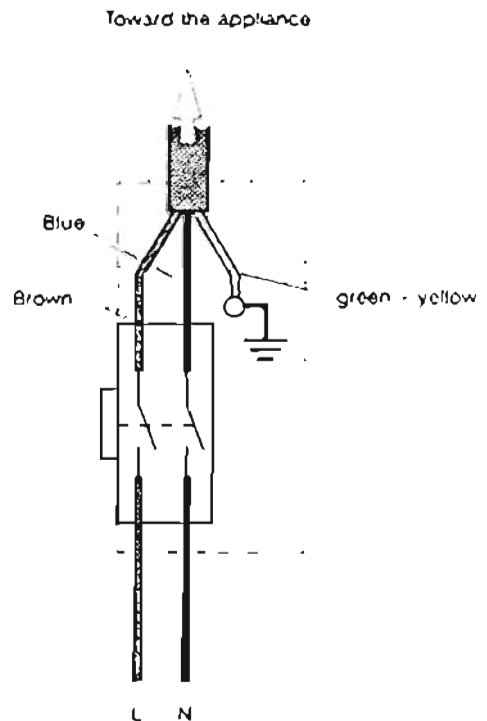

#### Connecting the external controls (room thermostat, timeclock)

- Open the control panel (sect. 5.2);
- open the service access door by sliding it in the direction shown by the arrow;
- remove the electric link between terminals TT and TC on the terminal board

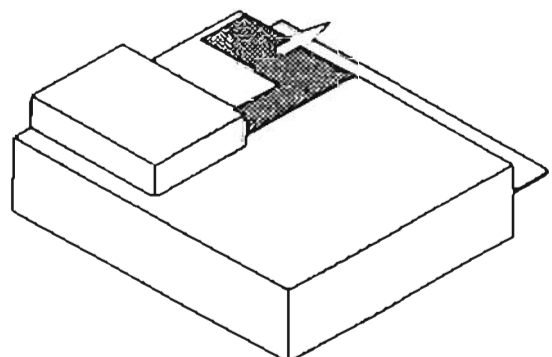

## Installation

**WARNING - EXTERNAL CONTROLS LINES MUST BE INSULATED FROM ELECTRIC SUPPLY LINES.**

Connecting a "simple contact" room thermostat.

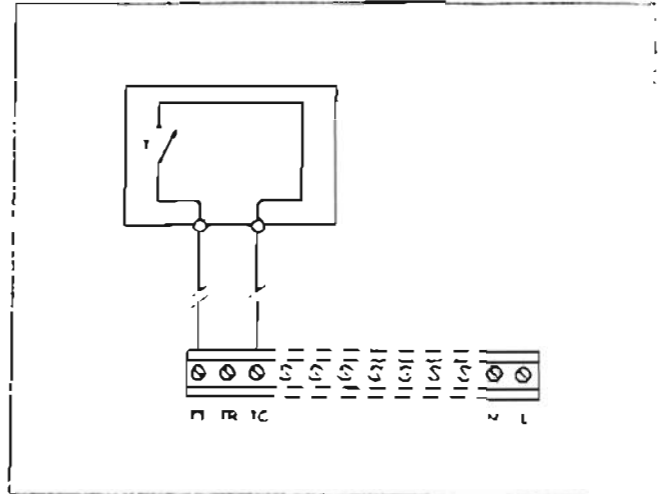

Connecting a room thermostat with delay resistor.

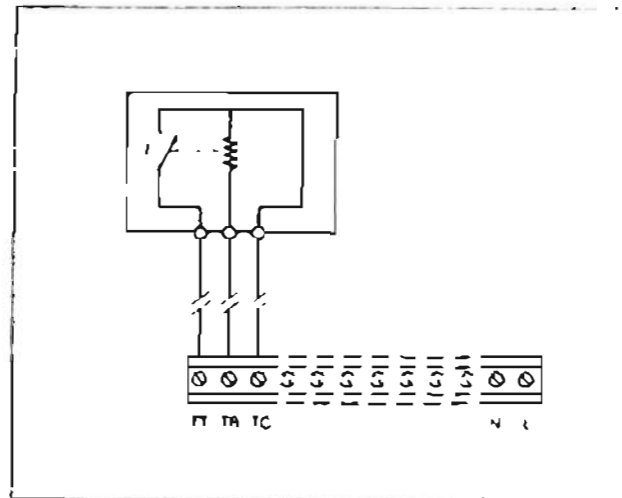

Connecting a timeclock.

Do not insert any internal links on time clocks, doing so may invalidate guarantee.

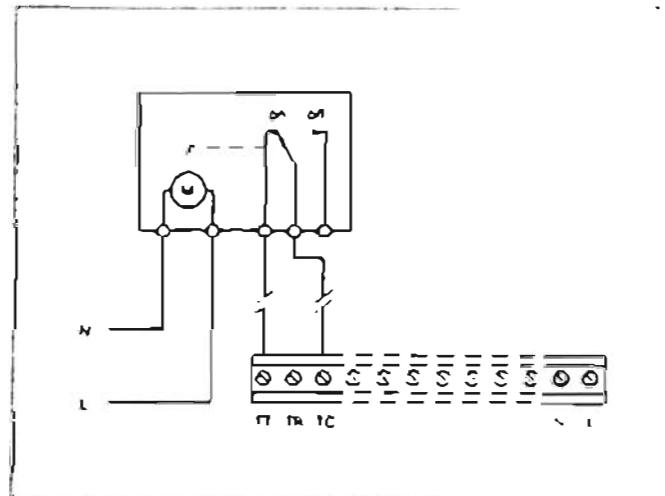



## 4 COMMISSIONING

### 4.1 Electrical installation

Preliminary electrical system checks to ensure electrical safety shall be carried out by a competent person.

If a fault has occurred on appliance the fault finding procedure should be followed as specified under the servicing section of this document.

### 4.2 Gas supply installation

1. Inspect the entire installation including the gas meter, test for soundness and purge, all as described in BS 6891.
2. Open the gas cock on the appliance and check the gas connector on the appliance for leaks.

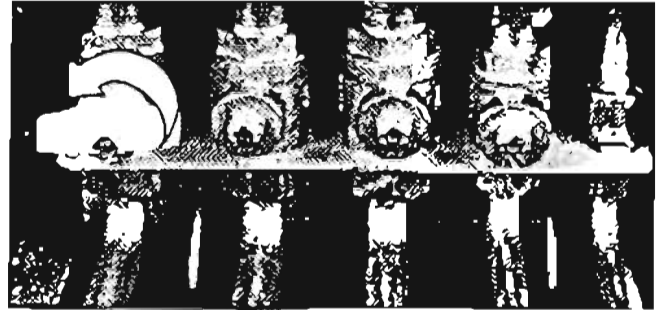

### 4.3 Checking the expansion vessel pressure

1. Open the control panel (sect. 5.2).
2. Check the expansion vessel pressure.

The expansion vessel is normally pressurized to 0.7 bar (10.1 p.s.i.)

Pressurization and pressure measurements are carried out through valve located at the bottom of the vessel.

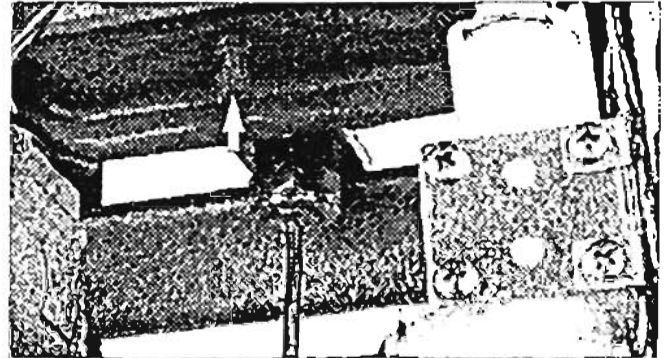

### 4.4 Filling the d.h.w. system

1. Close all hot water draw-off taps.
2. Open the cold water inlet cock.
3. Slowly open each draw-off tap and close it only when clear water, free of bubbles, flows out.

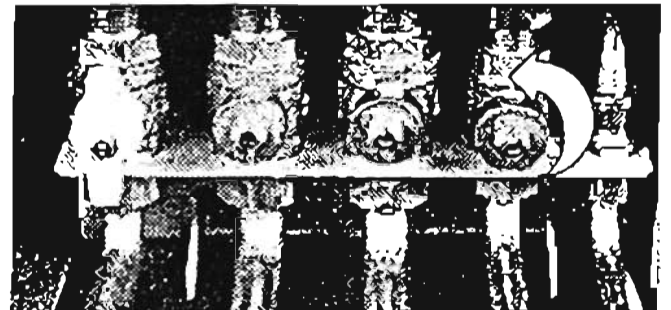

### 4.5 Initial filling of the system

1. Open the air vent on the wall (see Fig. 10) and bleed the air from the radiator. If the radiator is not filled, the air vent will not work. The radiator must be filled to the top.
2. Put the boiler in "bock" at the filling point. The boiler will fill the heating system. The water must be filled to the top fully.
3. Open each air release tap starting with the lowest point and close it only when clear water flow is bubbling through.
4. Make sure that the control panel shows a correct system pressure (see Fig. 11) and that the light is on.
5. Open the boiler relief (see Fig. 12).
6. Plug the drain of the pump by attaching the pump to the drain of the pump by turning the water in the pump. The water will be released into the drain only.
7. Close the drain.
8. Start the boiler with the water level at 14.5. The boiler will start pumping water at 11.5.
9. Inspect the system for water soundings. If there is any leakage, it is fixed.

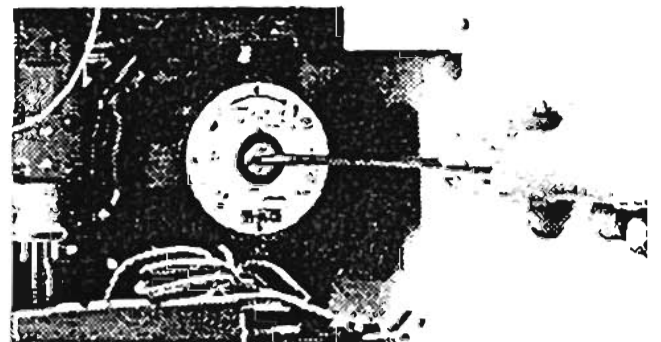
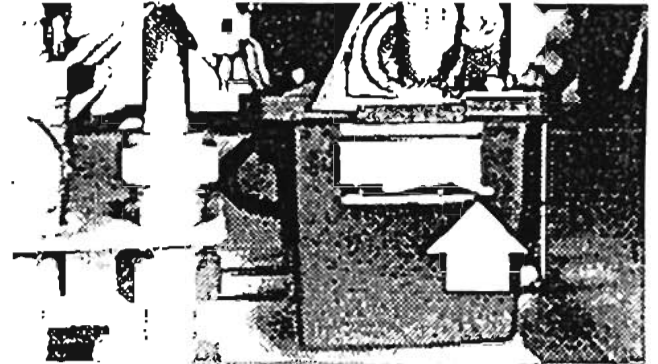
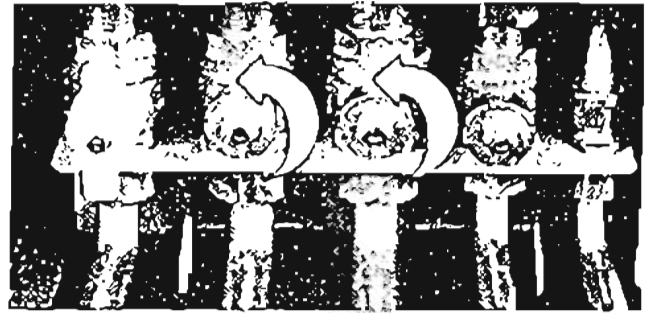

### 4.6 Setting the system pressure

1. The boiler must be fully loaded before the pressure is set. The pressure is set to the highest point of the system (see Fig. 13).

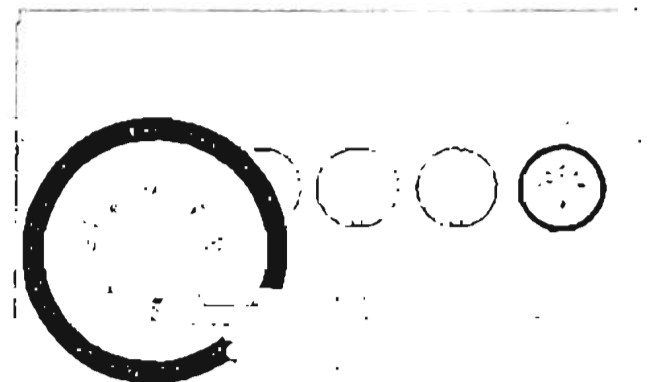

### 4.7 Lighting the boiler

If external controls are fitted (e. g. Timeclock, room thermostat) ensure they "call for heat".

Commissioning operations will be easier if controls are disconnected and terminals TT and TC are linked as shown

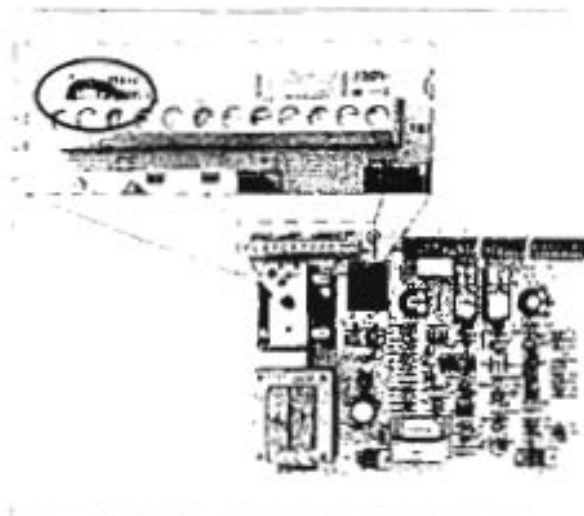

- 1 Press the gas control knob down well;
- 2 Press the piezo-electric button several times until the pilot burner lights up.  
The lighting of the pilot burner may be problematic if there is air in gas pipes (recent installation or maintenance)
- 3 Keep the button pressed for about 20 seconds and then release gently.
- 4 Switch on the mains electricity and turn the selector switch as indicated, the burner will light.

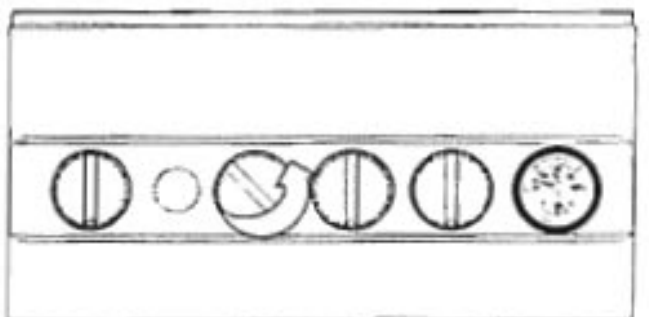
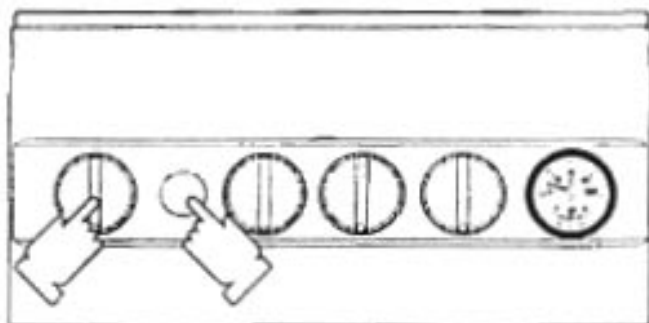

### 4.8 Checking the gas pressure at the burner

Checking maximum and minimum pressure levels

- 1 Open the control panel and remove the front panel (sect. 5.2).
- 2 unscrew the outlet pressure tap on the gas valve (one turn in anti-clockwise direction) and fit a pressure gauge using a hose;
- 3 withdraw a quantity of domestic hot water with a strong jet.

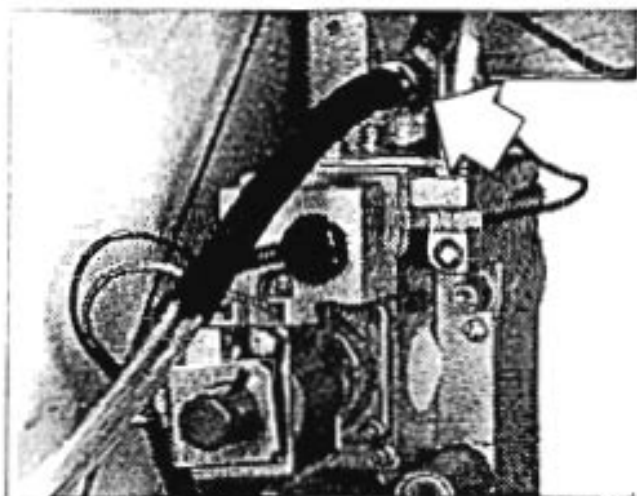

## Commissioning

- 4 turn the selector switch as indicated.
- 5 set the d n w. adjustment and the central heating adjustment to theirs maximum position.
- 6 check the maximum gas pressure and compare the value on the manometer with the values on sect. 1.2 (technical data) at page 2.  
If the pressure is wrong it should be adjusted as instructed in sect. 5.30 at page 36.
- 7 check the maximum gas flow at the gas meter and compare with the values on sect. 1.2 (technical data) at page 2.
- 8 switch off the appliance turning the selector switch in "0" position.
- 9 disconnect one of the power lines (low voltage) from the gas modulator;
- 10 turn the selector switch in d n w. -heating position;
- 11 check the minimum gas pressure and compare the value on the manometer with the values on sect. 1.2 (technical data) at page 2.  
If the pressure is wrong it should be adjusted as instructed in section 5.30 at page 36.
- 12 switch off the appliance and re-connect the line to the gas modulator;

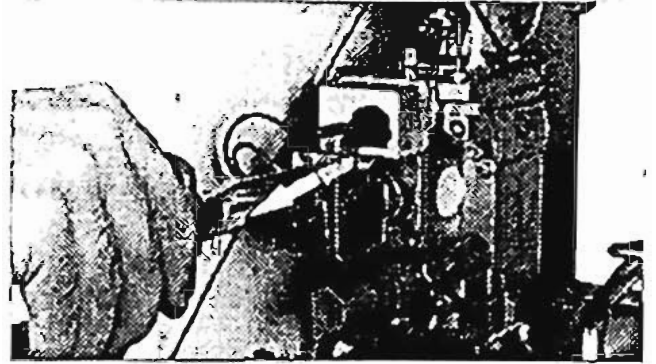
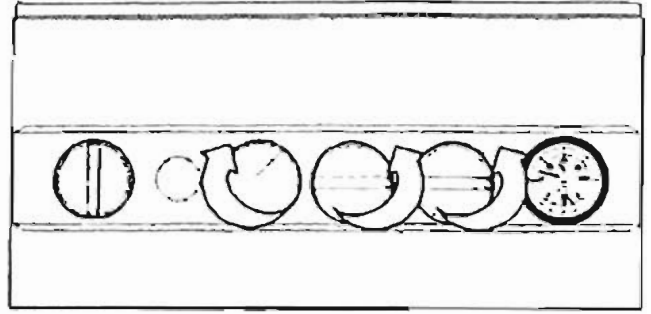

### Checking the maximum rate for central heating

- 13 close the domestic hot water cock.
- 14 turn the selector switch in d n w. -heating position;
- 15 check the maximum gas pressure and refer to the diagram shown here to determine pressure for the heating output you need;  
If the pressure is wrong it should be adjusted as instructed in sect. 5.31 at page 36.
- 16 switch off the appliance.
- 17 securely close the pressure tap

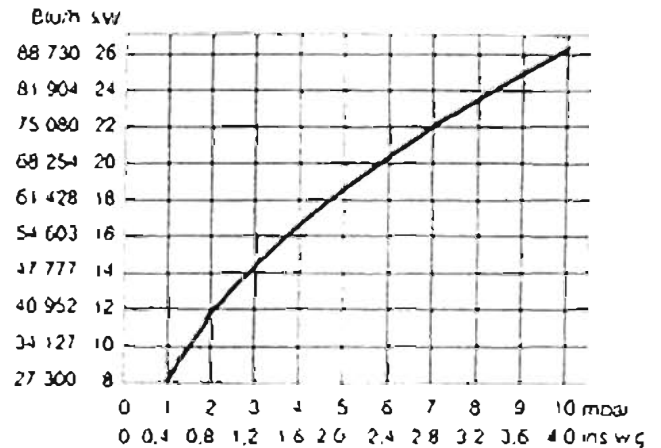

## 4.9 Checking the flue system

The flue system should be visually checked for soundness. Check all gaskets and fixings are secure and tight.

## 4.10 Checking the operation of the flame failure device

- 1 With the burner on high flame close the gas cock turning the knob in a clockwise direction,  
about 25 seconds after, a click must be heard from the gas control valve.  
Open the gas cock and ensure that gas does not flow through the pilot burner.



### 4.11 Testing the d.h.w. system flow

This appliance does not require particular regulations on d.h.w. function;

- 1 Turn the selector switch in d.h.w. only position and check the switching flow rate that should be about 2 l/s/min (0.44 gals/min).
- 2 If the cold supply is subject to large fluctuations or is above the permitted max. water pressure, a suitable pressure/flow regulator should be fitted in the d.h.w. flow switch.



### 4.12 Instructing the user

- 1 Hand over the *User's guide* supplied with the appliance and explain how to use the unit in both heating and hot water modes;
- 2 Take the User step by step through the lighting instructions;
- 3 show the User how to switch off the appliance quickly and indicate the position of the electric supply isolator;
- 4 explain the proper use and adjustment of all system controls; this will ensure the greatest possible fuel economy;
- 5 explain the function and use of the d.h.w. only -off- d.h.w. and heating selector switch;
- 6 explain and demonstrate the function of time and temperature controls (if fitted);
- 7 explain how to turn off the appliance for both short and long periods and advise on the precautions necessary to prevent damage should the appliance be inoperative when freezing conditions may occur;
- 8 finally, advise the User that, for continued safe and efficient operation, the appliance must be serviced by a competent person at least once a year.

## 5 SERVICING INSTRUCTIONS

### 5.1 General

To ensure efficient safe operation of the appliance it is necessary to carry out routine servicing at regular intervals.

The frequency of servicing will depend upon the particular installation conditions and the use to which the boiler is put, but, in general, once per year should be adequate.

The following instructions apply to the appliance but it should be remembered that the central heating and d h w systems will also require attention from time to time.

### WARNING

before starting any servicing work, switch-off the mains electricity supply and disconnect the plug at the main Isolating switch and socket (if a switch is used remove the fuse).

After any service on electrical components follow the instructions in the British Gas Multi Meter Book for preliminary electrical checks; in particular:

earth continuity;

polarity;

resistance to earth.

### 5.2 To gain general access

All testing and maintenance operations on the water heater require the control panel to be opened. These operations also require the removal of the panels which make up the case.

#### Opening the control panel

The control panel is held in the closed position by two movable rods located on the left-hand and right-hand sides of the panel.

To open the panel proceed as follows :

- 1 hold it in position and rotate the rods 90° using a screwdriver;
- 2 rotate the panel .

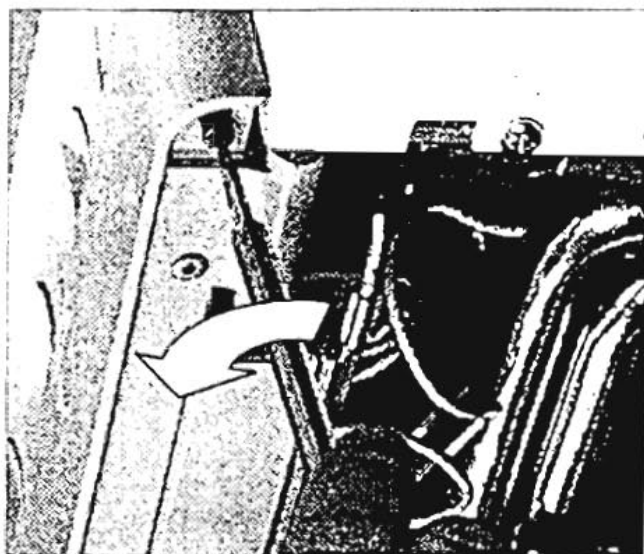
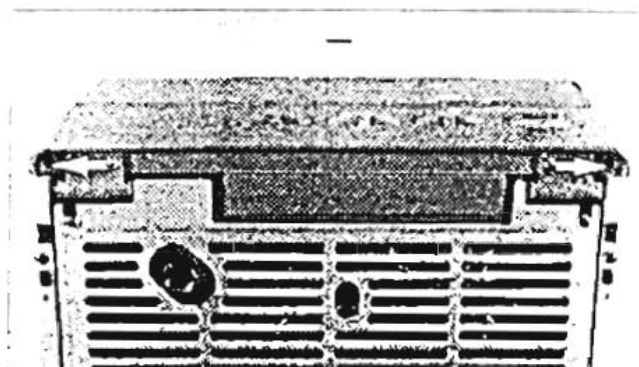

## Service instructions

### Removing the case

The front panel of the case is attached to the side panels by two screws.

To remove the front panel, proceed as follows:

1. Remove the mounting screws at the side panels.
2. Move the lower part of the front panel away from the unit.
3. Raise the panel slightly and then remove it.

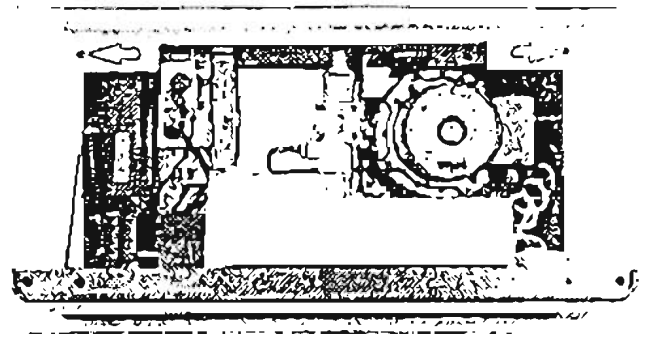

To remove the side panels which make up the case, loosen the lower screws "A" and proceed in the same way, as for the front panel.

### Removing the grille

To remove the grille, loosen the screws "B" and move the grille toward the wall.

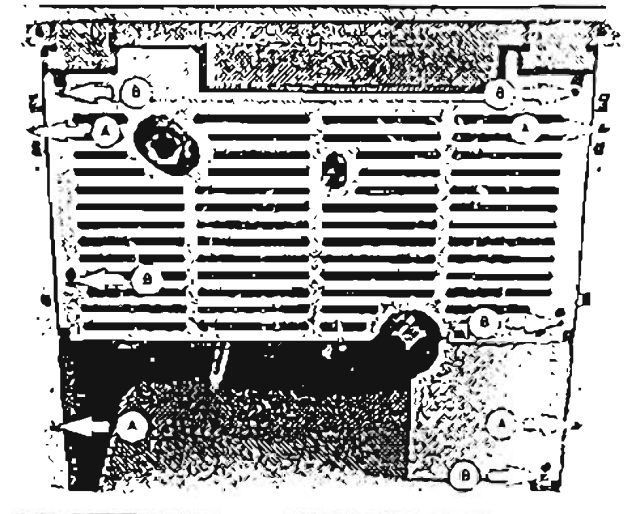

### Opening the combustion chamber

1. Remove the front panel of the case (sect. 5.2).
2. Remove the four screws.
3. Remove the front panel and open the combustion chamber.

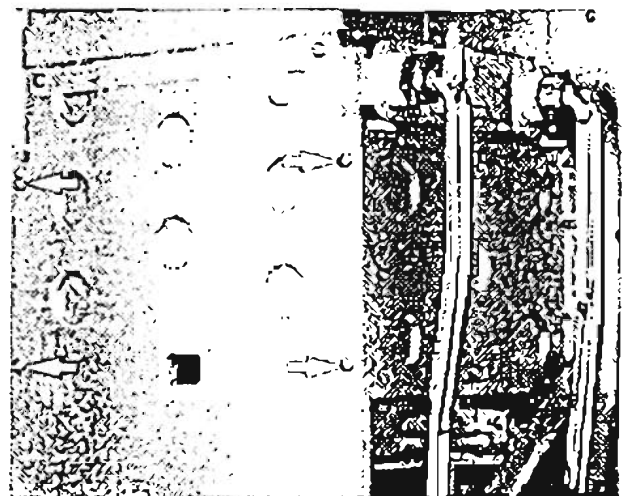

## 5.3 To drain the main circuit

1. Close central heating flow and return cocks.

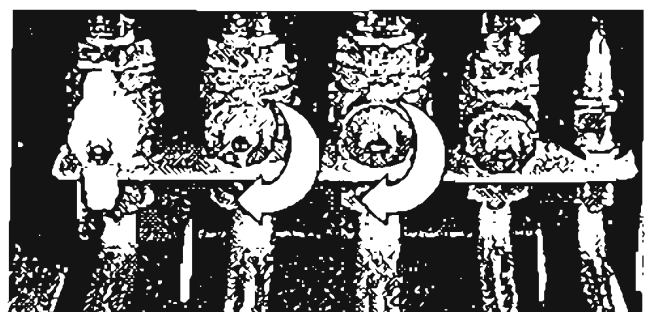

## Servicing instructions

- 2 open the digital lock on the air circuit
- 3 open the manual vent lock plate near the main heat exchanger fan connector

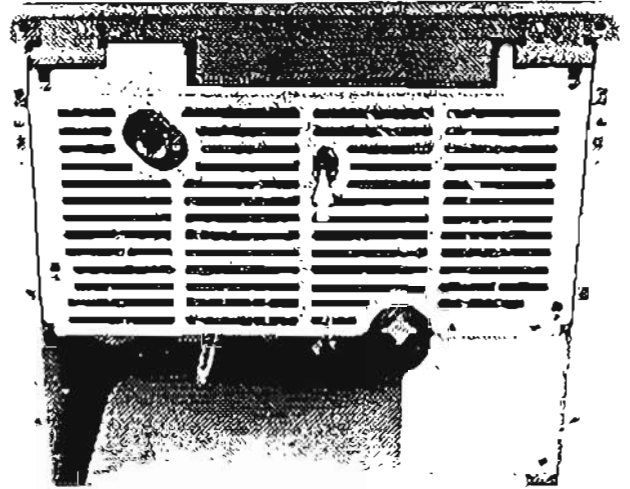

### 5.4 To drain the d.h.w. circuit

- 1 Close the cold water inlet valve
- 2 Open the drain tap of the water supply and a drain off tap
- 3 To speed drainage, open the cold water inlet connector

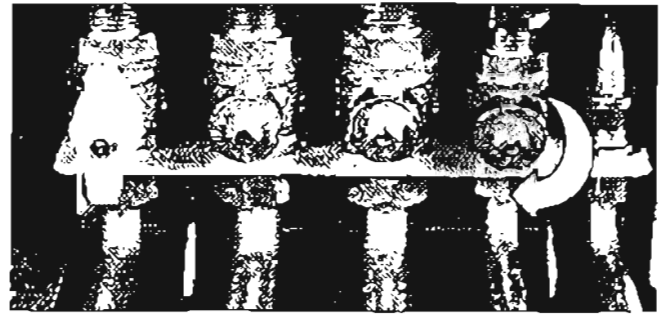

### 5.5 To remove the regulation circuit board

- 1 Ensure electricity is switched off at main isolator
- 2 open the control panel (sect. 5.2)
- 3 unscrew the two nuts "A" and remove the protective plastic cover "E"

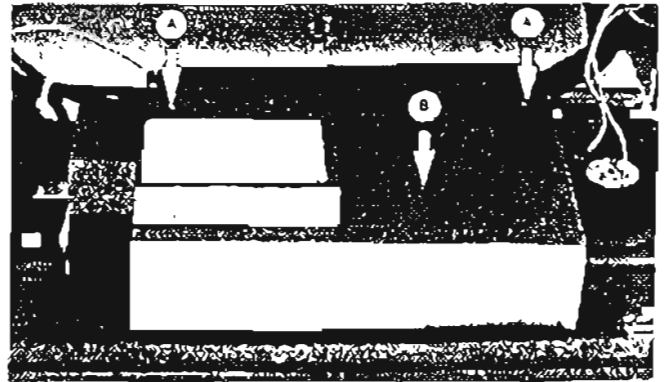

- 4 Disconnect the wires from the main terminal strip "A". Be sure to note the position of each wire as it is removed.
- 5 Disconnect the connectors "B" which are connected to the electrical components on the appliance.
- 6 Remove the mechanical connecting shafts "C" from the potentiometers.
- 7 Loosen the screws "D" and the nuts "E" which hold the circuit board on the control panel.
- 8 Remove the electronic regulation circuit board.
- 9 Reassemble in reverse order.

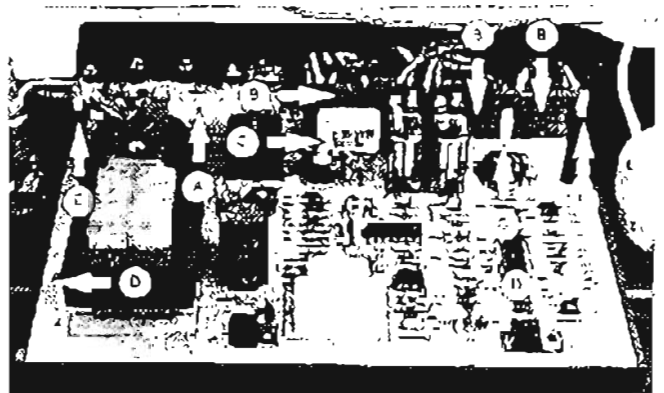



## 5.6 To remove flue fan and venturi device

1. Ensure electricity is switched off at main isolator
2. Remove the front panel (sect. 5.2):
3. Remove the three screws and open the box which houses the air switch. This box is located on the upper left hand side of the appliance.

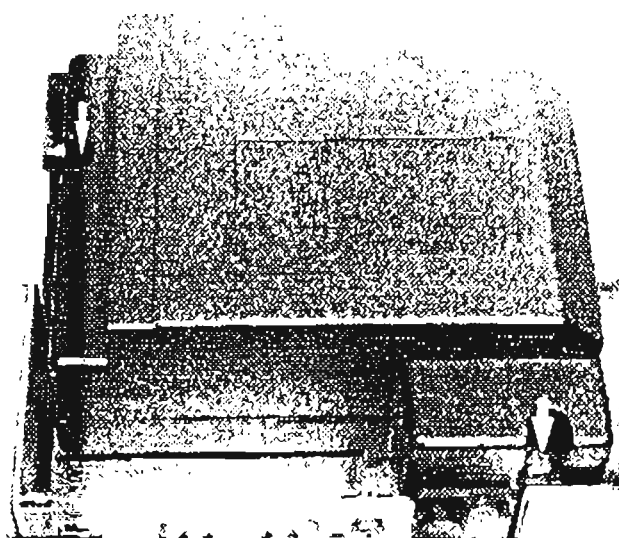

4. Disconnect the four electrical connectors, two power connections and two connections to the capacitor.

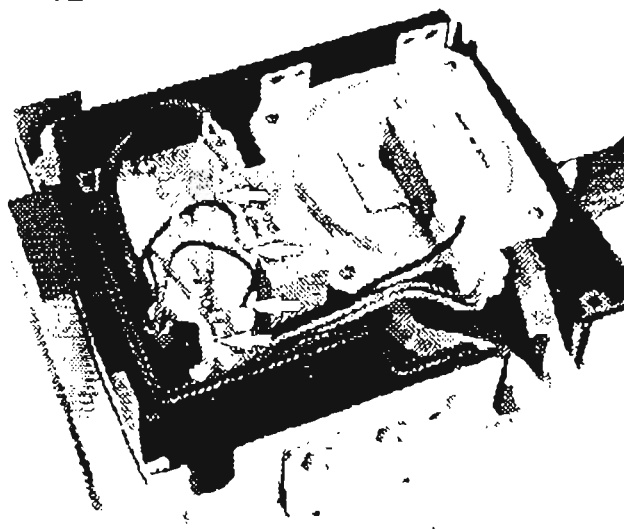

5. Remove the connecting tube which leads to the air switch.
6. Remove the four screws (A) which hold the fan to the hood.
7. Remove the fan by carrying it downwards. The venturi tube will pass along with the fan.
8. Remove the venturi device by loosening its mounting strap "B".
9. Re-assemble in reverse order.

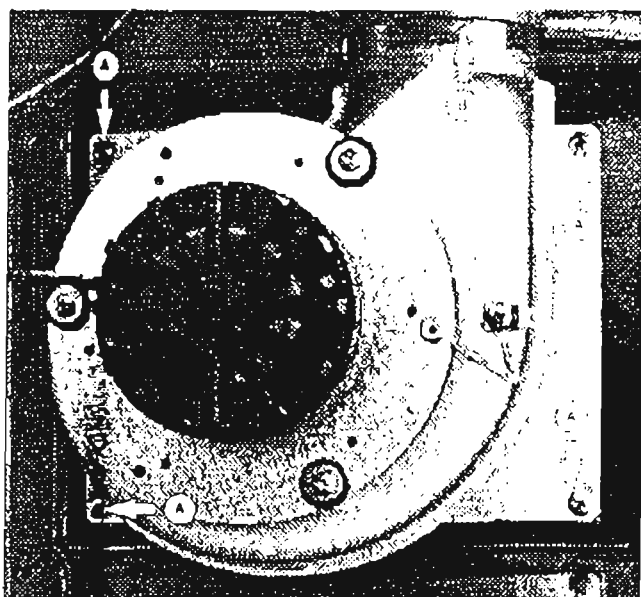

**5.7** To remove the air switch

- 1 Ensure electricity is switched on at main isolator.
- 2 open the box which houses the flue pressure switch (see sect 5.6 pt 3).
- 3 disconnect the electrical connectors "A"  
Be sure to note the positions of the wires to avoid making wrong connections during re-assembly
- 4 remove the connecting tube "B" which leads to the venturi device.
- 5 remove the air switch
- 6 reassemble in reverse order

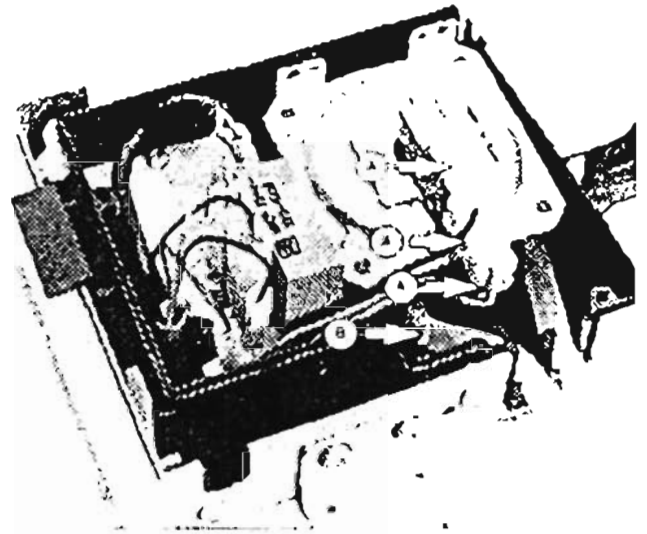

**5.8** To remove the pilot burner

- 1 Ensure electricity is switched off at main isolator
- 2 remove the front panel and open the combustion chamber (sect 5.2).
- 3 loose the mounting connector "A" and remove the lighter electrode before loosening the central mounting connector "B" to avoid breaking the electrode.
- 4 remove the mounting connectors "B" and "C"
- 5 unscrew the screw "D" and remove the pilot burner.
- 6 reassemble in reverse order

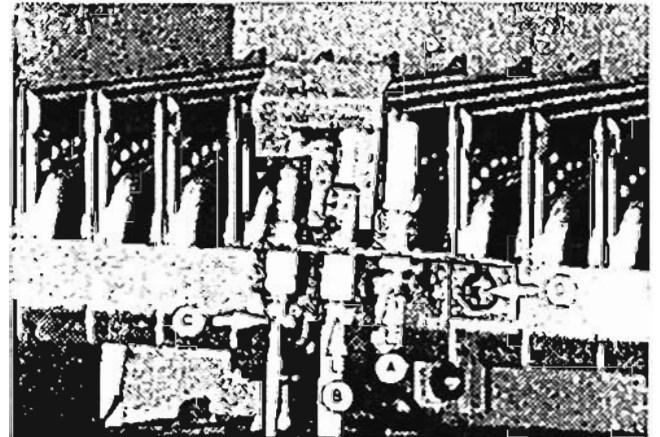

**5.9** To remove the thermocouple

- 1 Ensure electricity is switched off at main isolator.
- 2 remove the front panel and open the combustion chamber (sect. 5.2);
- 3 loosen the connector "A" which holds the thermocouple to the pilot burner;
- 4 loosen the electrical connector "B" on the gas valve and remove the thermocouple by withdrawing it downwards
- 5 reassemble in reverse order

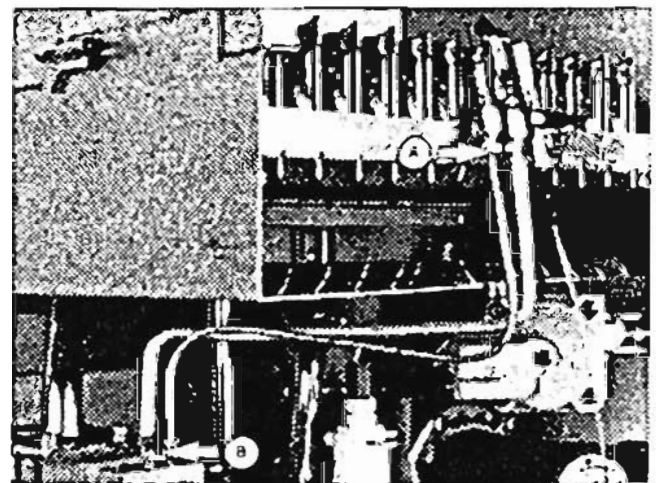

**5.10** To remove injectors

- 1 Remove the burner ramp unit (sect 5.11).
- 2 unscrew injectors.
- 3 reassemble in reverse order.

Removing injectors, metallic gaskets must be replaced

### 5.11 To remove burner ramp unit

1. Ensure electricity is switched off at main isolator.
2. Remove the front panel and open the combustion chamber (sect. 5.2).
3. Remove the screw "A" and move the pilot burner away from the ramp unit.
4. Remove the four screws "B" placed at the right and left sides of the ramp unit (one is not visible).
5. Remove the ramp unit.
6. Reassemble in reverse order.



### 5.12 To remove gas modulator

1. Ensure electricity is switched off at main isolator.
2. Remove the front panel (sect. 5.2).
3. Disconnect the two wires "A".
4. Loosen the two screws "B" (the right one indicated) which attach the gas modulator to the on/off actuator.
5. Remove the gas modulator.
6. Reassemble in reverse order.

The wires to the gas modulator can be inverted without affecting the operation of the water heater.

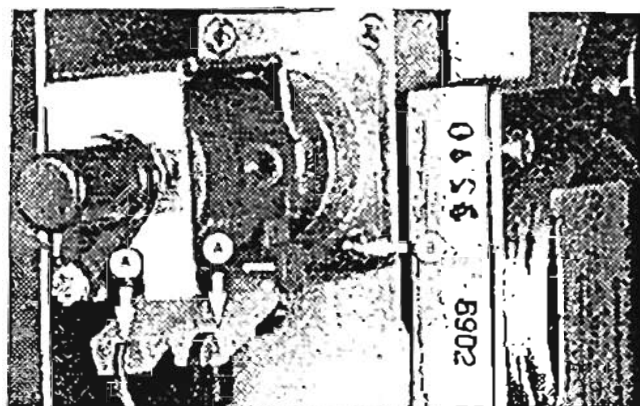

### 5.13 To remove the modulating gas valve

1. Ensure electricity is switched off at main isolator.
2. Remove the front panel (sect. 5.2).
3. Disconnect the two wires to the gas modulator.
4. Remove the protective cover "A" from the terminals on the on/off actuator and disconnect the wires.
5. Unscrew the connector "B" (rear side of the gas control valve) and the connector to the thermocouple.
6. Completely unscrew the 8 grub-screws "C" which join the gas valve to the flanges of the gas inlet and exit pipes.
7. Remove the gas valve.
8. Reassemble in reverse order.

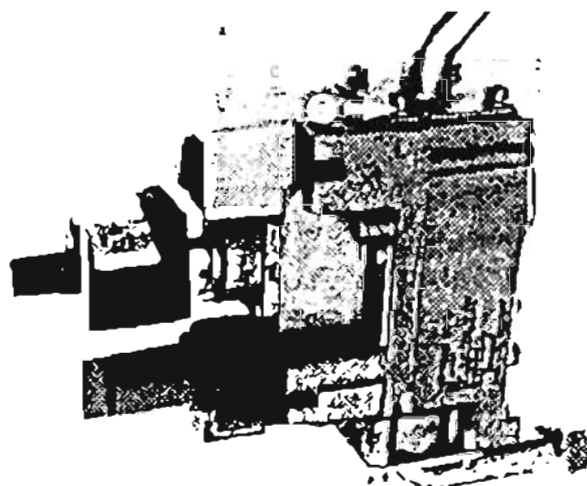

### 5.14 To remove the safety thermostat

1. Ensure electricity is switched off at main isolator.
2. Remove the front panel and the right panel (sect. 5.2).
3. Loosen the connectors on the gas control valve.
4. Remove the two screws which attach the safety thermostat to the pipe of the primary water circuit.
5. Remove the safety thermostat with its electrical wires.
6. Reassemble in reverse order.

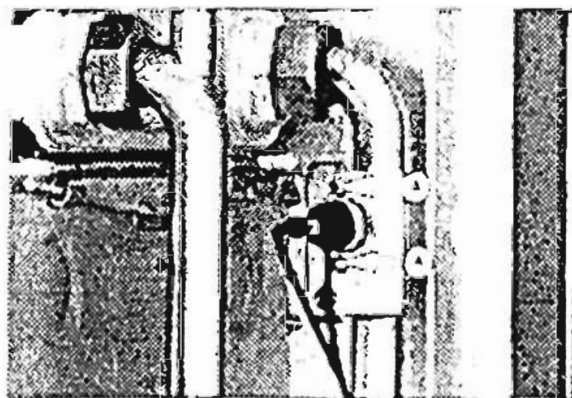

**5.15** To remove main heat exchanger

- 1 Ensure electricity is switched off at main isolator;
- 2 remove the front panel, the right panel and open the combustion chamber (sect. 5.2);
- 3 drain the main circuit (sect. 5.3);
- 4 unscrew the connections "A" on the inlet and outlet pipes and remove the springs "B" (the right one indicated), which hold the exchanger against the two side panels of the combustion chamber, by forcing the ends of the springs upwards;
- 5 remove the exchanger by pulling it toward the front of the appliance;
- 6 reassemble in reverse order.

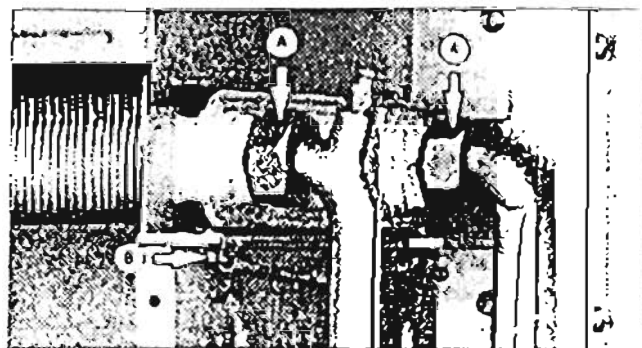

**5.16** To remove d.h.w. heat exchanger

The d.h.w. heat exchanger may be carried out in two ways, according to the manner in which the appliance is installed

- from the top if at least 40 cm (15,7 ins) of free space are available between the appliance and any obstacle above the appliance;
- toward the side (right-hand side) if at least 13 cm (5,1 ins) of free space are available between the appliance and any obstacle to the right side.

- 1 Ensure electricity is switched off at main isolator;
- 2 drain the main and d.h.w. circuits (secs. 5.3 and 5.4);
- 3 remove the upper bracket "A" by loosening the screw "B" which holds the bracket to the chassis;
- 4 disconnect the d.h.w. outlet "C";

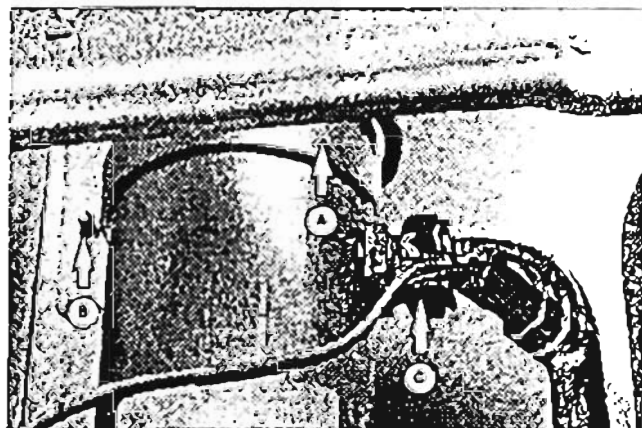

- 5 disconnect the water inlet connector "A";
- 6 remove the collars which join the heat exchanger to the water deviation body by completely loosening the screws "B";
- 7 remove the exchanger;
- 8 reassemble in reverse order.

When replacing the d.h.w. heat exchanger, be sure to pay attention to the reference notch on the lower edge of the exchanger shell; this notch must be lined up with a similar notch on the water deviation body.

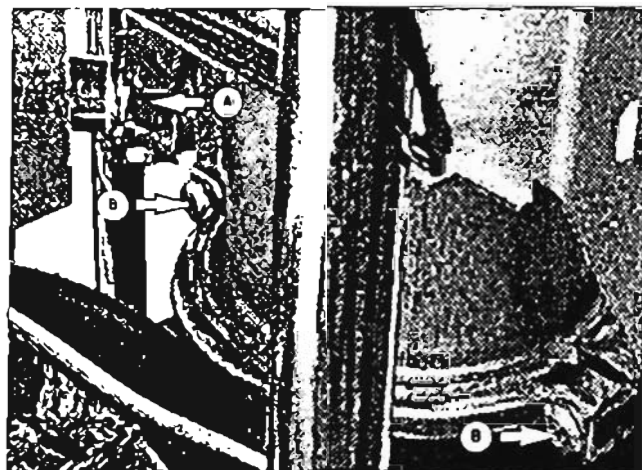

### 5.17 Maintenance of d.h.w. heat exchanger

The following basic maintenance operations for the secondary heat exchanger will be described in detail:

- maintenance of the plug
- maintenance of the complete heat exchanger

#### Removing the plug

Maintenance operations can be carried out directly on the plug without completely removing the secondary heat exchanger from the appliance.

- 1 Remove the fork;
- 2 use a screwdriver to pry between the shell and the air discharge valve at a number of different points.
- 3 lift the plug and the valve upwards

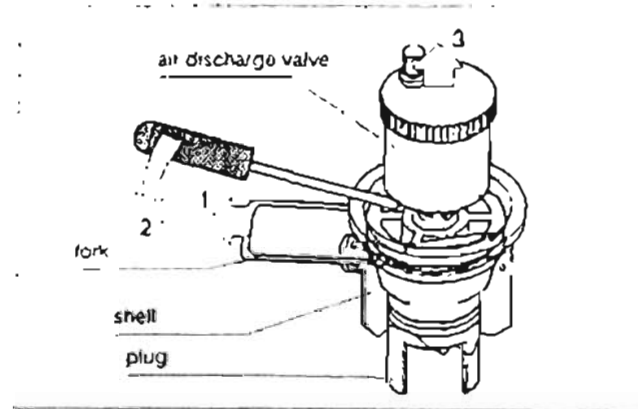

#### Installing the plug

Follow the procedure below to install the plug on the secondary heat exchanger:

- 1 Install O-rings "a" and "b" on the grooves in the plug.
- 2 install O-ring "c" into the upper flaring of the bellows
- 3 insert the plug by rotating it until the fork can be installed.
- 4 insert the fork.

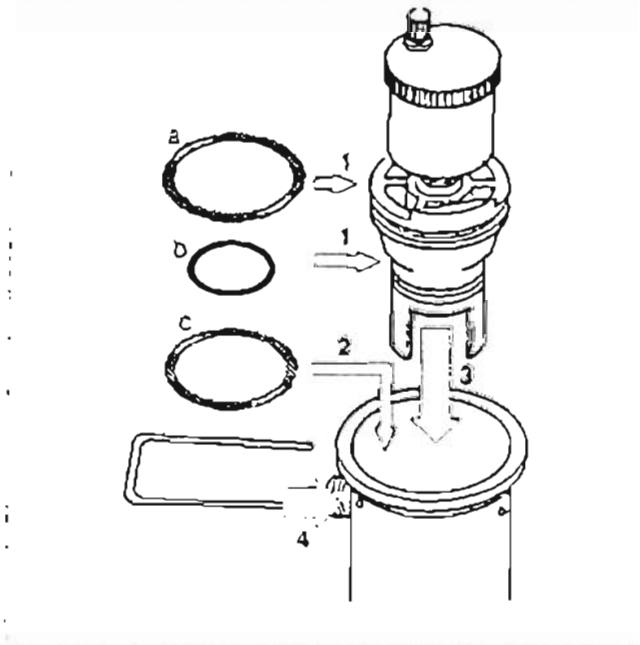

#### Disassembling the secondary heat exchanger

- 1 Remove the d.h.w. heat exchanger from the appliance (sect. 5.16);
- 2 Remove the plug;
- 3 Remove the O-rings from the plug;
- 4 use the plug to extract the bellows from the bottom of the shell.

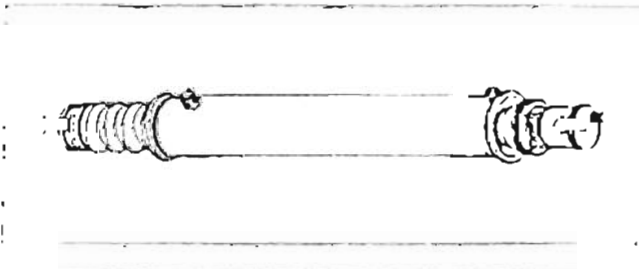

#### Re-assembling the secondary heat exchanger

- 1 Position the O-ring gaskets on the lower end of the bellows;
- 2 insert the bellows into the shell and use the plug, without O-rings, to force the bellows into its final position;
- 3 Install the plug;

Note: Avoid deformation of the bellows to assure proper sealing by the O-ring gaskets.

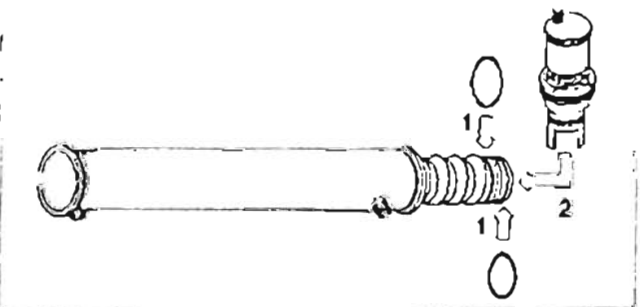

**5.18** To remove NTC probe on d.h.w. circuit

- 1 Ensure electricity is switched off at main isolator.
- 2 drain the d.h.w. circuit (sect. 5.4)
- 3 disconnect the electrical cables from NTC probe.
- 4 unscrew NTC probe from its pipe
- 5 remove it.
- 6 reassemble in reverse order

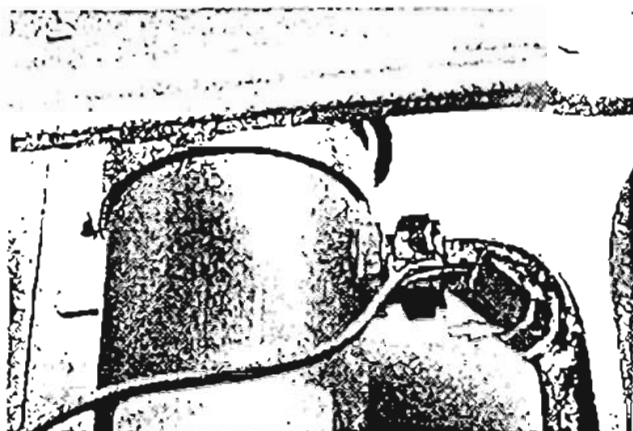

**5.19** To remove NTC probe on main circuit

- 1 Ensure electricity is switched off at main isolator.
- 2 remove the front panel and the right panel (sect. 5.2).
- 3 drain the main circuit (sect. 5.3)
- 4 disconnect the electrical cables "A"
- 5 unscrew NTC probe "B" from its pipe.
- 6 remove it.
- 7 reassemble in reverse order

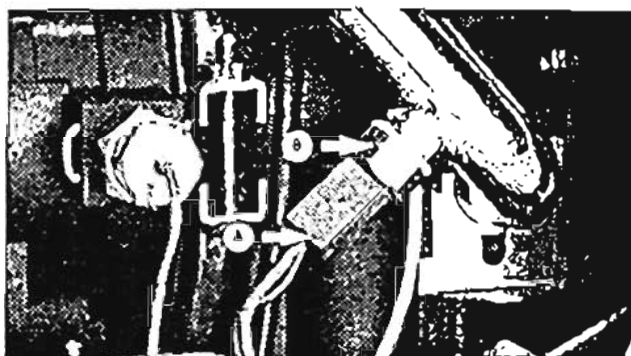

**5.20** To remove circulator

- 1 Ensure electricity is switched off at main isolator.
- 2 remove the front panel, the right panel and open the control panel (sect. 5.2).
- 3 drain the main circuit (sect. 5.3).
- 4 open cover "A" which protects the electrical terminals and disconnect the electrical power cables from the circulator
- 5 completely loosen the four screws indicated with a circle which attach the circulator to the volute (scroll).
- 6 remove the circulator

Re-assembling the circulator

- 1 Carefully clean the supporting seat for the flat gasket.
- 2 correctly position the gasket in the seat on the volute (scroll).
- 3 correctly position the circulator and the mounting flange.
- 4 insert the four mounting screws.
- 5 tighten the four screws until they meet resistance but do not allow the screws to exert any pressure whatsoever on the flange.
- 6 tighten down the four mounting screws completely in the sequence shown in the figure

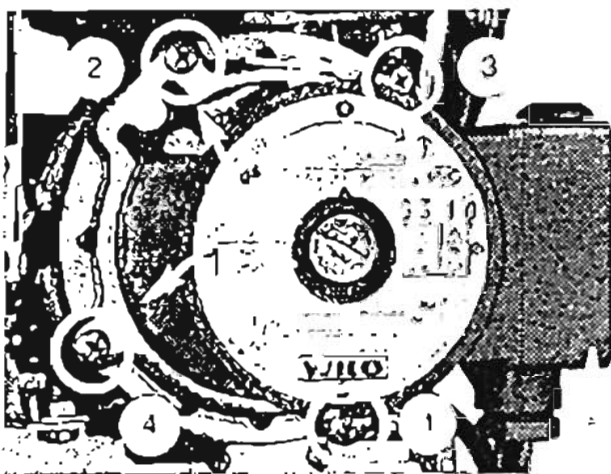

### 5.21 Maintenance of d.h.w. flow switch

Three types of basic maintenance are prescribed for this flow switch:

- Substitution of the float and/or the plug-sensor
- Cleaning of the filter and/or insertion of the flow limiter
- Complete substitution of the flow switch

#### Substitution of the float and/or the plug-sensor.

- 1 Ensure electricity is switched off at main isolator.
- 2 remove the front panel (sect. 5.2);
- 3 drain the d.h.w. circuit (sect. 5.4);
- 4 remove the upper fork "A";
- 5 remove plug "B" by prying the plug upwards.
- 5 extract the float using a properly shaped piece of iron to attract the magnet inside the float.
- 7 reassemble in reverse order

Be sure to note that the float must be installed with the non-circular side (with the word "ALTO" in relief) oriented toward the top of the unit.

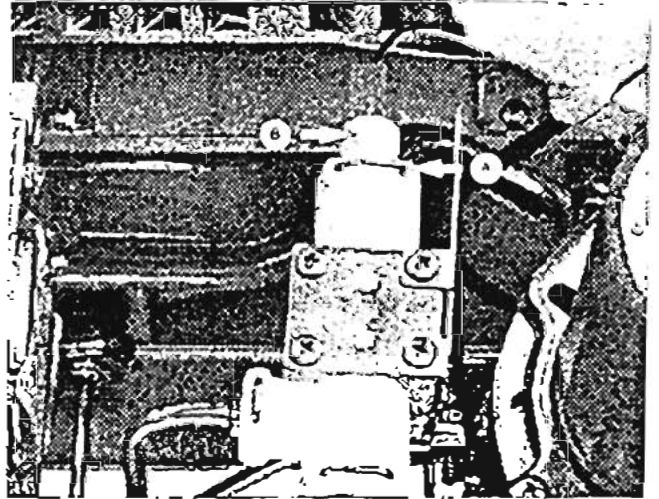

#### Cleaning of the filter or insertion of the flow limiter

- 1 Ensure electricity is switched off at main isolator.
- 2 remove the front panel and the grille (sect. 5.2).
- 3 drain the d.h.w. circuit (sect. 5.4);
- 4 completely loosen the inlet connector "A" to the domestic hot water circuit.
- 5 remove the lower fork "B" on the flow switch.
- 5 remove the pipe support spline by loosening the two screws "C" which hold the spline to the bracket.
- 7 remove inlet pipe "D" by gently pulling it downwards.
- 8 reassemble in reverse order.

When re-assembling this unit, make sure that flow limiter (if fitted) is installed as shown.

#### Complete substitution of the flow switch

- 1 Ensure electricity is switched off at main isolator.
- 2 remove the front panel and the grille (sect. 5.2).
- 3 drain the d.h.w. circuit (sect. 5.4);
- 4 completely loosen the inlet connector "A" for the d.h.w. circuit.
- 5 remove the pipe support spline by loosening the two screws "C" which hold the spline to the bracket.
- 5 remove the flow switch.
- 7 reassemble in reverse order

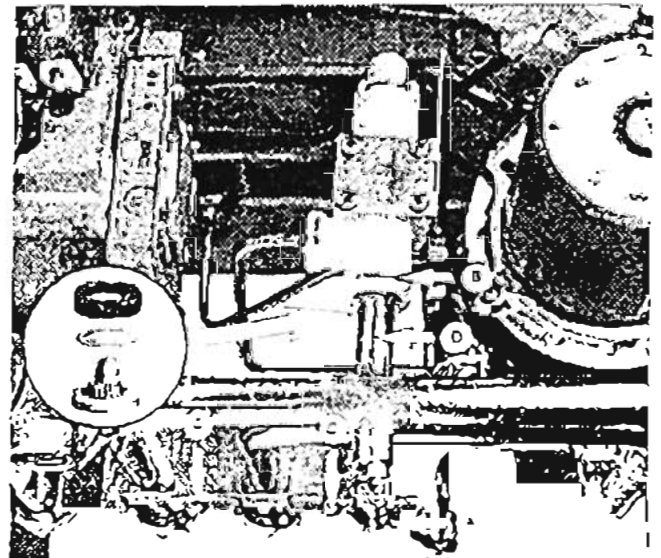

**5.22** To remove main circuit flow switch

- 1 Ensure electricity is switched off at main isolator;
- 2 remove the front panel and the right panel (sect. 5.2);
- 3 drain the main circuit (sect. 5.3);
- 4 completely loosen the two screws "A";
- 5 open cover "B" which protects the microswitch;
- 6 disconnect the electrical connections;
- 7 loosen the two screws which attach the pressure switch to the pipe;
- 8 remove the flow switch;
- 9 reassemble in reverse order.

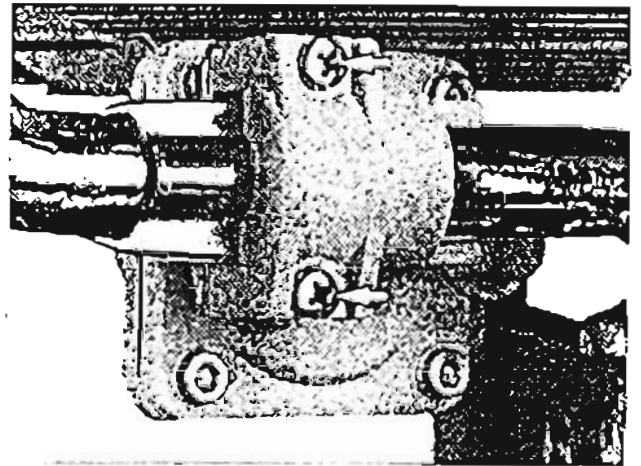
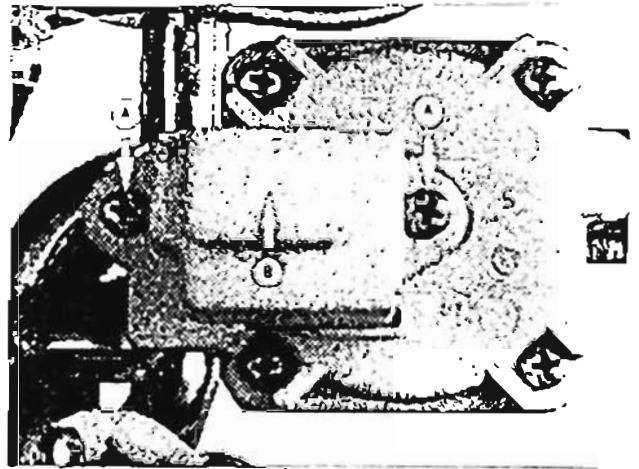

**5.23** To remove temperature-pressure gauge

- 1 Ensure electricity is switched off at main isolator;
- 2 open the control panel and remove grille (sect. 5.2);
- 3 drain the main circuit (sect. 5.3);
- 4 remove pressure gauge pipe "A" by loosening the connector to the volute (scroll);
- 5 remove thermometer bulb "B" from the outlet pipe on the main heat exchanger;
- 6 remove the temperature-pressure gauge from the control panel by pressing on the elastic splines which hold it in position;
- 7 reassemble in reverse order.

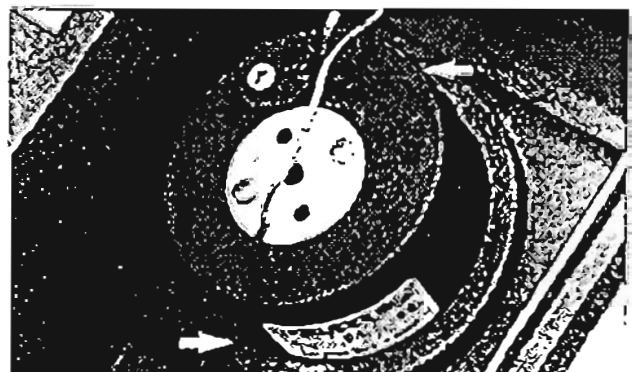
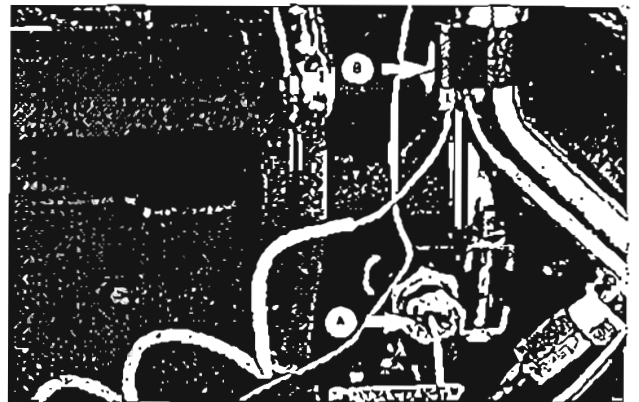



## Servicing instructions

### 5.24 To remove by-pass

- 1 Ensure electricity is switched off at main isolator, remove the front panel (sect. 5.2).
  - 2 drain the main circuit (sect. 5.3).
  - 3 remove fork indicated (back view) which holds the by-pass to the water deviation body.
  - 4 remove the by-pass from the water deviation body
- The by-pass has a profiled internal element; when assembling the valve, the two flat surfaces must be positioned horizontally

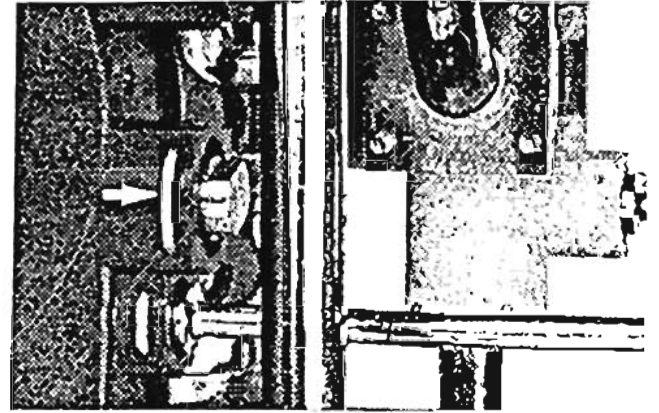

### 5.25 To remove automatic air release valve

- 1 Ensure electricity is switched on at main isolator
- 2 drain the main circuit (sect. 5.3).
- 3 unscrew the valve and remove it.
- 4 reassemble in reverse order



### 5.28 To remove main circuit expansion vessel

- 1 Ensure electricity is switched off at main isolator
  - 2 remove the front panel (sect. 5.2);
  - 3 drain the main circuit (sect. 5.3).
  - 4 completely loosen the lower connector which connects the vessel to the appliance;
- 
- 5 remove the box containing the flue switch;
  - 6 remove the upper bolt which attaches the expansion vessel to the transverse bar on the chassis;
  - 7 remove the expansion vessel from above;
  - 8 reassemble in reverse order

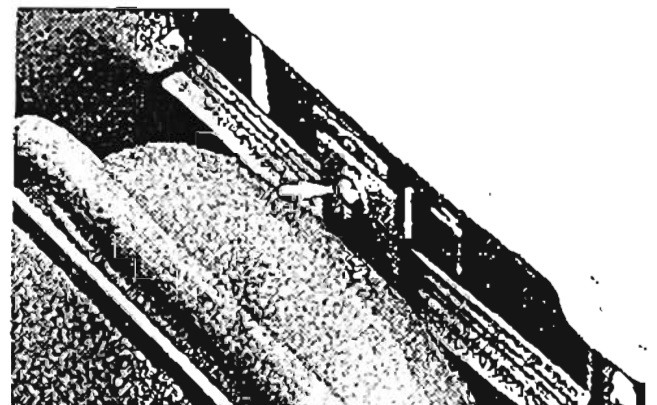
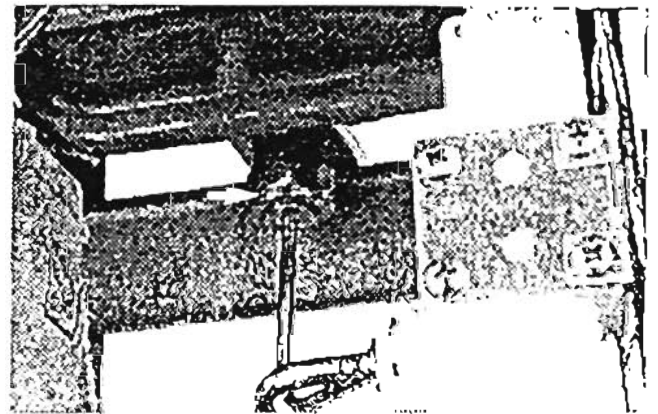

**5.27** To remove safety valve

- 1 Ensure electricity is switched off at main isolator;
- 2 open the control panel and remove grille (sect 5.2);
- 3 drain the main circuit (sect 5.3);
- 4 unscrew the valve and remove it;
- 5 reassemble in reverse order

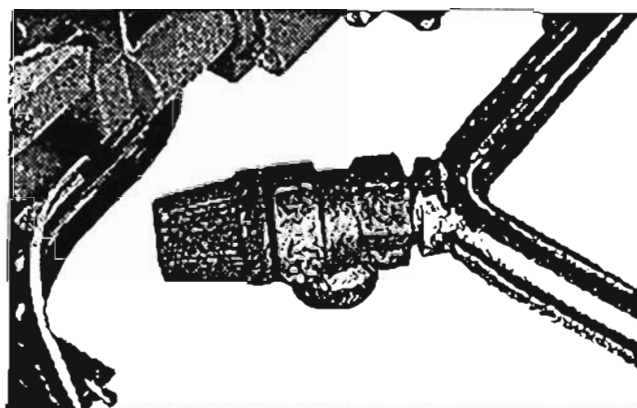

**5.28** To remove 3-way valve

- 1 Remove the water unit from the appliance (sect. 5.29);
- 2 move lever "A" to the "manual" position;
- 3 completely loosen the screw "B" and remove the cover from the 3-way valve;

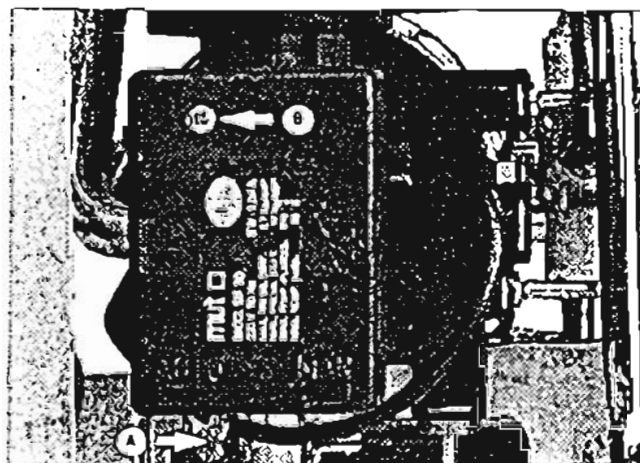

- 4 disconnect the electrical connections (both power and ground connections);
- 5 remove the four screws "C" which attach the valve to the water deviation body;
- 6 reassemble in reverse order.

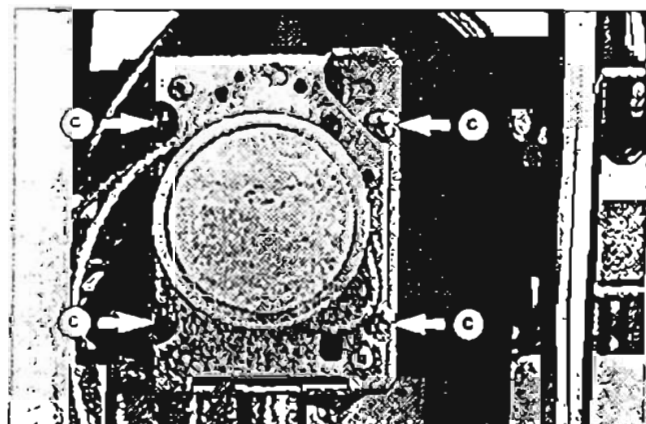

**5.29 To remove water unit**

The water unit is an assembly of components which can be removed from the appliance as a single unit. The unit is made up of the circulator, volute (scroll), water deviation body, heating water filter, 3-way valve, by-pass, d.h.w. heat exchanger, automatic air release valve, d.h.w. flow switch, NTC probe on d.h.w. circuit, and the heating water flow and return pipes

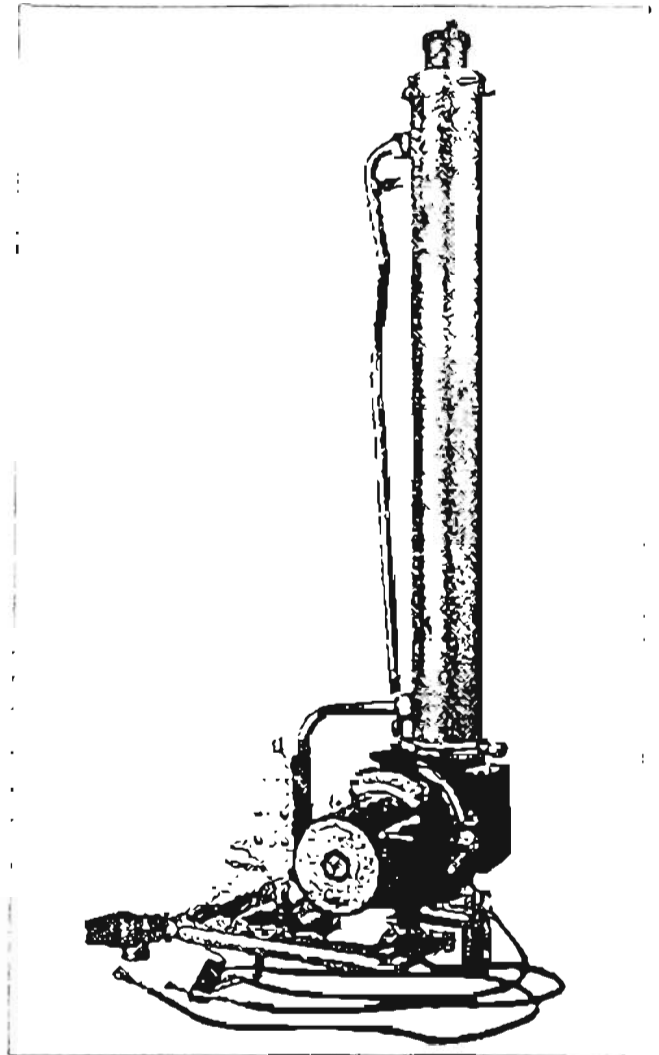

- 1 Ensure electricity is switched off at main Isolator;
- 2 remove the front panel, the right panel and the grille (sect. 5.2);
- 3 drain the main circuit (sect. 5.3);
- 4 drain the d.h.w circuit (sect 5.4);
- 5 remove the upper bracket "A" by loosening screw "B" which holds the bracket to the chassis;
- 6 disconnect the connector "C" on NTC probe;
  
- 7 remove connection collar (indicated) on the outlet from the volute (scroll).

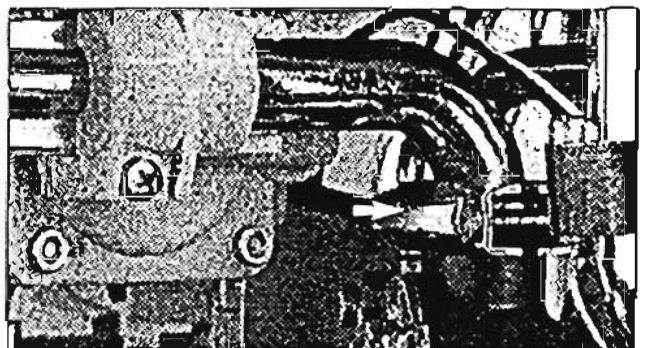
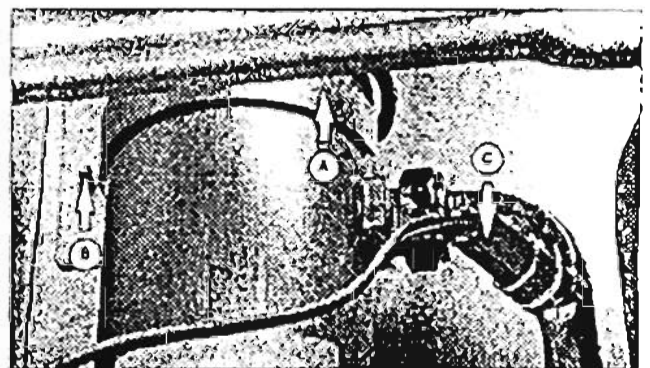

## Servicing instructions

- 8 loosen the connector on the expansion vessel "A" and remove the connection pipe "B" from the vessel to the water unit.

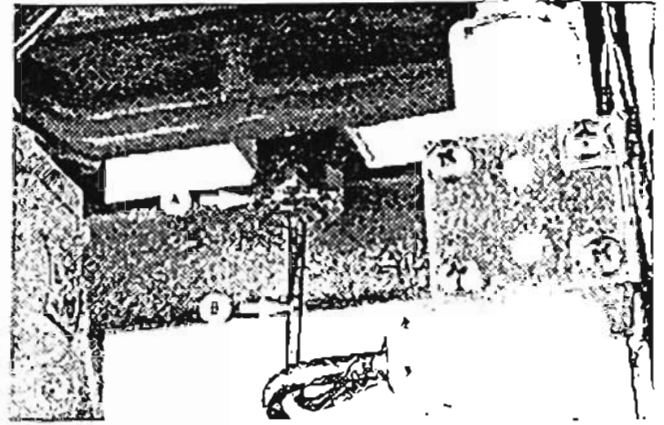

- 9 disconnect the hydrometer connecting pipe by removing the fork "A" which attaches the pipe to the volute (scroll).
- 10 remove fork "B" which holds the connecting pipe to the main heat exchanger and move the pipe away from the water deviation body.
- 11 remove the wires from the main circuit flow switch.
- 12 disconnect the connector on the d.h.w. flow switch.

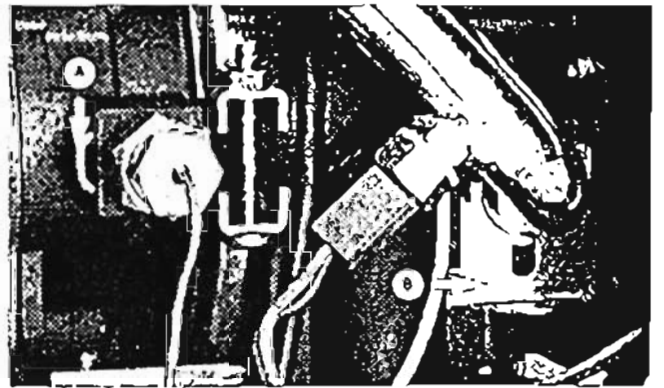

- 13 disconnect the left hand connector indicated from the electronic regulation circuit board including ground connectors.



- 14 completely loosen the four connectors "A" which connect the appliance to the d.h.w. and heating water systems.
- 15 remove the two screws "B" which attach the support bracket for the water unit to the chassis.
- 16 gently lift the water unit to release it from the chassis.
- 17 remove the water unit downwards.
- 18 reassemble in reverse order.

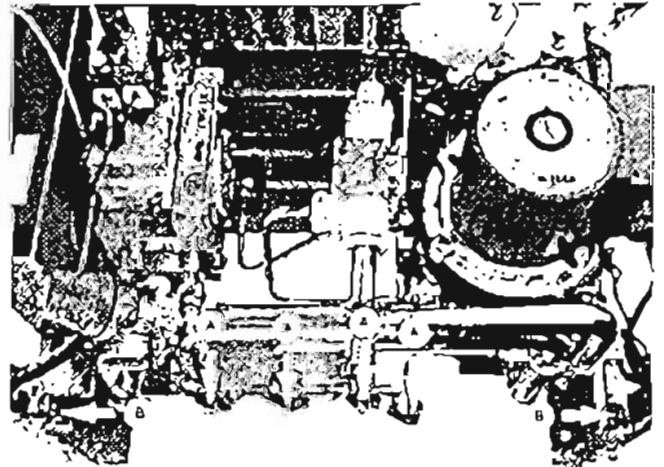

### 5.30 Setting gas pressures

#### Setting the minimum gas pressure

- 1 Ensure electricity is switched off at main Isolator;
- 2 remove the front panel (sect. 5.2);
- 3 disconnect either of the two connectors "A" from the gas modulator;
- 4 remove the protective hood from the calibration system on the gas modulator
- 5 open the exit pressure outlet and connect a manometer
- 6 switch on electricity at main isolator.
- 7 turn the selector on "d.h.w. - central heating operation" and start the appliance at its maximum heating power setting domestic hot water temperature to maximum;
- 8 rotate adjustment control "B" to adjust the minimum gas pressure to the prescribed value. Rotate the control clockwise to increase the pressure.

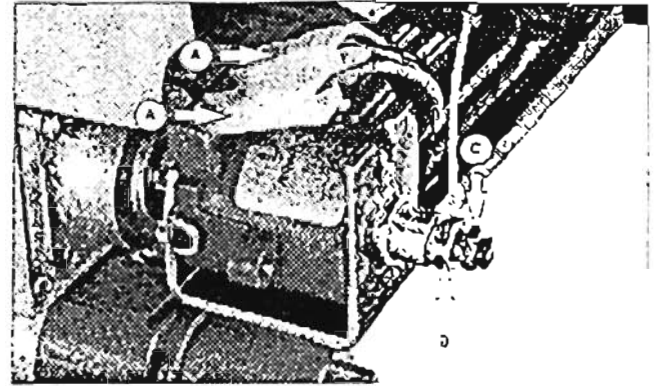

#### Setting the maximum gas pressure

- 9 Re-connect the wire to the gas modulator;
- 10 rotate adjustment control "C" to adjust to the maximum pressure prescribed value. Rotating the control clockwise increases the pressure. During this operation, be sure not to move the adjustment control "B";
- 11 make sure that both minimum and maximum gas pressures are correctly set by disconnecting and re-connecting one of the wires to the gas modulator.
- 12 install the protective hood over the calibration system on the gas modulator and close the exit pressure outlet on the gas valve.

### 5.31 Setting the max. rate for central heating system (Range rating)

- 1 Close the domestic hot water cock;
- 2 turn the central heating adjustment to its maximum position;

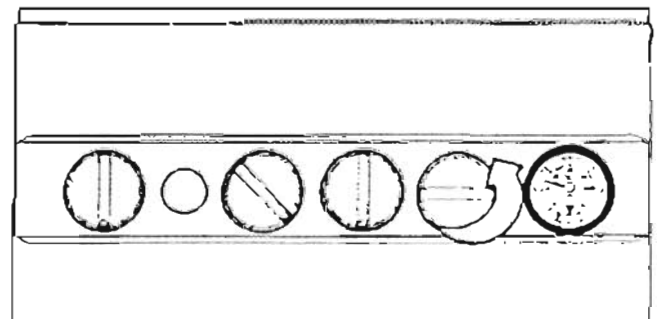

## Servicing instructions

- 3 refer to the diagram shown here to determine pressure for the heating output you need:

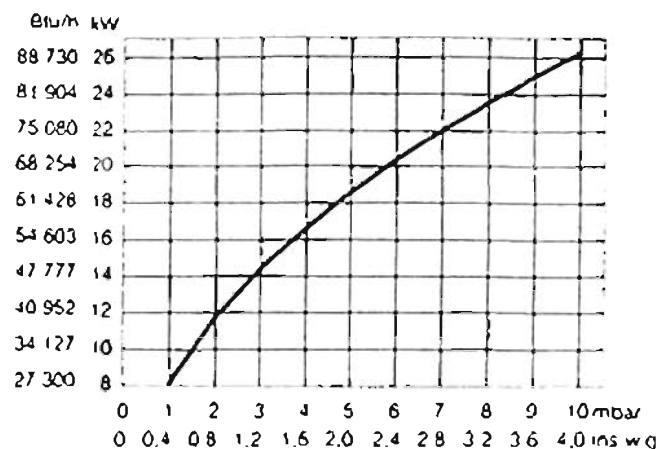

- 4 using a screwdriver, gently adjust the regulation potentiometer for desired pressure. rotating the potentiometer counter-clockwise reduces the maximum current fed to the gas modulator and thus reduces the maximum gas pressure to the burner.
- 5 securely close the pressure tap

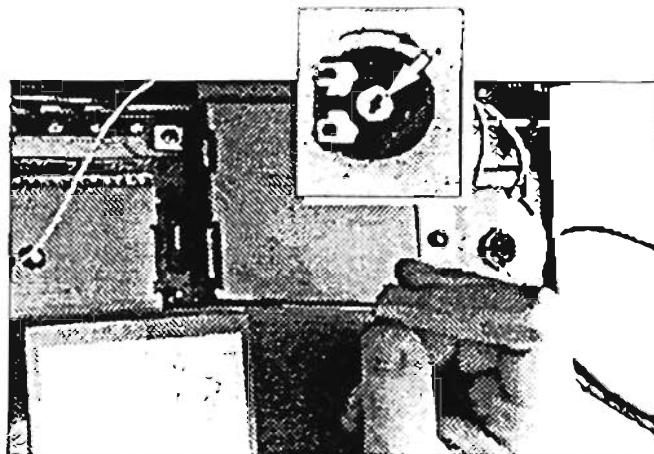

### 5.32 Adjusting the pilot burner gas feed pressure

To adjust the gas feed pressure to the pilot burner, use a screwdriver and turn the adjustment screw on the gas valve, as shown.

Rotate the screw counter-clockwise to increase the pressure.

Adjust the pressure so that the flame from the pilot burner is completely wrapped around the end of the thermocouple and the burners are not shut down by blasts of air.

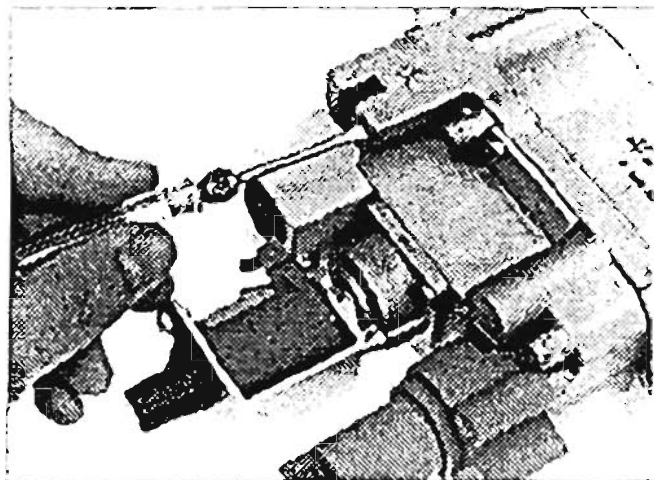



## **6** FAULT FINDING

### **6.1** Fault finding diagrams

The fault finding diagrams illustrate the proper steps to be followed when searching for the cause of improper operation.

Even though the diagrams refer to three specific cases, they can be used to diagnose most causes of improper operation.

The functions carried out by all components in the appliance are illustrated; this method of component illustration allows most cases of improper operation to be corrected.

However, a malfunction may occur which cannot be troubleshooted from the diagrams. In this case see section 6.3, "Special defects", and the paragraphs which follow it.

### **6.2** Using the fault finding diagrams

Each diagram is developed on two sides: a flow chart of the operating logic of the appliance is printed on the left, while additional details concerning the flow chart are printed on the right.

The questions which follow the start point (located inside a rhomb) must be answered by YES or NO according a test carried out on the appliance. Each YES or NO answer leads to a specific path in the fault finding process, and each path eventually reaches a list of probable causes for the malfunction.

### **6.3** Special defects

The following types of defects are not indicated on the fault finding diagrams, each of these problems is treated in its own section:

- water leaks;
- difficulty in lighting gas;
- problems with modulation or combustion;
- traces of gas or exhaust gases in the installation area

### **6.4** Water leaks

#### **Leaks from connectors, O-rings or gaskets**

Make sure that the surfaces which come into contact with the gaskets are free from dirt, roughness or deformation.

Then, substitute the gasket (both O-ring and flat gaskets).

#### **Water leaks from the safety valve**

Make sure that the water meter is correctly reading the amount of water being used. Remove the d.h.w. heat exchanger and check the bellows for leaks. If necessary, substitute the safety valve.

If the leak only occurs when the appliance is operating, empty the main water circuit and check the pressure applied to the expansion vessel (see section 4.29, "Expansion vessel"). Make sure that the water meter is correctly reading the amount of water being used.

### **6.5** Difficulty in lighting gas

Make sure that input and output pressures on gas valve are set to the correct values.

Also, make sure that no pressure variations are being caused by a malfunctioning component (defective pressure reducers or regulator, dirty gas filters; other gas consuming equipment installed on the same gas line, etc.)

Make sure that injectors are clean.

### **6.6** Problems with modulation or combustion

Make sure that the modureg has been set correctly and make sure that the following elements are clean:

- burner;
- combustion chamber;
- flue system.

### **6.7** Traces of gas or exhaust flues in the installation area

If gas is detected in the installation area, use a soap solution or a specific leak-detection product to make sure that all the gas connectors in the system are perfectly sealed. Check for leaks when the appliance is shut down and during operation.

If exhaust flue is detected in the installation area, make sure that the exhaust duct has been built to the exact specifications prescribed. Also, check the exhaust duct for leaks and make sure that it is clean. Make sure that all exhaust duct-work conforms to current technical standards.



# Fault finding

General operating malfunction  
(appliance completely shut down)

Initial conditions:

- the heating circuit is adequately filled;
- the appliance is in the "d n w - heating" mode;
- the thermostat or timer is closed ref. 1;
- sufficient gas is being fed to the boiler.

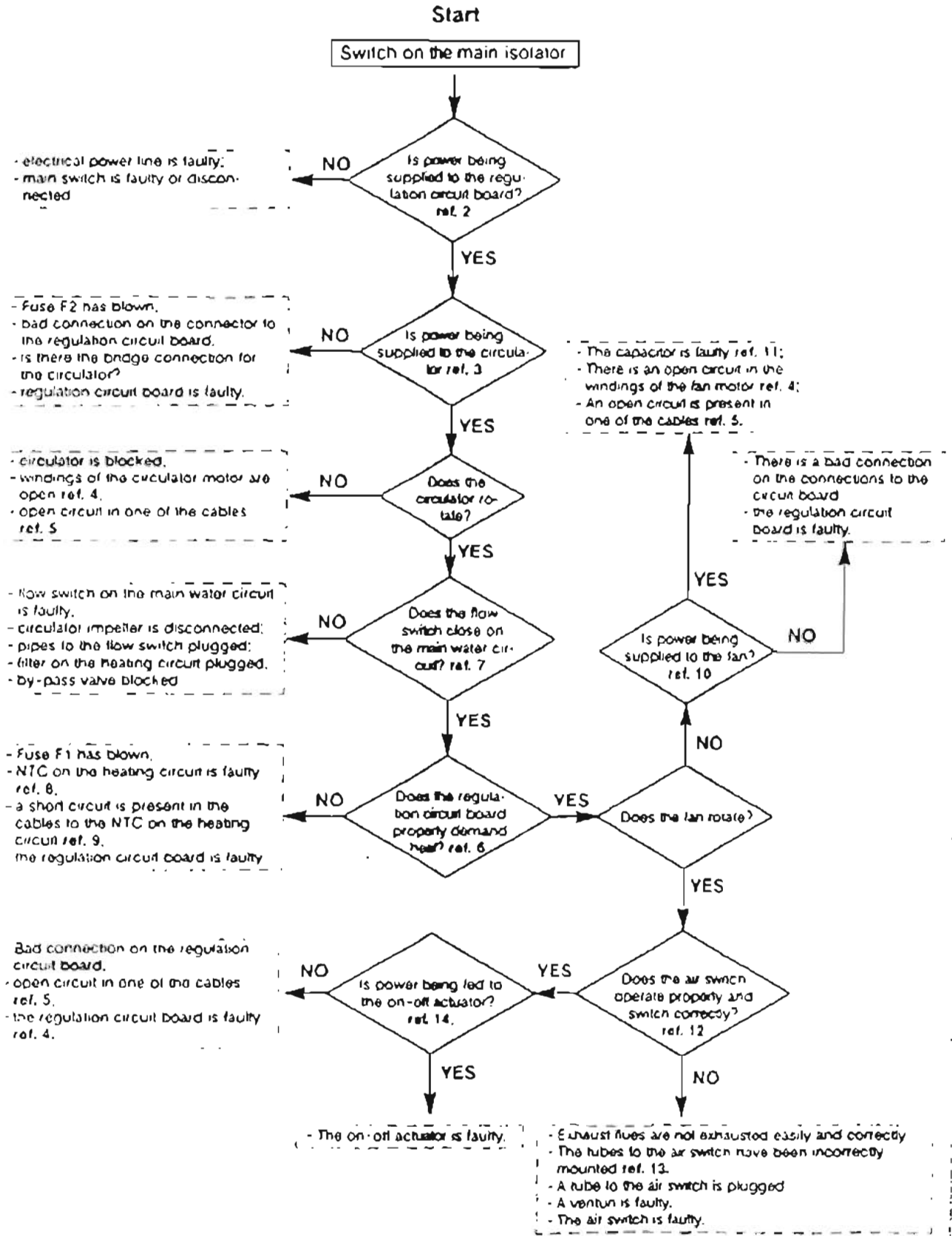

## Fault finding

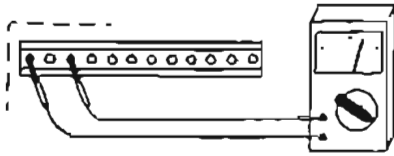

ref 1 Supply voltage should be indicated when the appliance is started and when the thermostat or timer is open.

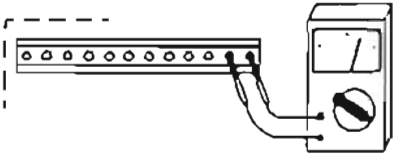

ref 2 Supply voltage should be indicated when power is supplied to the regulation circuit board.

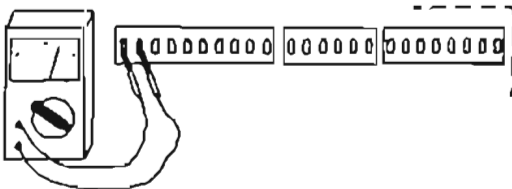

ref 3 Supply voltage should be indicated when power is supplied to the circulator.

ref 4 To check a winding, disconnect the winding from its circuit and measure the resistance in the winding:

Circulator	140 ohm
On-Off actuator	5 000 ohm
Fan	360 ohm
3-way valve	1 700 ohm



ref 5 To check the continuity of a cable, disconnect the cable from its circuit and measure the resistance when the two ends of the cable are connected. The resistance should be zero ohms with the tester set to the ohms function.

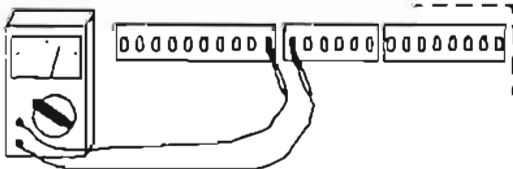

ref 6 Supply voltage should be present across these terminals when there is a demand for heat.



ref 7 Disconnect the terminals from the microswitch on the flow switch and measure the resistance. When the appliance is switched off the resistance should be infinity; when the appliance is switched on the resistance should go to zero ohms. To avoid electric shocks carefully insulate the electric terminals on the cable before this test.

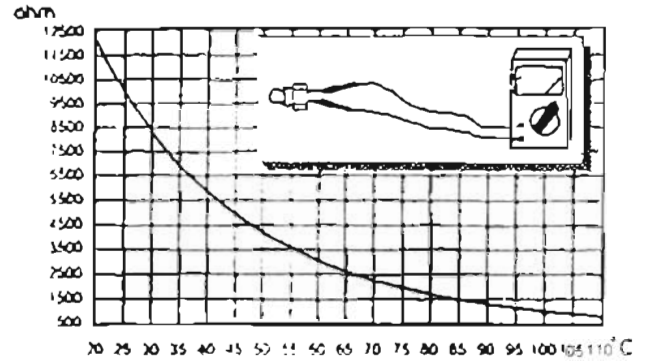

ref 8 The resistance of the NTC depends on its temperature (18 000 ohm at 10 °C) See the diagram for proper electric resistance at other temperatures.

ref 9 Disconnect the cable from the NTC to the regulation circuit board at both ends and measure the resistance between the two wires in the cable, which should be infinity.

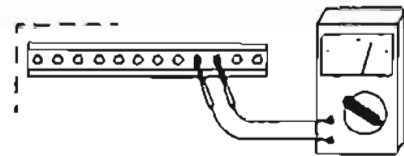

ref 10 220 VAC should be indicated when power is supplied to the fan.

ref 11 If the capacitor is faulty, the motor will heat up without rotating and the motor will only start when manually rotated in the proper direction.

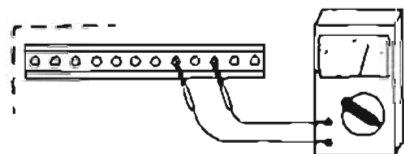

ref 12 0V should be indicated across these two points when the air switch closes correctly.

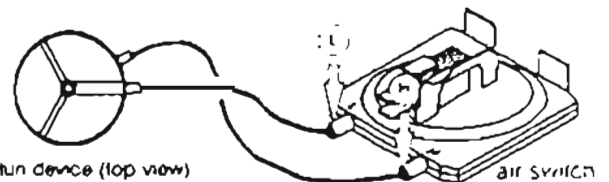

ref 13 The tubes between venturi device and air switch must be connected as shown.

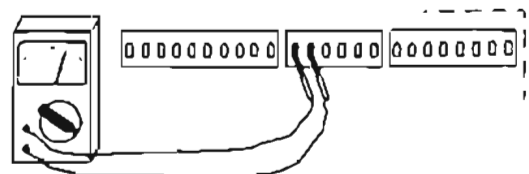

ref 14 Supply voltage should be indicated when power is supplied to the on-off actuator.

# Fault finding

## Operating malfunction on d.h.w. - heat switching

### Initial conditions:

- Appliance in the "d.h.w.-heating" mode.
- Closed thermostat or timer; ref. 1.
- Lever on the 3-way valve set to "automatic"; ref. 2.

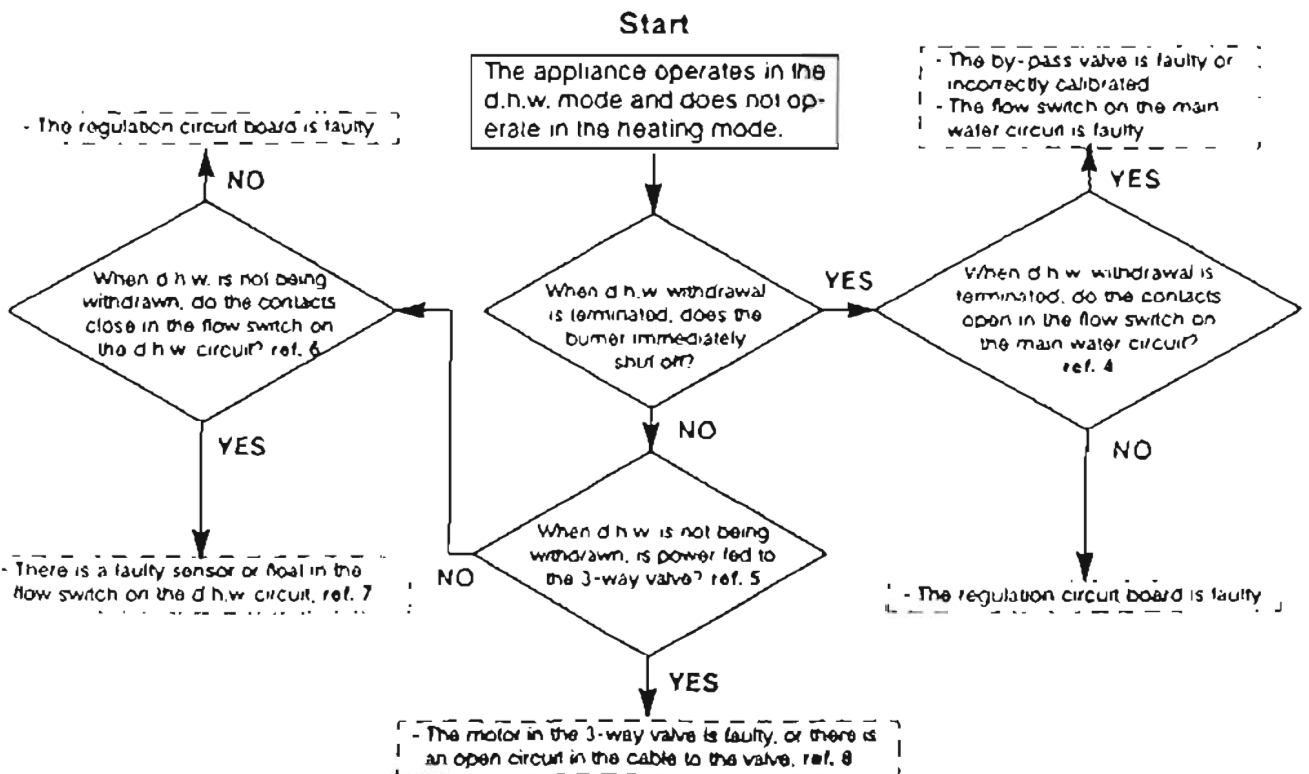
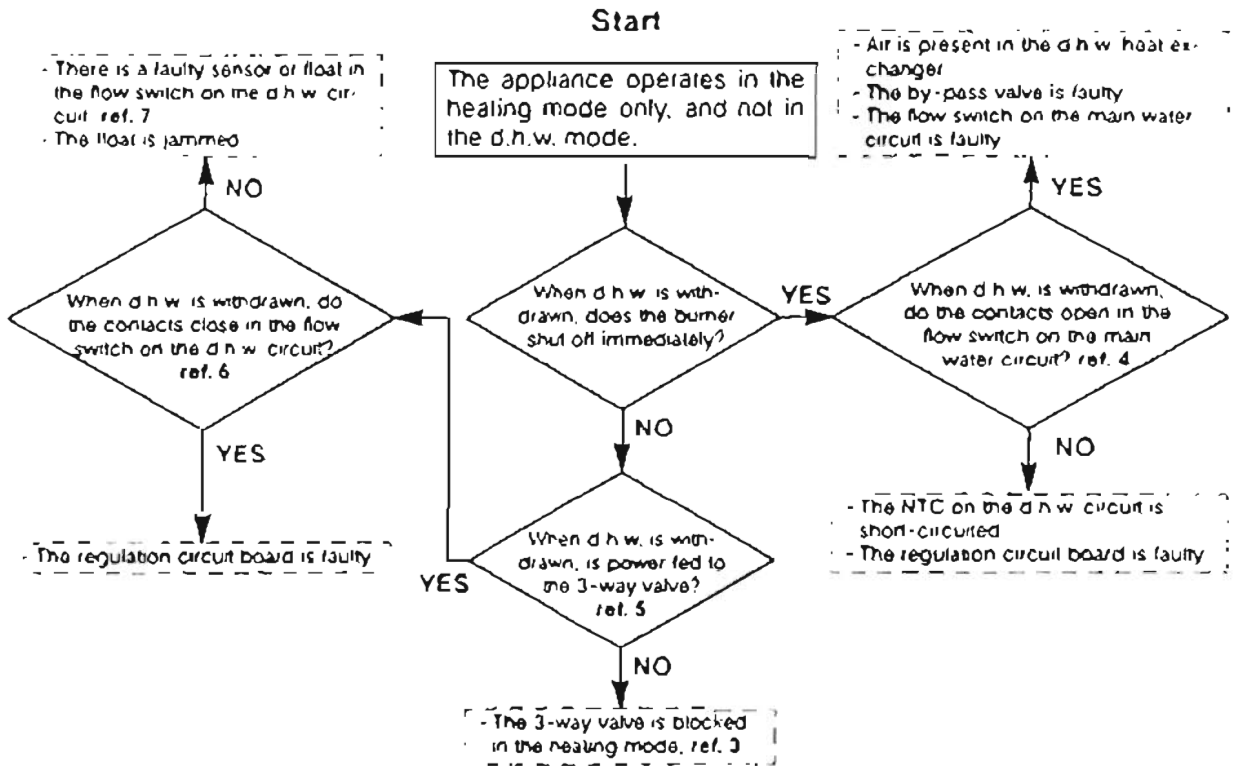

## Fault finding

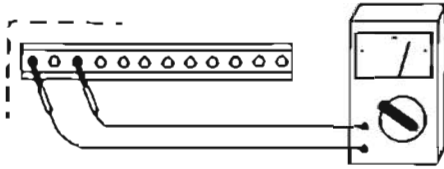

ref 1 Supply voltage should be indicated when the appliance is started with an open thermostat or timer.

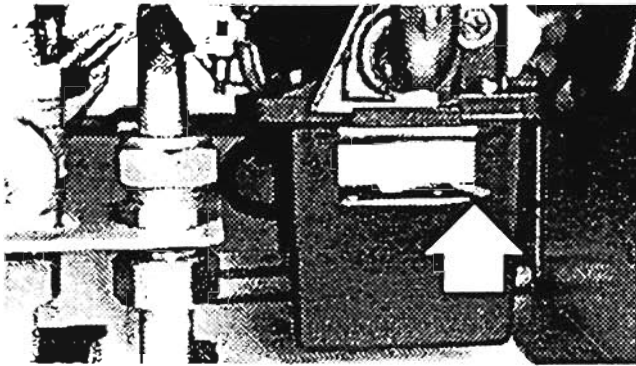

ref 2 The correct position of the lever on the 3-way valve during normal operation is shown in the picture (the lever should be positioned toward the right, as seen from the front of the appliance).

ref 3 If power is not being supplied to the 3-way valve, the lever must move freely over the first half of its travel from left to right. Also, the lever must meet resistance when moved over the remaining half of its travel from left to right. If the lever moves freely from left to right over its entire travel, the 3-way valve is jammed or faulty. Substitute the valve.

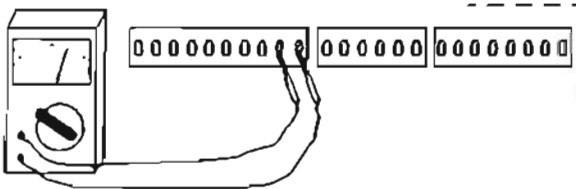

ref 4 When the contacts open in the flow switch on the main water circuit, the voltage across the points shown in the diagram should increase from 0 volts to supply voltage.

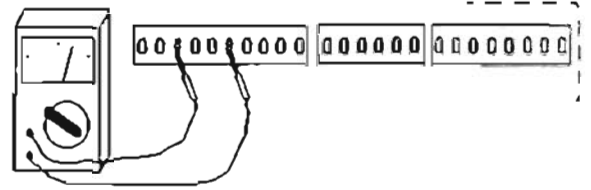

ref 5 Power is being supplied to the 3-way valve when supply voltage is measured across the points shown in the diagram.

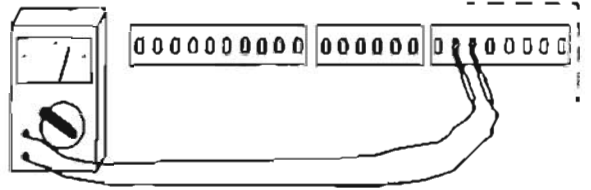

ref 6 If 12 VDC is measured across the points shown in the diagram, the contacts are open in the flow switch on the main water circuit. If 0 volts are measured, the contacts are closed in the flow switch on the main water circuit.

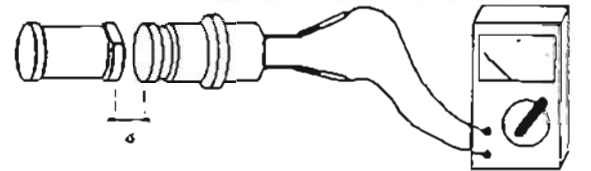

ref 7 The contact in the sensor on the flow switch is normally open (resistance at infinity). The contact must close (resistance zero) when the float is at distance  $d$  (approx. 4 mm).

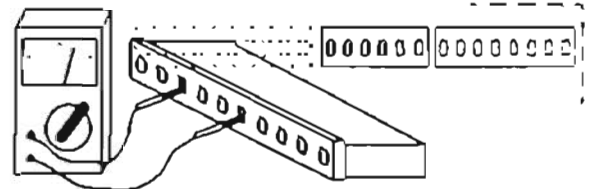

ref 8 At the regulation circuit board, disconnect the cable from the 3-way valve to the board. Measure the resistance across the cable, which should be 1700 ohms.

Troubleshooting the thermocouple circuit

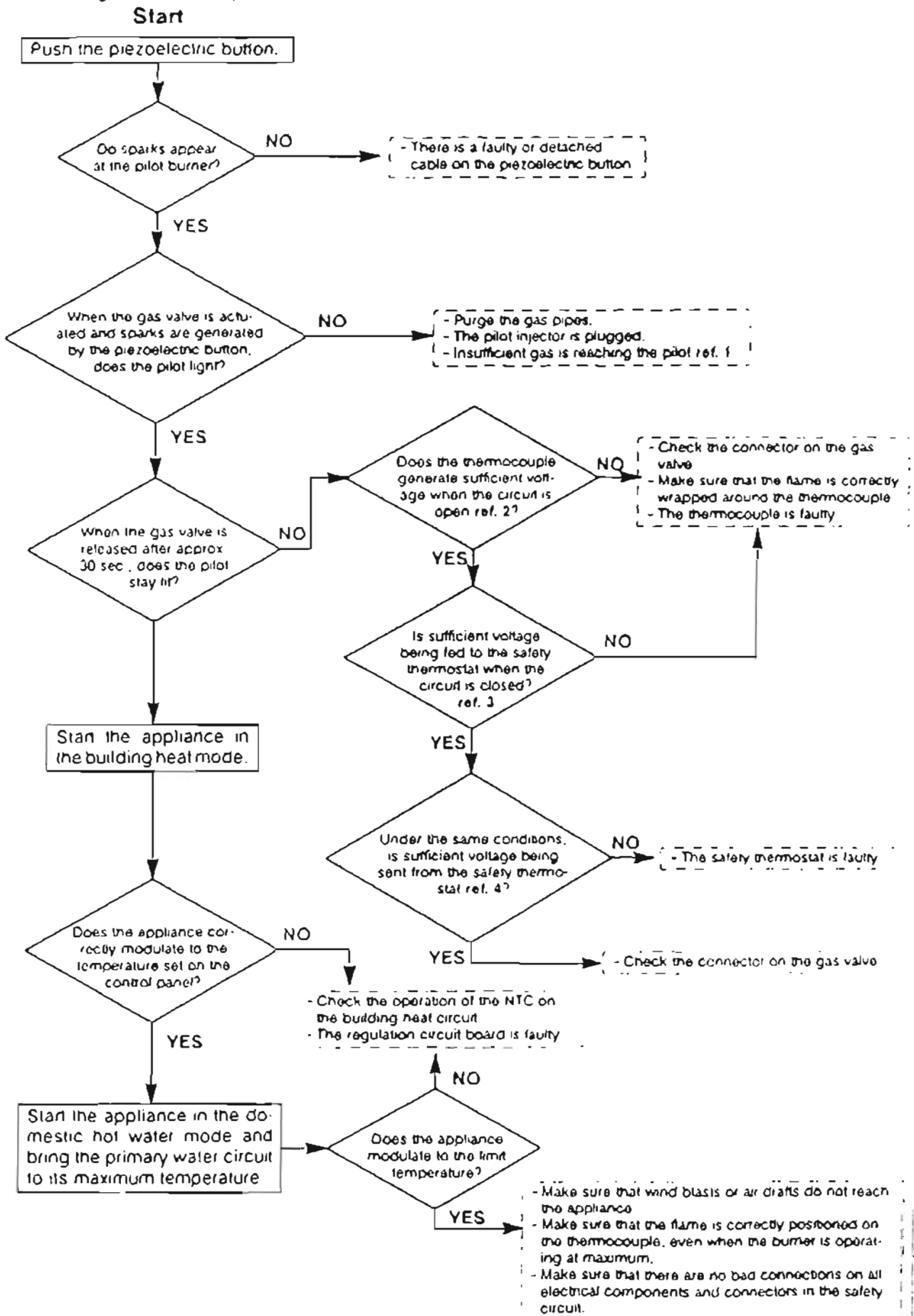

## Fault finding

- ref. 1 On the gas valve, the pilot flame is adjusted, as shown in the figure.  
Rotate the screw counter clockwise to increase the gas pressure.

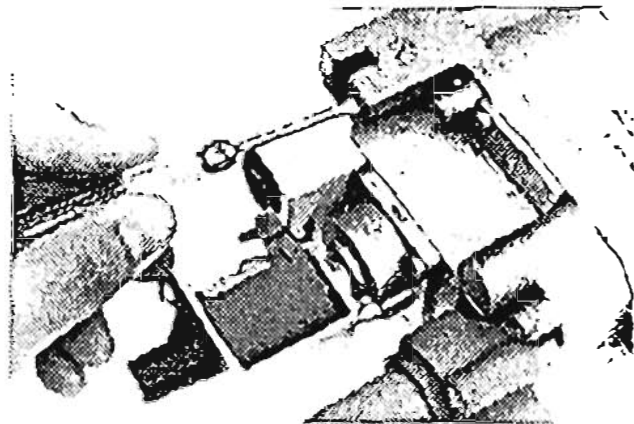

- ref. 2 The voltage measured in this configuration must be (at least) equal to or greater than 30 mV.

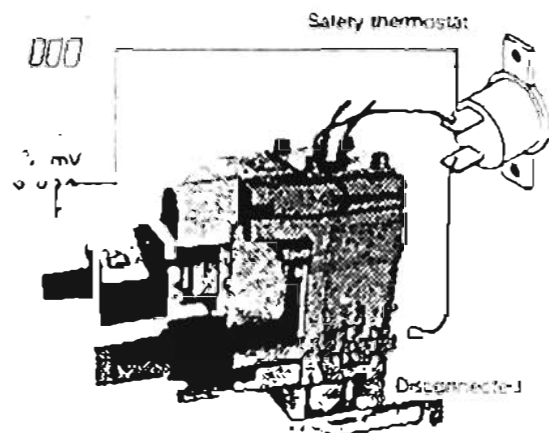

- ref. 3 The voltage measured in this configuration must be half of the voltage measured at ref. 2.

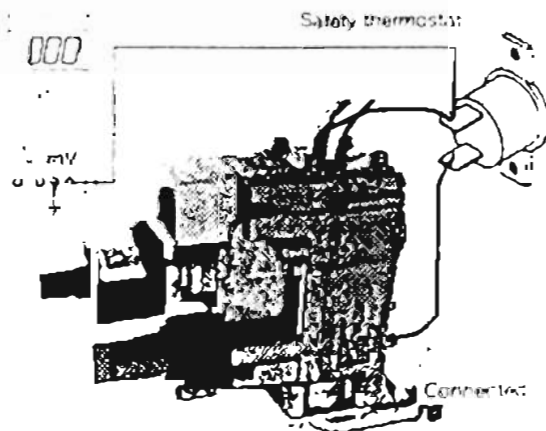

- ref. 4 The voltage measured at ref. 3 must not exceed the voltage measured in this configuration by more than 3 mV. In any case, this voltage must be at least 12 mV.

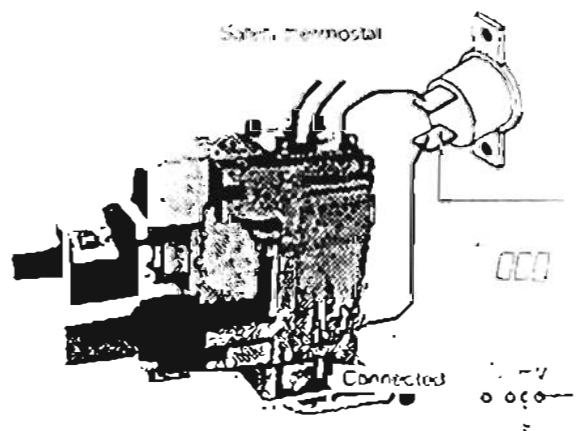

# 7 WIRING DIAGRAMS

## 7.1 General wiring layout

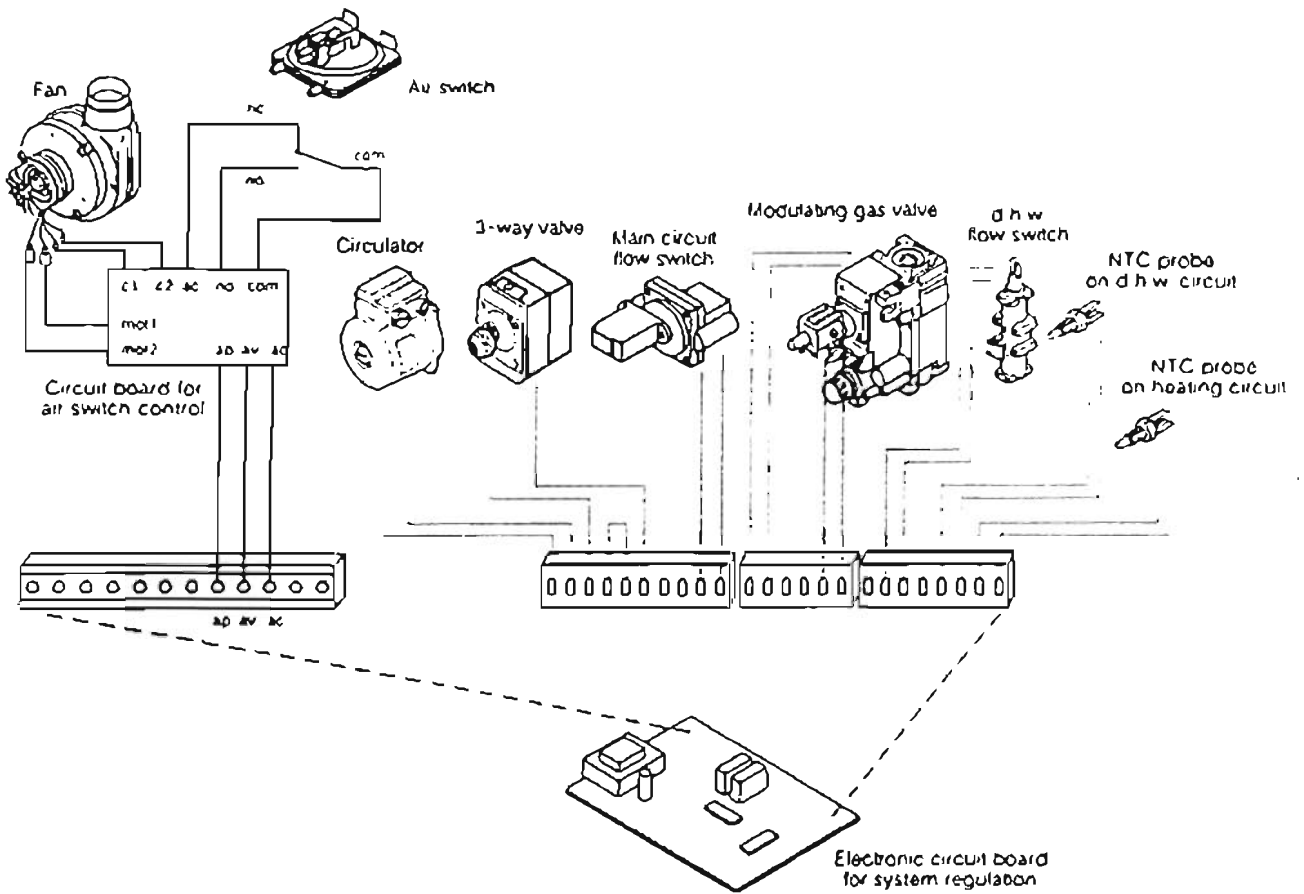

## 7.2 Electronic circuit board (power sect.)

