

GENUS 27 PLUS



Users Manual



*The code of practice for the installation,
commissioning & servicing of central heating systems*

Dear Customer,

Thank you for choosing an ARISTON boiler.

We guarantee that your boiler is a reliable and technically sound product.

This User's Manual provides detailed instructions and recommendations for proper installation, use and maintenance.

Remember to keep this manual in a safe place for future reference i.e. by the gas meter.

Your local MTS Servicing Centre is at your complete disposal for all requirements.

MTS (GB) Limited

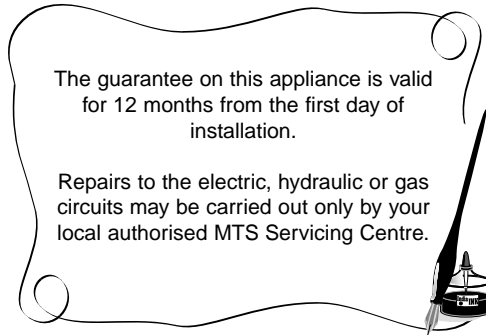

The guarantee on this appliance is valid for 12 months from the first day of installation.

Repairs to the electric, hydraulic or gas circuits may be carried out only by your local authorised MTS Servicing Centre.

Every attempt has been made to avoid errors of any kind in this User's Manual, the Management invites customers to inform of any inaccuracies which they may find. This will help to improve our service

IMPORTANT

Please read this manual carefully.

For additional information, please consult the "Installation and Servicing Instructions."

Please ensure manuals provided are kept with the appliance so that they can be used by the end-user, installer or our authorised engineer.

TABLE OF CONTENTS

1) GENERAL INFORMATION	page 3
2) OPERATING INSTRUCTIONS	page 4
3) TIME CLOCK	page 7
4) USEFUL INFORMATION AND TROUBLESHOOTING	page 10

1. GENERAL INFORMATION

MTS (GB) Limited support the *benchmark* initiative. Your installer will give you, and show you how to use, a logbook which will give you important information about your boiler, and heating system. Please have this logbook to hand whenever you contact a service engineer or us.

All CORGI Registered Installers carry a CORGI ID card, and have a registration number. Both should be recorded in your boiler Logbook. You can check your installer is CORGI registered by calling CORGI direct on :- (01256) 372300.

This is a combined appliance for the production of central heating (C.H.) and domestic hot water (D.H.W.). This appliance **must be used only** for the purpose for which it is designed. The manufacturer declines all liability for damage caused by improper or negligent use.

Do not allow children or inexperienced persons to use the appliance without supervision.

If you smell gas in the room, **do not turn on** light switches, use the telephone or any other object which might cause sparks.

Open doors and windows immediately to ventilate the room.

Shut the gas mains tap (on the gas meter) or the valve of the gas cylinder and call your Gas Supplier immediately.

If you are going away for a long period of time, remember to shut the mains gas tap or the gas cylinder valve.

Before any intervention within the boiler it is first necessary to cut off the electrical power supply by turning the external switch to "OFF".

This manual may be kept in the front panel of the boiler.

CONTROL PANEL

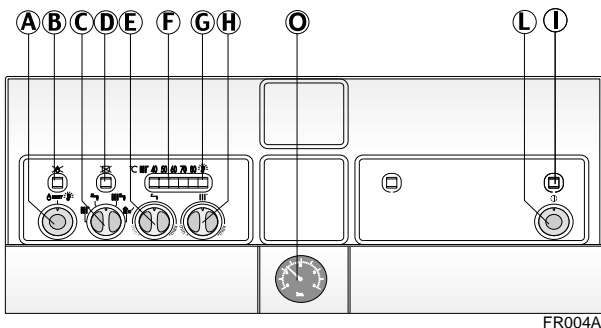

Legend

- A) Ignition Lockout Reset Button/Safety (Overheat)Thermostat Reset
- B) Ignition Lockout L.E.D.
- C) Selector Knob for Summer/Winter/Flue Analysis Modes
- D) Low System Water Level L.E.D.
- E) Temperature Adjustment Knob for Domestic Hot Water
- F) Heating System Thermometer
- G) Safety (Overheat)Thermostat Intervention L.E.D.
- H) Adjustment Knob for Heating Temperature
- I) On/Off L.E.D.
- L) On/Off Switch
- O) Heating System Pressure Gauge

2. OPERATING INSTRUCTIONS

CAUTION

Installation, start-up, adjustments and maintenance must be performed by a competent person only, in accordance with the current Gas Safety (Installation & Use) Regulations and the instructions provided. Improper installation may cause damage or injury to individuals, animals and personal property, for which the manufacturer will not be held liable.

To ensure efficient and safe operation it is recommended that the boiler is serviced annually by a competent person.

If it is known or suspected that a fault exists on the appliance, it must not be used until the fault has been corrected by a competent person.

HELPFUL SUGGESTIONS

To get the most out of your boiler, we have provided you with some useful advice on the proper use and maintenance:

- Periodically check the system pressure using the pressure gauge "O", make sure that the pressure at 1.5 bar (the blue part on the gauge) when the system is off and cool. The warning L.E.D. "D" will indicate if the pressure is below the minimum recommended value. Consult your installer for checking and refilling the system.
- The outer panels of the unit's case must only be cleaned with a damp cloth. Do not use abrasive cleaners. The Control panel can be wiped with either a damp or dry cloth. Spray polishes must not be used on the control panel surface or knobs. Care must be taken in preventing any liquid entering the appliance.
- If the water is exceptionally hard, install a water softener so that the efficiency of the unit remains the same over time, as this will consume less gas.
- To improve comfort and take full advantage of the heat produced by the boiler, it is recommended that an external thermostat be installed.
- If the boiler is not going to be used for an extended period of time, turn off the supply of electricity to the unit by pressing the On/Off switch "L".
- The green L.E.D. "I" will turn off. Then turn off the supply of gas to the unit itself.
- It is good practice to clean and service the appliance and central heating system every year.
- Call an Authorised Service Centre.

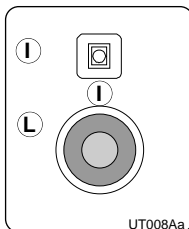
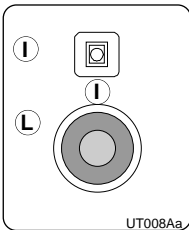
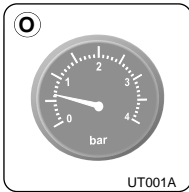

START-UP PROCEDURE LIGHTING

Before starting the unit, check the following:

- The water pressure on the pressure gauge "O";
- That the gas cock and the inlet for domestic water are open.

These models are equipped with electronic ignition which utilises contact ionisation.

To make the boiler operational, simply press the On/Off switch "L".

The green L.E.D. "I" will then turn on.

At this point the boiler is ready for use: a centralised electronic control unit will automatically light the main burner when needed. If the burner

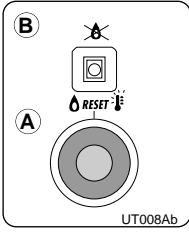

does not light within the pre-set safety time limit, the red “B” L.E.D. will light up. To reset the ignition system, the reset button “A” must be pressed. Should the system fail to light a second time, check to make sure that the gas cock is open. If the problem persists, contact one of our Authorised Service Centres for assistance.

WINTER AND SUMMER OPERATING MODES

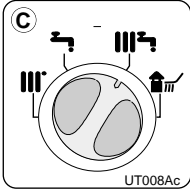

The boiler is fitted with a selector knob “C” which allows you to switch between winter < III' 2' > and summer < 2' > and also heating only < III' > operating modes and vice versa. When the knob is set to < III' 2' >, the boiler can serve the dual purpose of providing heat and/or hot water for domestic use.

The supply of hot water for domestic use always takes precedence over heating. When the knob is set to < 2' >, the boiler cuts out the heating system and only provides hot water for domestic use (when needed).

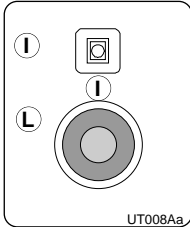

TURNING ON THE CENTRAL HEATING

Installation without a room thermostat :

- Turn on the power supply to the boiler by pressing the On/Off switch “L”; the green L.E.D. “I” will then turn on;
- Turn the “C” selector knob to < III' 2' > or < III' > (in this position no domestic hot water is produced);
- Regulate the temperature of the water in the boiler by turning the “H” knob. The temperature can vary between 42°C and about 82°C;
- Check the boiler temperature on the thermometer with the yellow L.E.D.s “F”. With this type of installation, the ambient temperature does not influence the operation of the boiler and the circulation pump always remains in operation.

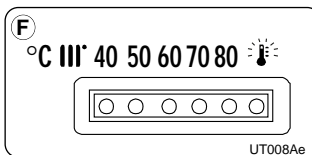
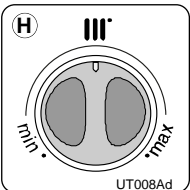
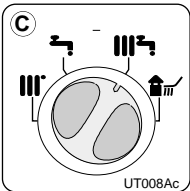

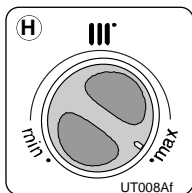

Installation with a room thermostat:

- Turn the “C” selector knob to < III' 2.3 >;
- Turn on the power supply to the boiler by pressing the On/Off switch “L”; the green L.E.D. will then turn on;
- Turn the thermostat knob “H” to the highest temperature setting.
- With this type of installation, the boiler is controlled by a room thermostat
- Therefore, it runs until the ambient temperature has reached the temperature setting on the thermostat. At that point, the main burner will turn off and the circulation pump will stop.

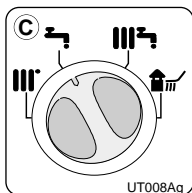

TURNING OFF THE CENTRAL HEATING

Installation without a room thermostat:

To turn off the heating, turn the “C” selector knob to < 2.3 >. The boiler will still provide hot water for domestic use.

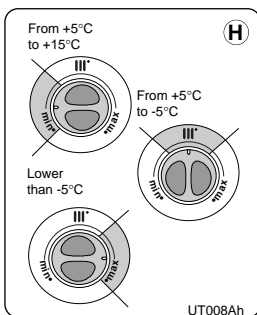

ADJUSTING THE HEATING TEMPERATURE

To economise on consumption while achieving the highest level of comfort, the temperature adjustment knob is designed with three different heating zones based on the temperature outside the home. Rotate the knob “H” as shown below.

PRODUCTION OF HOT WATER FOR DOMESTIC USE

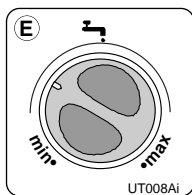

- Turn on the power to the boiler by pressing the On/Off switch “L”;
- Turn the “C” selector knob to < III' 2.3 > or < 2.3 > (in this position no central heating is produced);
- Turn the “E” knob to select the temperature for the hot water (between 40°C and about 70°C).

ADJUSTING THE TEMPERATURE OF WATER FOR DOMESTIC USE

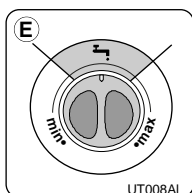

It is recommended that the temperature for the hot water should not be set to high temperatures and then mixed with cold water. Setting the thermostat to medium temperatures is preferable (see figure).

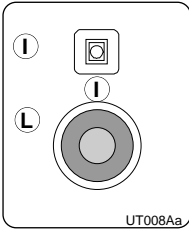

SHUTDOWN PROCEDURE

To turn off the main burner, simply press the On/Off switch “L”; the green L.E.D. “I” will also turn off.

As a precautionary measure, it is recommended that the gas cock located on the bottom of the boiler be turned off as well.

3. TIME CLOCK

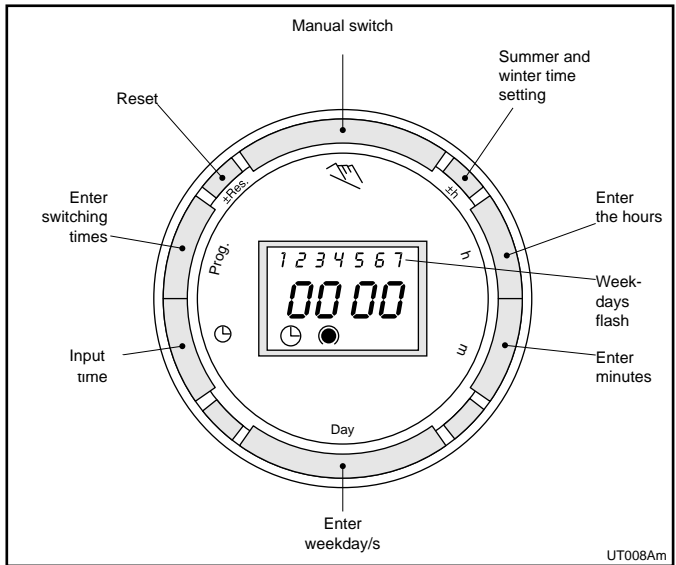

Operating the time switch

The step marked with the symbol “▶” are necessary to carry out a switching program.

Preparing for Operation

- ▶ Activate the “Res” switch (=RESET) to reset the time switch to its default setting (activate using a pencil or similar pointed instrument). Do this:

- every time you wish to “reset” the time switch
- to erase all switching times and the current time of day.

After approximately two seconds the following display appears:

▶ Enter current time and weekday

- Keep the “⌚” key pressed down
- During the summer time period press the +/- 1h key once.
- Enter the hour using the “h” key
- Enter the minutes using the “m” key
- Enter the day using the “Day” key
- 1 = “Monday”.....7 = Sunday
- Release the “⌚” key.

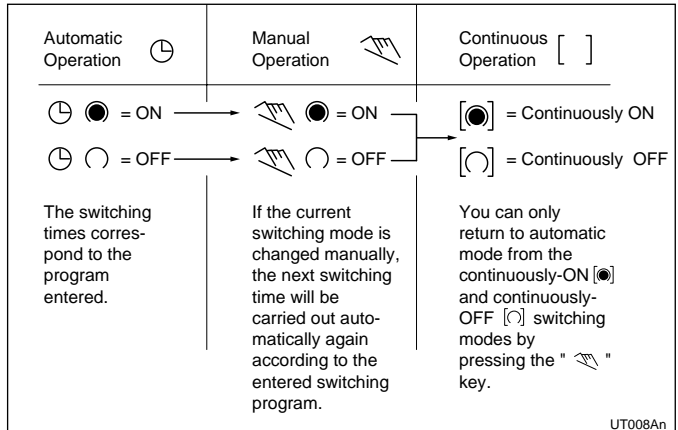



► Entering the switching times

You have 20 memory locations available. Each switching time takes up one memory location.

Keep pressing the "Prog" key until a free memory location is shown in the display "--:--".

Programme ON or OFF with the "" key:

"" = OFF; "" = ON

Enter the hour using "h"

Enter the minutes using "m"

If a switching command is to be carried out every day (1 2 3 4 5 6 7) then store using the "" key, otherwise select the day(s) it is to be carried out by using the "Day" key.

When the day selection is left blank, the programmed switching instruction operates at the same time every day

1 2 3 4 5 6 = Monday – Saturday



1 2 3 4 5 = Monday – Friday

6 7 = Saturday – Sunday

Selection of single days: 1 = Mon. 2 = Tues.

Save the switching time with the "" key.

The time switch enters the automatic operating mode and displays the current time of day.

Begin any further entry of a switching time with the "Prog" switch. If your entry is incomplete, the segments not yet selected will blink in the display. After programming is completed, and you return the time clock to the current time display with the "" key, the time clock will not activate any switching instruction required for the current time. You may need to manually select the desired switching state with the "" key. Thereafter, as the unit encounters further switching instructions in the memory in real time, it will correctly activate all subsequent switching instructions.

Manual Override Switch ""

With the "" you can change the current setting at any time. The switching program already entered is not altered.

Reading the programmed switching times

Pressing the "Prog" key displays the programmed switching times until the first free memory location appears in the display "-- : --".

If you now press the "Prog" key once again, the number of free memory locations will be displayed, e.g. "FR 18". If all memory locations are occupied, the display "FR 00" appears.

Changing the programmed switching times

Press the "Prog" key repeatedly until the switching time you want to change is displayed. You can now enter the new data. See point "Entering the switching times".

Notes on storing switching times:

If you end your entry of the switching times by pressing the "Prog" key, then the switching time you have entered will be stored and the next memory location displayed. Entry of further switching times is also carried out as described in point 4.3.

In addition, a complete switching command is stored **automatically** after around 90 seconds provided **no other** key is pressed. The time switch then enters the automatic operating mode and displays the current time again.

Deleting individual switching times

Press the "Prog" key repeatedly until the switching time you wish to delete is shown in the display. Then set to "--" using the "h" or "m" key and keep the "⏻" key pressed down for around 3 seconds. The switching time is now erased and the current time is displayed.

AM / PM time display

If you press the "+/-1h" and "h" keys at the same time, the time display switches into the AM/PM mode (mostly used in English-speaking countries).

Technical data

Connection	see unit imprint
Switching capacity	see unit imprint
Ambient temperature	-10°C to +55°C
Running reserve	5 h at + 20°C
Memory locations	20
Shortest switching time	1 min.
Programmable	every minute

4. USEFUL INFORMATION AND TROUBLESHOOTING

BOILER SHUTDOWN

The boiler unit is equipped with safety devices which intervene in certain situations to shutdown the boiler.

Some of these situations are signalled by the unit and can be corrected by the user.

SHUTDOWN DUE TO THE FAILURE OF THE BURNER TO LIGHT AUTOMATICALLY

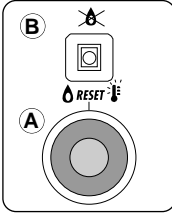

This anomaly is indicated by the red “B” L.E.D.

To reset the unit, press and then release the “A” button.

At this point, the electronic ignition system will attempt to light the burner again.

If lighting failure occurs repeatedly, it is recommended that you contact one of our Authorised Service Centres.

SHUTDOWN DUE TO OVERHEATING

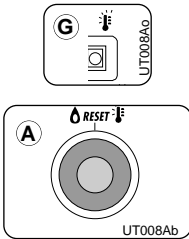

This anomaly is signalled by the red “G” L.E.D.

The boiler shuts off because the safety thermostat detected that the boiler temperature has reached the temperature limit.

To reset the unit, wait until the boiler has cooled and then press the “A” button.

If the safety thermostat shuts off the unit on a frequent basis, contact one of our Authorised Service Centres for assistance.

SHUTDOWN DUE TO INSUFFICIENT WATER CIRCULATION

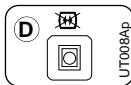
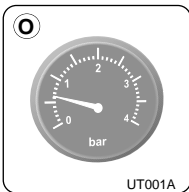

This anomaly is indicated by the red “D” L.E.D.

One of the possible causes of this shutdown situation could be the lack of water in the boiler or water circulation failure in the primary heating circuit.

Check the system pressure on the pressure gauge “O” and, if it is less than 0.5 bar, consult your installer for checking and refilling the system.

Then reset the unit by turning the boiler off and then back on with the On/Off button “L”.

If this situation persists, contact one of our Authorised Service Centres.

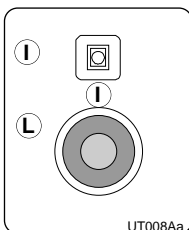

FLUE TEST FEATURE

(only for authorised personnel)

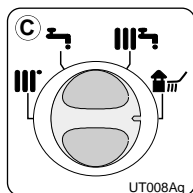

The “C” Summer/Winter/Flue Test selector knob can be set to < III > to bypass temperature adjustment on the heating circuit for the purpose of analysing the fumes produced by combustion.

To access this mode, open a water tap or taps so that the flow rate is no less than 8 litres per minute.

Then press the “C” selector knob in and turn it from < III > or < I > to the < II >.

WARNING!

The flue test feature eliminates the slow-light feature.

This mode must only be selected by a qualified service engineer.

Manufacturer: **Merloni TermoSanitari SpA - Italy**

Commercial subsidiary: **MTS (GB) LIMITED**

MTS Building
Hughenden Avenue
High Wycombe
Bucks HP13 5FT

Telephone: (01494) 755600

Fax: (01494) 459775

Internet: <http://www.mtsgb.ltd.uk>

E-mail: info@mtsgb.ltd.uk

Technical Service Hot Line: (01494) 539579