

## Instructions for Use

### Condensing Boilers/ Ultracom hxi

12hxi G.C. No. 41-019-01

15hxi G.C. No. 41-019-02

18hxi G.C. No. 41-019-03

24hxi G.C. No. 41-019-04

30hxi G.C. No. 41-019-05

38hxi G.C. No. 41-019-06

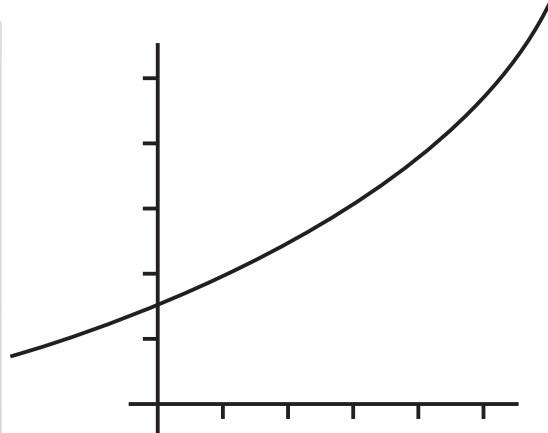

# TABLE OF CONTENTS

## READ CAREFULLY BEFORE USING

1	Read me.....	4
	1.1 Welcome.....	4
	1.2 Guarantee Pack.....	4
	1.3 Servicing.....	4
	1.4 Benchmark .....	5
	1.5 Quick Reference Guide .....	5
2	Introducing your appliance .....	6
	2.1 Appliance description .....	6
	2.2 Accessories .....	6
3	Product documentation .....	6
	3.1 Document storage .....	6
	3.2 Explanation of symbols.....	6
4	Safety .....	7
	4.1 What to do if you smell gas .....	7
	4.2 Safety recommendations.....	7
	4.3 Safety regulations.....	8
5	Guarantee Responsibility .....	9
	5.1 Detailed Guarantee .....	9
	5.2 Appliance Use / Manufacturer responsibility .....	9
6	Recycling.....	10
	6.1 Appliance.....	10
	6.2 Packaging.....	10
7	Clearances .....	10

## HOW TO USE YOUR APPLIANCE

8	Overview .....	11
	8.1 Display Description.....	11
	8.2 Switching On and Off.....	12
	8.3 User Controls.....	13
	8.4 Setting the 24 hour clock.....	14
	8.5 Setting the inbuilt programmer .....	15
	8.6 Advancing the timed central heating programmer.....	16
	8.7 Advancing the domestic hot water programmer.....	16

# TABLE OF CONTENTS

## ANY ASSISTANCE?

9	Fault Finding .....	16
	9.1 Electrical circuit interruption.....	16
	9.2 Appliance fails to light.....	17
10	Appliance Safety Devices .....	17
	10.1 Boiler Shutdown .....	17
	10.2 Protecting Against Frost .....	17
	10.3 Condensate Drain Blockage.....	18
	10.4 Safety Discharge Valve .....	18
11	Appliance Maintenance and Servicing .....	18
	11.1 Cleaning .....	18
	11.2 Regular Servicing .....	18
	11.3 Sealed Water Systems .....	19
	11.4 Spare Parts.....	19
12	Tips for Saving Energy.....	19
13	Contact your after-sales organisation .....	19

**READ CAREFULLY BEFORE USING**

**1 Read me**

**1.1 Welcome**

These instructions are an integral part of the boiler and must, to comply with the current issue of the Gas Safety (Installation and Use) Regulations, be left with the user.

Ensure that the installer has fully completed the Benchmark Checklist located on the inside back pages of the installation instructions supplied with the product and that you have signed it to say that you have received a full and clear explanation of its operation. The installer is legally required to complete a commissioning checklist as a means of complying with the appropriate Building Regulations (England and Wales).

All installations must be notified to Local Area Building Control either directly or through a Competent Persons Scheme. A Building Regulations Compliance Certificate will then be issued to the customer who should, on receipt, write the Notification Number on the Benchmark Checklist.

Read these instructions and follow them carefully for the safe and economical use of your boiler.



*Do not forget to read the chapters "Safety" and "Guarantee" where you will find important information for your safety.*

---

**1.2 Guarantee Pack**

The pack contains the letter of introduction and the guarantee. The extended guarantee is supplied loose and we recommend that you should read it.

Complete and return as soon as possible your guarantee registration card.

If your guarantee registration card is missing you can obtain a copy or record your registration by telephoning the Glow-worm Customer Service number 0800 073 2142.

**1.3 Servicing**

This product should be serviced regularly to optimise its safety, efficiency and performance. The service engineer should complete the relevant Service Record on the Benchmark Checklist after each service. The Benchmark Checklist may be required in the event of any warranty work and as supporting documentation relating to home improvements in the optional documents section of the Home Information Pack.

To ensure the continued efficient and safe operation of the boiler it is recommended that it is checked and serviced at regular intervals. The frequency of servicing will depend upon the site conditions and usage, but in general, once a year should be enough.

To obtain service, call your installer or Glow-worm's own service organisation using the telephone number on the inside front cover of this booklet.

### 1.4 Benchmark

Glow-worm is a licensed member of the Benchmark Scheme which aims to improve the standards of installation and commissioning of domestic heating and hot water systems in the UK and to encourage regular servicing to optimise safety, efficiency and performance.

Benchmark is managed and promoted by the Heating and Hotwater Industry Council.

- For more information visit [www.centralheating.co.uk](http://www.centralheating.co.uk)



### 1.5 Quick reference guide

We designed this Quick reference guide so that you can start using your appliance right away.

This Quick reference guide assumes that the appliance has been installed and commissioned by a competent person.

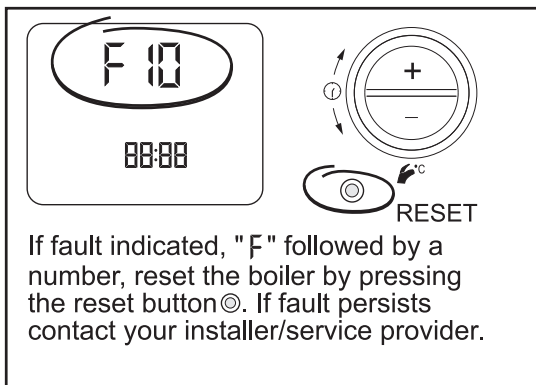
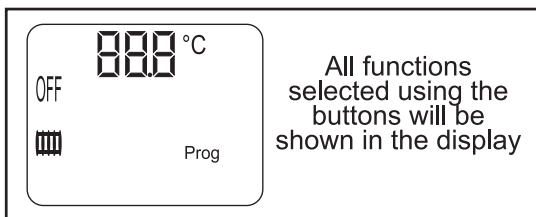
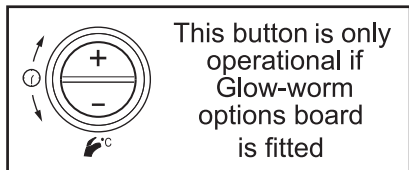
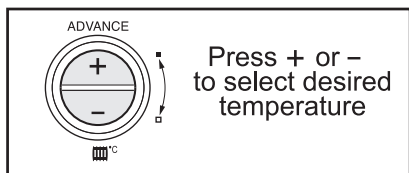

## 2 Introducing your appliance

### 2.1 Appliance description

The Ultracom hxi range of boilers are designed to provide central heating from a fully pumped open vented or sealed water system and domestic hot water using a fully indirect cylinder.

Once the controls are set, the boiler operates automatically.

Intelligent controls are available as accessories from Glow-worm.

Contact your Installer or Glow-worm sales for further information.

The Ultracom hxi boiler is an appliance that uses condensing technology, which recovers heat from the flue gases, this operating principle, consumes less energy and contributes to the reduction of your household CO<sub>2</sub> emissions.

This appliance is a room-sealed type equipped with a flue system for air supply and the removal of combustion products. This flue system offers the possibility to install the appliance in any room without the need for additional ventilation.

Installation and commissioning of the appliance should only be carried out by a competent person. They are responsible for the installation and the commissioning in accordance with standards in force.

You should also consult a competent person for maintenance and repair of the appliance as well as for any adjustment necessary.

### 2.2 Accessories

The Ultracom hxi is compatible with most makes of 230V programmable room thermostats.

For increased system compatibility and increased energy saving with intelligent control Glow-worm offer a range of controls dedicated to work using a unique communication system - eBus (low voltage).

For further details contact your installer.

## 3 Product documentation

### 3.1 Document storage

- Make sure that this manual is stored close to your appliance for future reference. Should you move home ensure that this manual is handed over to the new home owners.
- Read these instructions and follow them carefully for the safe and efficient use of your appliance.

No responsibility or liability can be accepted for damages caused by failure to follow the instructions in this manual.

### 3.2 Explanation of symbols



***DANGER: Risk of injuries.***

---



***ATTENTION: Risk of damage to the appliance or to its surroundings.***

---



***IMPORTANT INFORMATION***

---

## 4 Safety

### 4.1 What to do if you smell gas?

- isolate your gas supply at the gas emergency control valve.
- Eliminate all sources of ignition, i.e. smoking, blowlamps, hot air guns etc.
- do not operate electrical lights or switches, either on or off. Open all doors and windows, ventilate the area.
- open immediately windows and doors in order to ventilate the property.
- do not search for gas leaks with a naked flame.
- call your gas supplier's emergency phone number.
- alert other building occupants.

### 4.2 Safety recommendations

You must comply with the following recommendations and safety instructions:

- Never perform any maintenance or repair of the appliance yourself. Only competent persons are allowed to work on the appliance.
- Never tamper with safety devices.
- Do not attempt to modify the appliance or its immediate surroundings as this may affect on the safe use of the appliance.
- Under no circumstances must the user interfere with or adjust sealed parts.
- Do not allow children to operate the appliance.
- Do not obstruct the flue system

Certain home improvements may adversely affect the operation of your appliance – you should consult your installer for advice before carrying out any work.

- Do not expose the appliance to high humidity.
- Do not use or store explosive or inflammable materials (e.g. petrol, aerosols, solvents, chlorine based detergents, paint, glue etc.) in the same room as the appliance. Under certain conditions, these substances can prove to be corrosive.
- Do not touch the heated surfaces of the appliance, such as outlet duct, hydraulic connections, also after the appliance operation because, for a certain time, these surfaces may become hot. Any contact with them can cause burns.

This appliance contains metal parts (components) and care should be taken when handling and cleaning, with particular regard to edges.

- In the case of any water leak, immediately turn off the cold water supply to the appliance and have the leak repaired by your competent person.
- Do not store or place articles on the appliance.

### 4.3 Safety regulations

Servicing/maintenance should be carried out by a **competent person** approved at the time by the Health and Safety Executive, in accordance with the rules in force in the countries of destination.

If this boiler is installed in a rented property in the UK there is a duty of care imposed on the owner of the property by the current issue of the Gas Safety (Installation and Use) Regulations, Section 35.

#### **Gas Safety (Installation and Use) Regulations**

In your own interests and that of safety, it is the Law that ALL gas appliances have been installed by a competent person approved at the time by the Health and Safety Executive, in accordance with the current issue of these regulations.

#### **Gas Category**

This boiler is for use only on G20 natural gas but can be converted for use on G31 propane.

#### **Electrical Connection**

The boiler **MUST** be earthed.

The boiler **MUST** be connected to a permanent 230V ac, 50Hz supply, fused at 3A.

Connection of the whole electrical system of the boiler, including any heating controls, to the electrical supply must be through one common isolator.

The colours of three core flexible cable are, blue - neutral, brown - live, green and yellow - earth.

### Testing and Certification

This boiler is certificated to the current issue of EN 483 for performance and safety.

It is important that no alteration is made to the boiler unless approved, in writing, by Glow-worm.

Any alteration not approved by Glow-worm, could invalidate the certification, boiler warranty and may also infringe the current issue of the statutory requirements.

#### **CE Mark**

This boiler meets the requirements of Statutory Instrument, No.3083 of the Boiler (Efficiency Regulations, and therefore is deemed to meet the requirements of Directive 92/42/EEC on the efficiency requirements for new hot water boilers fire with liquid or gaseous fuels.

Type test for purposes of Regulation 5 certified by: Notified body 0087.

Product/production certified by: Notified body 0086.

The CE mark on this appliance shows compliance with:

- Directive 90/396/EEC on the approximation of the laws of the Member States relating to appliances burning gaseous fuels.

- Directive 73/23/EEC on the harmonisation of the Laws of the Member States relating to electrical equipment designed for use within certain voltage limits

- Directive 89/336/EEC on the approximation of the Laws of the Member States relating to electromagnetic compatibility.





*The CE mark shows that this appliance has been designed according to the safety techniques and rules in force. The compliance of this appliance with the relevant standards has been certified.*

## 5 Guarantee / Responsibility

### 5.1 Detailed guarantee

Thank you for installing a new Glow-worm appliance in your home.

Glow-worm appliances are manufactured to the very highest standard so we are pleased to offer our customers a Comprehensive Guarantee.

This product is guaranteed for 24 months from the date of installation or 30 months from the date of manufacture, whichever is the shorter, for parts and labour.

The second year of the parts guarantee, from the beginning of the 13th month onwards after installation or manufacture, is conditional upon the boiler having been serviced by a competent person approved at the time by the Health and Safety Executive, in accordance with the manufacturer's recommendations. We strongly recommend regular servicing of your gas appliance, but where the condition is not met, any chargeable spare parts or components issued within the applicable guarantee period still benefit from a 12 month warranty from the date of issue by the manufacturer.

### 5.2 Appliance use / manufacturer responsibility

Servicing/maintenance should be carried out by a competent person approved at the time by the Health and Safety Executive, in accordance with the rules in force in the countries of destination.

The guarantee is applicable on the condition that:

- The appliance is installed by a competent person in accordance with installation instructions.
- The appliance is used for normal domestic purposes and in accordance with the manufacturer's operating and maintenance instructions.
- The appliance is serviced, maintained, by a competent person.
- The repair or replacement of parts during the guarantee period does not have the effect of extending the period.

The manufacturer has no responsibility whatsoever for any damage resulting from:

- Any defects or damage resulting from incorrect or poor installation, inadequate servicing, or maladjustment of the gas or water used.
- Any defects in the system to which the appliance is connected.
- Any defects caused by inadequate frost protection.
- Any deterioration or maladjustment following changes in the nature or pressure of the gas or the water used, or a change in the characteristics of the electrical supply voltage.
- For further details, refer to your Terms and Conditions.



***This appliance is intended to be installed only within the designated countries displayed on the type plate.***

- It is the responsibility of parents, guardians and carers, that the appliance is protected away from persons under their care.

## 6 Recycling

This appliance contains many recyclable parts and should be disposed of according to the current WEEE regulations. The packaging should also be disposed of according to the current regulations.

### 6.1 Appliance

The appliance must be recycled in compliance with the WEEE (Waste Electrical and Electrical Equipment) directive which, in particular, requires:

- selective collection of waste electrical and electronic equipment,
- the systematic selective processing of certain components and substances deemed dangerous,
- reuse, recycling and energy recovery of collected WEEE's.



***This symbol indicates that this appliance must not be disposed of with household waste, that it should be selectively collected for energy recovery, reuse or recycling.***

- Take the appliance to an appropriate collection point for processing, energy recovery and recycling of waste Electronic and Electrical Equipment.



*By complying with this directive, you will contribute to the preservation of natural resources and the protection of human health.*

## 6.2 Packaging

The competent person who installed the appliance must:

- sort the waste so as to separate those which can be recycled (cardboard, plastics...) from those that cannot.
- dispose of the waste in compliance with regulations in force.

## 7 Clearances

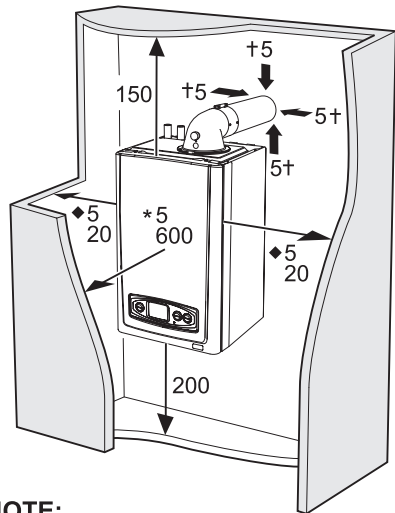

### NOTE:

\*A removable compartment door can be placed a minimum 5mm in front of the appliance. A clearance of 600mm is required from a fixed surface

- ◆ 5mm to a non-permanent surface  
20mm to a permanent surface.
- † 5mm clearance to combustible material.

**HOW TO USE YOUR APPLIANCE**

**8 Overview**

**8.1 Display Description**

The User Control panel consists of three toggle buttons, a reset button and display, which will indicate with symbols the status of the boiler

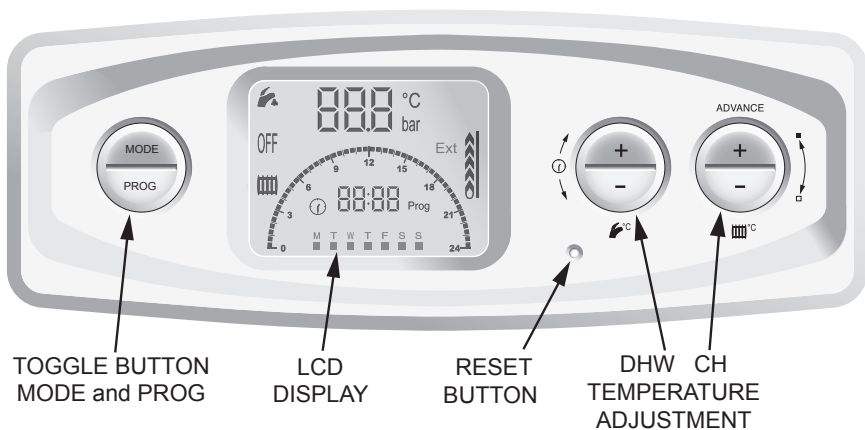

SYMBOLS DISPLAYED ON THE LCD AND DESCRIPTIONS			
	Central Heating Function	Prog	Programmer Adjustment Mode
	Domestic Hot Water Function	Ext	Glow-worm external control (Optional)
	Central Heating Timed Mode		Min burner display
	Appliance OFF		Max burner display
	Temperature		

## 8.2 Switching On and Off

### Switching on

- Remove the cover plate.

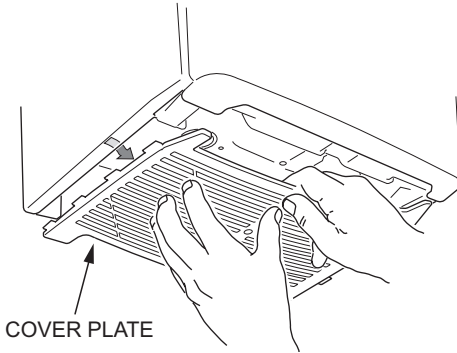

- Check that the gas service isolation valve on the appliance is open.

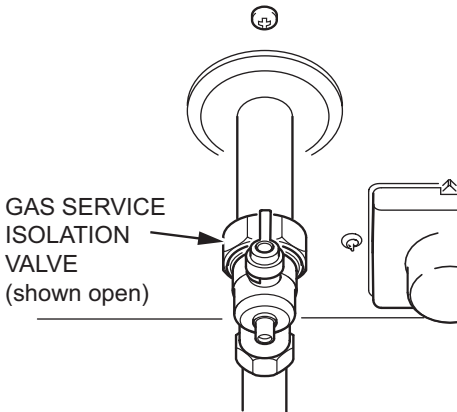

**Do not operate the boiler without water.**

- Make sure that:
  - The appliance has electrical power,
  - The gas service isolation valve is open.



**If you are in any doubt about the boiler being filled with water contact your installer or Glow-worm's own service organisation using the telephone number shown in the chapter "Contact your after-sales organisation".**

- Select your required function press "MODE" repeatedly to scroll through your options and select one of the following:-
  - Central heating. 
  - Boiler functions ALL switched off. OFF
  - Turn ON your external controls and select the room temperature required.
  - The boiler will operate automatically.
  - NOTE: The display will indicate the Heating system water temperature or a fault code (see section Fault Finding).
  - The control panel will flash and display all its digits. It will then return to the default display and depending on the selected operation and controls, display the temperature settings.

### Switching off

- press "MODE" repeatedly to scroll through your options and select OFF .

All the appliance functions will be switched off, except frost protection.



***If you intend to leave your property empty for a prolonged period, refer to the Appliance Safety Devices section.***

### 8.3 User Controls

#### Central Heating

The temperature is factory preset to the minimum 38°C, but can be adjusted to a maximum of 82°C as required, refer to steps 1 and 2.



Press the "+" or "-" once the current temperature will be displayed "flashing".

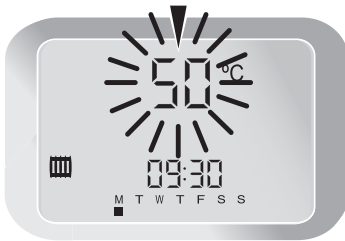

Press "+" or "-" to increase or decrease the temperature. The temperature setting will automatically save after 5 seconds.

## 8.4 Setting the 24 hour Clock

To set the clock, follow steps 1 to 3.

### STEP 1



Press and hold "PROG" 5 secs.  
the "hours" symbol will flash.

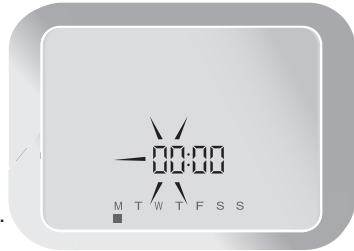

### STEP 2

Press the "+" or the "-"  
to set the hour.

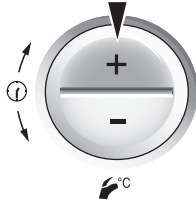

### STEP 3



Press "PROG" to confirm.

The process will automatically scroll to minutes,  
then days, set as previously described.

## 8.5 Setting the inbuilt programmer

To alter the times to suit your requirements, follow "Steps" 1 to 4.

**STEP 1** Press the "PROG" button once to view Mondays factory default central heating running times.

**STEP 2** Press + or - to move the flashing cursor to the desired time.

**STEP 3** Press "+" to add a time segment or "-" to remove a time segment.

**STEP 4 - COPY FUNCTION.** When validating the timed intervals you can hold the "PROG" button for 5 seconds and the times will be duplicated onto the next day, hold the button continually and the times will be copied to all days.

**STEP 4** Press "PROG" to validate the time intervals. The days will automatically change, repeat the process or refer to the "Copy Function". After the 7th. day the "Domestic Hot Water" time intervals will be displayed, follow the same process steps 1 to 4.

**STEP 4** Press "PROG" to validate the time intervals. The days will automatically change, repeat the process or refer to the "Copy Function". After the 7th. day the process will exit to show the boiler status.

Flashing cursor.

"Running Time" Indicated by solid squares. Square represents 30 minutes.

### Timed Central Heating

Factory preset timed intervals are:-

Monday to Friday - ON 6.00 - OFF 8.00.  
ON 16.00 - OFF 23.00.

Saturday & Sunday - ON 8.00 OFF 23.00.

### Timed Domestic Hot Water

Factory preset times for preheat are:-

Monday to Sunday - ON 6.00 - OFF 24.00.



*The inbuilt programmer for Central Heating and Domestic Hot Water, can only be used if Glow-worm controls are installed.*

## 8.6 Advancing the timed central heating programmer ON /OFF times

This function will only work when the appliance is in timed operating mode, "Clock symbol".

Refer to display description in section 8.1.

The activated/deactivated segments will flash for 5 seconds.

Press + and hold for 5 seconds your appliance will operate until the next OFF period, or you can cancel by pressing + for 5 seconds.

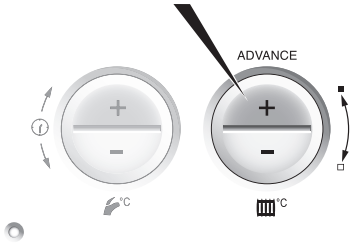

*Advanced functions only available if the in-built programmer is enabled.*

## 8.7 Advancing the Domestic Hot Water programmer ON /OFF times

This function will only work when the appliance is in timed operating mode, "Clock symbol".

Refer to display description in section 8.1.

The main screen is then displayed again.



*There is no visual indication that this feature has been activated once the segments have stopped flashing.*

## ANY ASSISTANCE?

### 9 Fault Finding

#### 9.1 Electrical circuit interruption

The boiler will not work without an

Press + and hold for 5 seconds your appliance will operate until the next OFF period, or you can cancel by pressing + for 5 seconds.

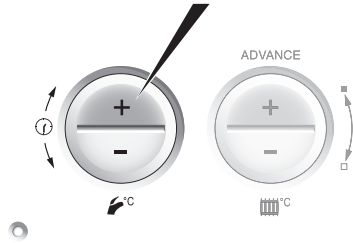

electrical supply and normal operation of the boiler should resume when the electrical supply is restored.

If the boiler does not resume normal operation, check the external controls.

It may be necessary to restart your appliance.

- To restart the boiler, press the reset button, see chapter "How to use your appliance ► Overview".



## 9.2 Appliance fails to light

The LCD will display a flashing 'F' and code number,

CODE	DESCRIPTION	POSSIBLE CAUSES
F1	Boiler has attempted to light 5 times and failed on all occasions	Press the reset button. If the fault persists, contact your Installation/Service company or Glow-worm
F5	Overheat	Boiler has overheated - allow to cool then press reset button

- To restart the boiler, press the reset button, see chapter "How to use your appliance ► Overview".

If any fault persists, and your appliance still does not work, leave it switched off and contact your competent person.



*Like all condensing boilers it will produce a plume of condensation from the flue terminal in cool weather. This is due to the high efficiency and hence low flue gas temperature of the boiler. It is normal and not a fault indication.*

## 10 Appliance safety devices

### 10.1 Boiler Shutdown

The boiler software is designed to recognise the potential for an overheat lockout and will shutdown before this happens.

- To restart the boiler, press the reset button, see chapter "How to use your appliance ► Overview".

If the boiler fails to resume normal operation and all external controls are calling for heat, then call your Installation/Service company or Glow-worm service.

### 10.2 Protecting against frost

#### Appliance Protection

In case of the risk of frost:

- Make sure that the electrical and gas supply to the appliance is turned on.
- For an absence of several days, you can leave the appliance to run normally.

The appliance has a built in frost protection device that protects the boiler from freezing. With the gas and electric supplies ON and irrespective of any room thermostat setting, the frost protection device will operate the pump when the temperature of the boiler water falls below 8°C. A timer is used so that the temperature can be checked periodically. After 10 minutes the pump will be stopped if the temperature is higher than 10°C or has already reached 35°C. The burner will activate if the boiler temperature does not reach 10°C after 30 minutes or at any time if the temperature drops to 5°C. The burner will switch off when the temperature reaches 35°C.

The appliance always has frost protection active when the power and gas supply are on.

## System Protection

The boiler alone cannot ensure that the installation is protected against frost.

**NOTE:** Any other exposed areas of the system should be protected by a separate frost thermostat.

In case of prolonged absence, where power to the dwelling and the boiler is switched off, contact your Installation/ Servicing company or Glow-worm Service to have the installation drained or to have the heating circuit protected by adding an anti-freeze specially designed for heating systems.



**CAUTION: Your domestic water circuit (hot and cold) is not protected by the boiler.**

---

## 10.3 Condensate Drain Blockage

As a safety feature the boiler will stop working if the condensate drain becomes blocked. During freezing conditions this may be due to the forming of ice in the condensate drain external to the house.

- Release an ice blockage by the use of warm cloths on the pipe.

The boiler should then restart.

- Contact your Installation/Servicing company or Glow-worm service if the fault persists.

## 10.4 Safety Discharge Valve

The safety discharge valve and discharge pipe is fitted to the boiler.

- If there is any discharge from the pipe, switch off the boiler electrical supply, then call your Installation/Servicing company or Glow-worm service.

## 11 Appliance maintenance and servicing

### 11.1 Cleaning

---



**Before cleaning turn the appliance off.**

---

The appliance casing can be cleaned using a mild liquid detergent with a damp cloth, then a dry cloth to polish.



**Do not use any form of abrasive or solvent cleaner as you may damage the paintwork.**

---

### 11.2 Regular servicing

Regular servicing of the appliance is important to the prolonged, safe and efficient use of your appliance.



**Incorrect or inadequate servicing can severely affect the safety of the appliance and can lead to injury.**

---

We recommend that your appliance is serviced every year.

- Only use a competent person.

The service engineer should complete the relevant Service Record on the Benchmark Checklist after each service. The Benchmark Checklist may be required in the event of any warranty work and as supporting documentation relating to home improvements in the optional documents section of the Home Information Pack.

To obtain service, call your installer or Glow-worm's own service organisation using the telephone number on the inside front cover of this booklet.

### 11.3 Sealed Water Systems

The draining, refilling and pressurising **MUST** be carried out by a **competent person** approved at the time by the Health and Safety Executive.

- Contact Glow-worm's own service organisation using the telephone number below.

Tel: 01773 828100

### 11.4 Spare Parts

In order to guarantee the safe and prolonged life of the product, insist that only the manufacturer's genuine spare parts are used.

- Do not use reconditioned or copy parts that have not been clearly authorised by Glow-worm.
- If replacement parts are required contact Glow-worm's own service organisation for advice using the telephone number below.

Tel: 01773 828100

or for approved stockist, visit [www.glow-worm.co.uk](http://www.glow-worm.co.uk).

Quote the name and model of the boiler.

The name and model badge is on the front case.

- If in doubt seek advice from the local gas company or Glow-worm's own service organisation using the telephone number below.

Tel: 01773 828100

## 12 Tips for saving energy

Your installer will be able to give energy saving advice about your system and its controls.

For energy saving advice you can contact the Energy Savings Trust for advice or visit [www.energysavingtrust.org.uk](http://www.energysavingtrust.org.uk) who offer simple effective advice about saving energy.

Regular servicing of your boiler will help maintain its efficiency - servicing once a year is recommended

Turn your thermostat down. Reducing your room temperature by 1°C could cut your heating bills by up to 10 percent. Set your heating and hot water at the time controller to come on only when required rather than all the time.

## 13 Contact your after-sales organisation

### *Customer service call*

Tel: 01773 828100

### *Technical helpline*

Tel: 01773 828300

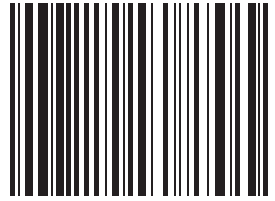

0020127403

Subject to engineering changes

0020127403 - 01/11



**GLOW-WORM**

Nottingham Road,  
Belper, Derbyshire.  
DE56 1JT

Because of our constant endeavour for  
improvement, details may vary slightly  
from those shown in these instructions.

**Glow•worm**

[www.glow-worm.co.uk](http://www.glow-worm.co.uk)