

User Guide

Condensing System Boiler

Promax System

12 - 15 - 18 - 24 - 32

Please keep these instructions in a safe place.
If you move house, please hand them over to the next occupier.

Natural Gas

Potterton Promax 12 System ErP

G.C.N° 41 592 42

Potterton Promax 15 System ErP

G.C.N° 41 592 43

Potterton Promax 18 System ErP

G.C.N° 41 592 44

Potterton Promax 24 System ErP

G.C.N° 41 592 45

Potterton Promax 32 System ErP

G.C.N° 41 592 46

Contents

Section	Page
1.0 Quick Reference Guide	3
2.0 Troubleshooting	4
3.0 Repressurising System	6
4.0 Clearances	7
5.0 Care of the Boiler	8
6.0 Legislation	9
7.0 Warranty & Service	10
8.0 ErP Information	12
9.0 Emergency	15
10.0 Disposal	15

The Benchmark Scheme

Baxi Heating UK Ltd is a licensed member of the Benchmark Scheme which aims to improve the standards of installation and commissioning of domestic heating and hot water systems in the UK and to encourage regular servicing to optimise safety, efficiency and performance.

Benchmark is managed and promoted by the Heating and Hotwater Industry Council. For more information visit www.centralheating.co.uk

© Baxi Heating UK Ltd 2016 All rights reserved. No part of this publication may be reproduced or transmitted in any form or by any means, or stored in any retrieval system of any nature (including in any database), in each case whether electronic, mechanical, recording or otherwise, without the prior written permission of the copyright owner, except for permitted fair dealing under Copyrights, Designs and Patents Act 1988.

Applications for the copyright owner's permission to reproduce or make other use of any part of this publication should be made, giving details of the proposed use, to the following address:

The Company Secretary, Baxi Heating UK Ltd,
Brooks House, Coventry Road, Warwick. CV34 4LL

Full acknowledgement of author and source must be given.

WARNING: Any person who does any unauthorised act in relation to a copyright work may be liable to criminal prosecution and civil claims for damages.

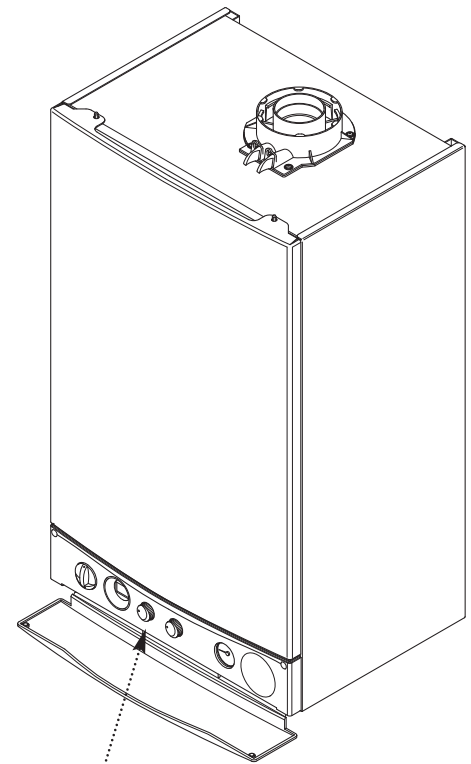

Boiler Controls - see opposite page
for Operating Quick Reference Guide



ISO 9001
FM 00866

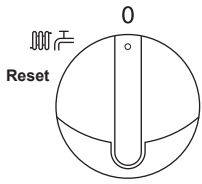

ON/OFF/Reset Selector Switch

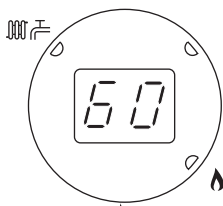

Display

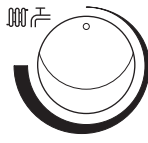

Central Heating Temperature Control

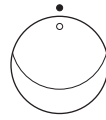

Calibration Control



System Pressure Gauge

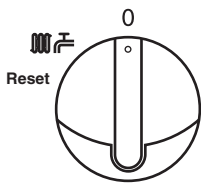
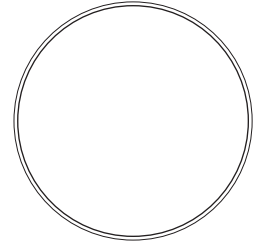

OFF Position
The boiler will not operate.

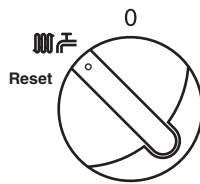

Central Heating & Hot Water
Both Heating & Hot Water will operate.

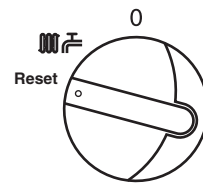

Reset
Hold for approx 5 seconds and release.

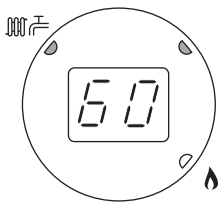

Display



Central Heating Indicator - The indicator will illuminate when the boiler is in the central heating mode.



Burner On Indicator - The indicator will illuminate when the burner has fired and is heating your central heating or domestic hot water.

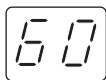

Boiler Output Temperature - In either the central heating or domestic hot water position the display will illuminate showing the current boiler temperature in degrees centigrade.

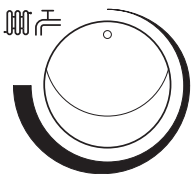

Central Heating Temperature Control

Turn the knob clockwise to increase or anticlockwise to decrease the temperature. Range 25 - 80° C.

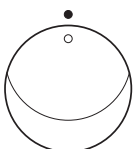

Calibration Control

This control is for use only by the installer or service engineer.



Central Heating System Pressure - The normal operating water pressure is between 1 and 2.0 bar. If the pressure exceeds 3 bar the safety pressure valve will operate and a fault is indicated. Contact your Installer.

Boiler not working

2.0 Troubleshooting

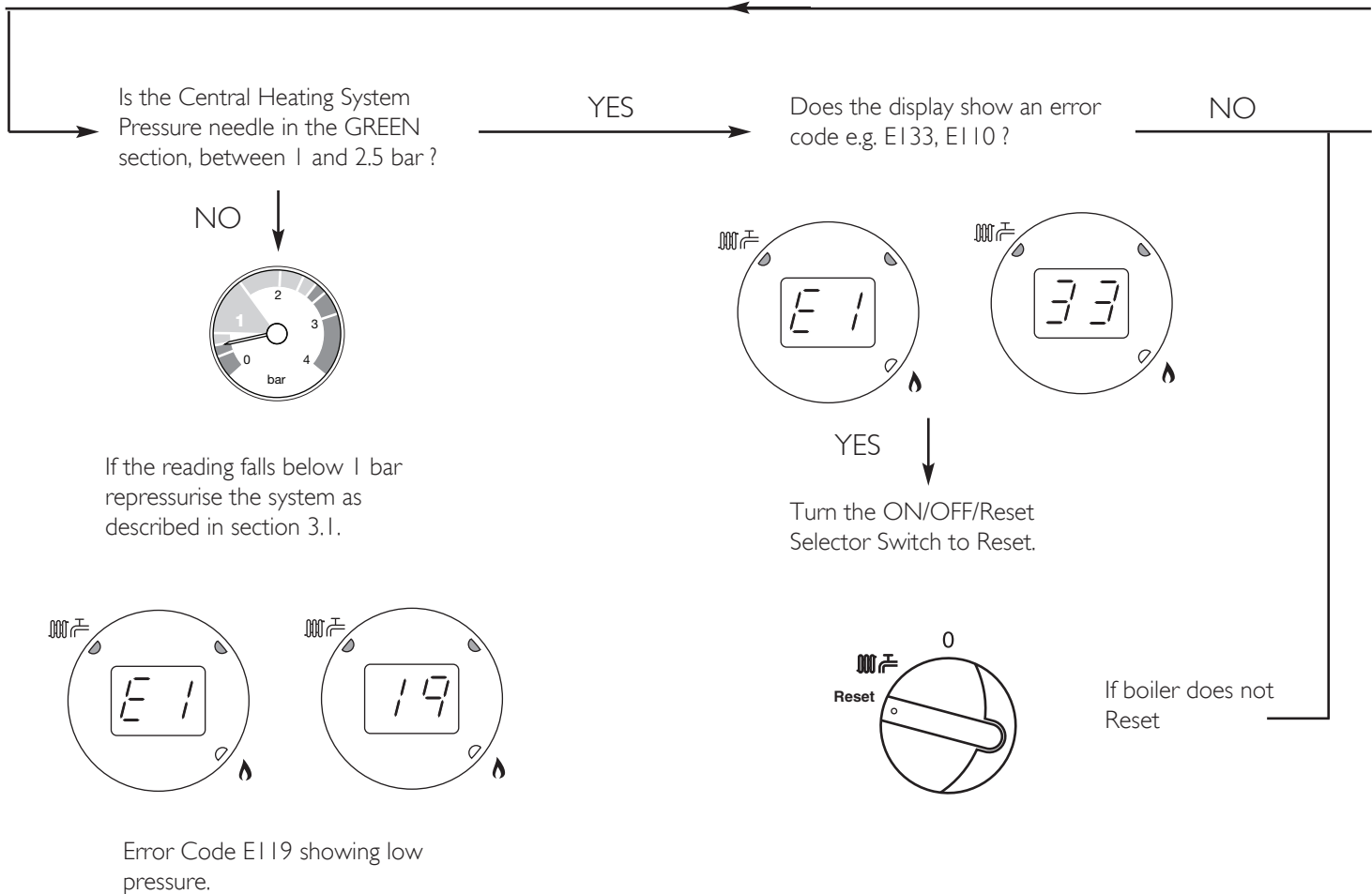
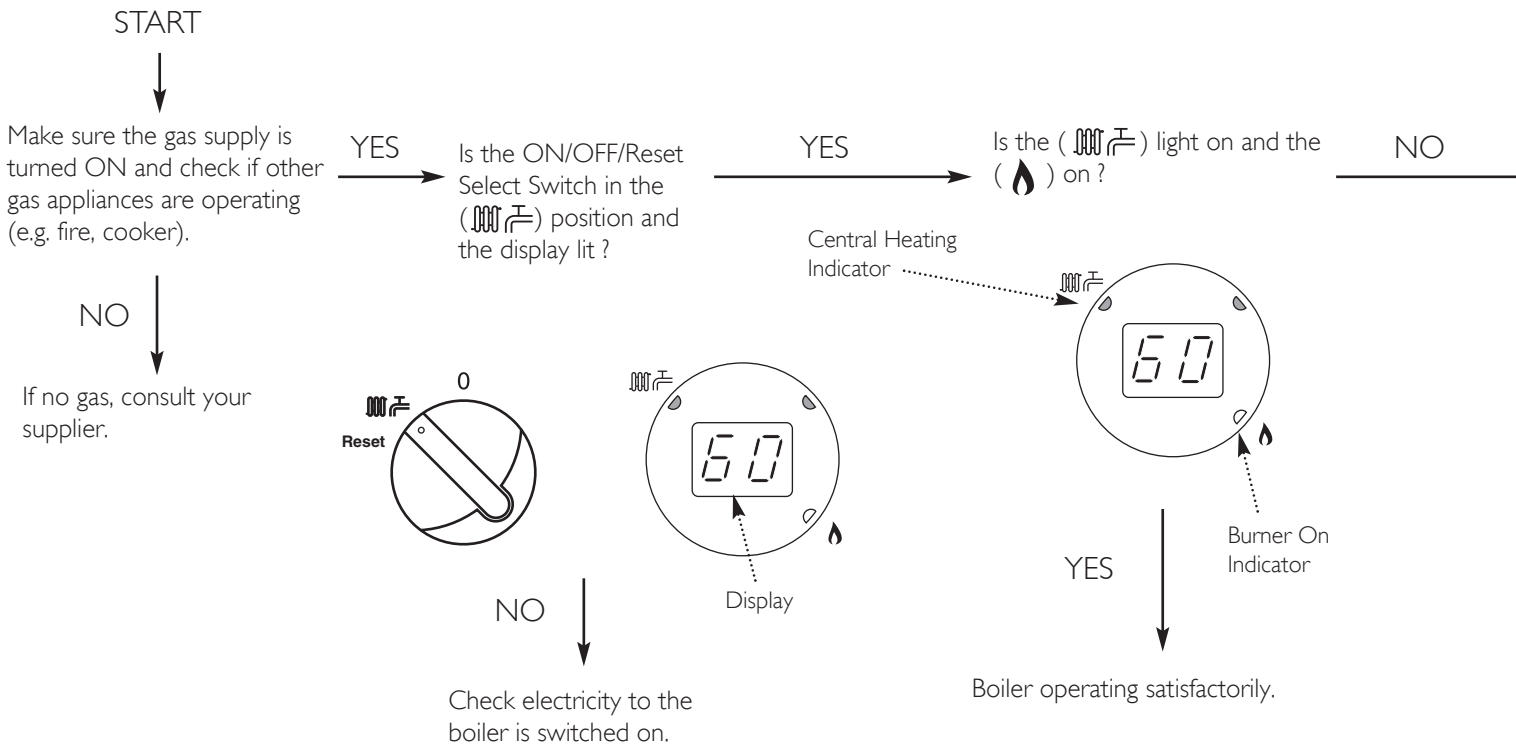

Is the Timer ON and calling for heat ?

YES

Is the Room Thermostat (if fitted) set high enough ?

YES

Typical examples of external timer

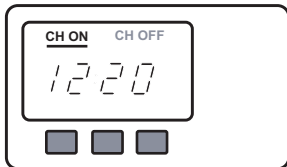
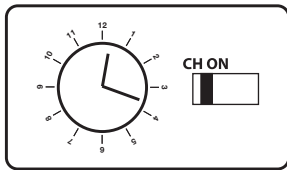

NO

Ensure timer is set for Central Heating ON (see any instructions supplied with timer).

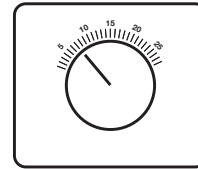

NO

Turn Room Thermostat to maximum setting (typical example shown).

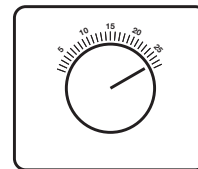

CONTACT YOUR INSTALLER OR SERVICE ENGINEER.

If you don't know what you need to do to get the boiler to light, or need help with the system and controls, contact your installer as soon as possible.

3.0 Repressurising the System

3.1 Central Heating System Pressure

1. The water pressure in the central heating system is indicated by the pressure gauge.

2. With the system cold and the boiler not operating the pressure should be at least 0.5 bar. During operation the pressure should not exceed 2.5 bar, and will normally be between 1.0 and 1.5 (Fig. 1).

3. A pressure of 3 or greater indicates a fault. The safety pressure relief valve will operate, at a pressure of 3 (Fig. 3). **It is important that your Installer or Service Engineer is contacted as soon as possible.**

4. The minimum pressure for correct operation is 0.5. If the pressure falls below 0.5, this may indicate a leak on the central heating system (Fig. 2). Error Code E119 will be shown on the display.

3.2 To Re-Pressurise the System

1. A filling device (the filling loop) will be fitted on the system. If you are unsure of its position, or cannot identify it, consult the installer who fitted the boiler.

2. The filling loop consists of two taps and a separate metal braided hose with connection fittings. The two taps should be fitted with blanking caps.

3. Only when repressurising should the hose be connected between the two taps. Remove any blanking caps from the taps and ensure that the nuts on the hose are tightened onto the taps.

4. Fully open one of the taps first, and then while watching the pressure gauge, carefully open the second tap.

5. Once the needle on the gauge is above the 0.5 mark both taps can be closed.

6. Disconnect the metal braided hose from the taps (a small amount of water may be present) and remove it. Keep the hose in a safe place for future use. Refit the blanking caps.

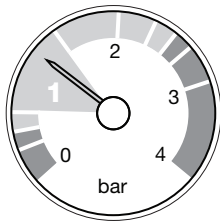

Fig. 1

Normal Pressure

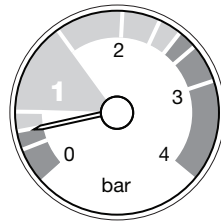

Fig. 2

Requires
Repressurising

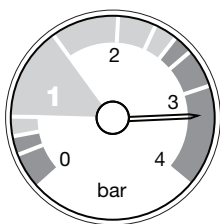

Fig. 3

Fault

4.0 Clearances

4.1 For your Safety

NOTE: Only qualified persons are authorised to assemble, install and maintain the installation.

1. This appliance must have been installed in accordance with the manufacturer's instructions and the regulations in force.

2. Any modification that may interfere with the normal operation of the appliance without express written permission from the manufacturer or his agent could invalidate the appliance warranty. In GB this could also infringe the Gas Safety (Installation and Use) Regulations.

GB - Heating Industry definition meaning England, Scotland, Wales, Northern Ireland, Isle of Man and the Channel Isles

3. Your boiler must not be operated without the casing correctly fitted.

4. Do not interfere with any sealed components on this boiler.

5. Take note of any warning labels on your boiler.

6. Your boiler should have the following minimum clearances for Safety and Maintenance (Fig. 4):-

Top	- 175mm
Bottom	- 150mm*
Left side	- 5mm
Right Side	- 5mm
Front	- 5mm (In Operation)
	- 450mm (For Servicing)

*This is the MINIMUM recommended dimension. Greater clearance than this will aid installation and maintenance.

7. If your boiler is installed in a compartment, do not use it for storage purposes. Do not obstruct any purpose provided ventilation openings.

8. Flammable materials must not be stored in close proximity to your boiler.

9. Avoid skin contact when your boiler is in operation, as some surfaces may get hot e.g. pipework.

10. Ensure that the flue terminal, outside the house, does not become damaged or obstructed, particularly by foliage.

11. It is important that the condensate drain system is not blocked, modified or damaged in any way as this would affect the operation of your boiler. Your installer should have insulated any exposed pipework.

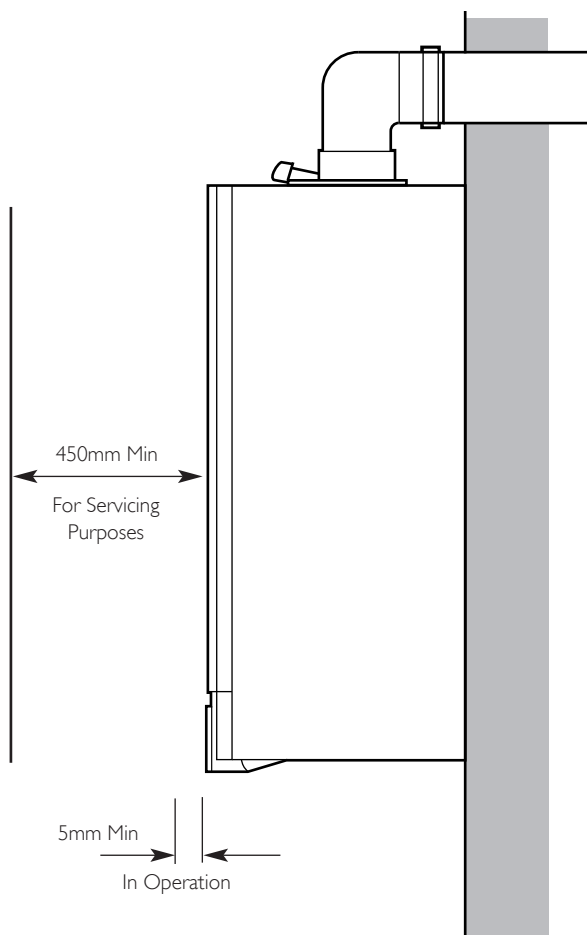
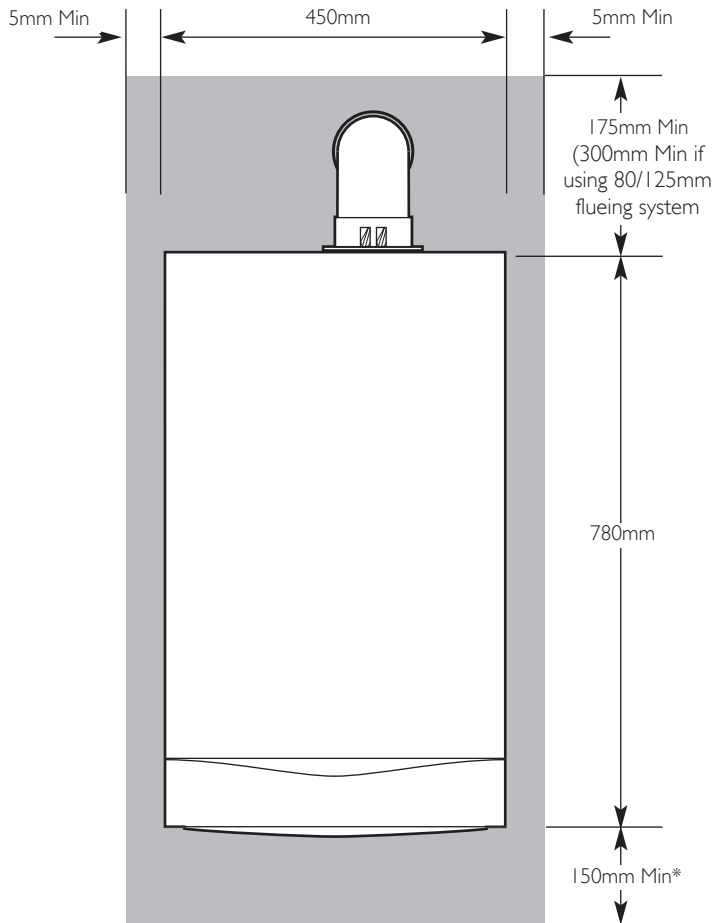



Fig. 4

5.0 Care of the Boiler

5.1 Cleaning the Outer case

The painted panels should be wiped with a damp cloth and then dried completely. **DO NOT USE ABRASIVE CLEANING AGENTS.**

5.2 Protection & Precaution

1. The boiler incorporates an integral frost protection feature that will operate when the selector switch is in the () position. If the boiler temperature falls below 5° C, then the boiler will operate until the water temperature has been raised.
2. If a system frost thermostat has been fitted (your installer will be able to advise you), then to operate correctly and protect your system, the gas and electricity must be left on and the appliance set in the central heating mode.
3. The boiler incorporates an integral pump protection feature which continually monitors the time since the pump last operated. To prevent seizure, the pump will operate for approximately 1 minute if it has not run in the last 24 hours.

5.3 Fault Indication

1. If a fault occurs on the boiler an error code may be shown on the facia display (Fig. 5).
2. The codes are either two or three digit, preceded by the letter 'E'. For example, code E133 will be displayed by 'E1' alternating with '33'. E50 is shown as 'E' then '50'.
3. E20, E28, E125 & E160 indicate faulty components. You should make a note of the displayed error code and contact your installer or service engineer. E28 may also indicate a blocked flue or condensate drain.
4. If E110 or E130 is displayed overheat of the primary water or flue system has occurred. Turn the selector switch to the reset position and hold for at least 5 seconds. If the boiler does not relight, or the code is displayed regularly contact your installer or service engineer.
5. E119 is displayed when the primary water pressure is less than 0,5 bar. After repressurising the system the boiler should operate. Your installer will be able to advise you about the method of repressurising. See page 6 for further details.
6. E133 indicates that the gas supply has been interrupted, ignition has failed or the flame has not been detected. Ensure that the gas supply has not been turned off, and turn the selector switch to the reset position and hold for at least 5 seconds. If the boiler does not relight, or the code is displayed regularly contact your installer or service engineer.

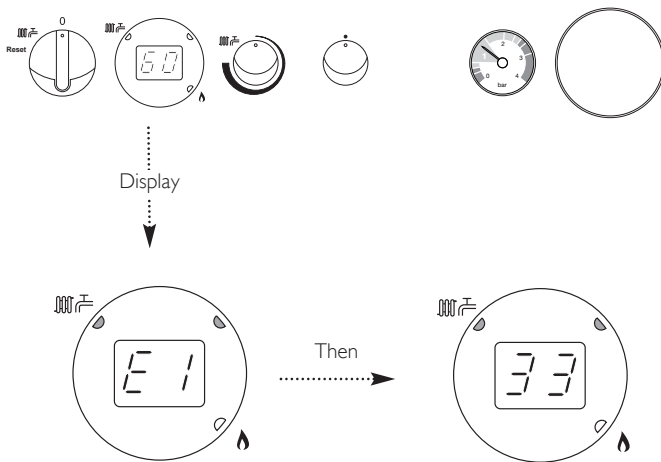

Fig. 5

Table of Error Codes

E20	Central Heating NTC Fault
E28	Flue NTC Fault, Air Pressure Switch Fault, Blocked Flue, Blocked Condensate or Wiring Fault
E110	Safety Thermostat Operated
E119	Water Pressure Switch Not Operated
E125	Circulation Fault (Primary Circuit)
E130	Flue NTC Operated
E133	Interruption Of Gas Supply or Flame Failure
E160	Fan or Fan Wiring Fault

6.0 Legislation

Warning

This boiler can be used by children aged 8 years and above and by persons with reduced physical, sensory or mental capabilities or lack of experience and knowledge when they have been given supervision or instruction concerning the safe use of the device and understand the resulting risks. Children must not be allowed to play with the appliance. Cleaning and user maintenance must not be carried out by children without supervision.

6.1 Installation, Commissioning, Service & Repair

1. This appliance must be installed in accordance with the manufacturer's instructions and the regulations in force. Read the instructions fully before installing or using the appliance.
2. In GB, this must be carried out by a competent person as stated in the Gas Safety (Installation & Use) Regulations.
3. **Definition of competence:** A person who works for a Gas Safe registered company and holding current certificates in the relevant ACS modules, is deemed competent.
4. In IE (Eire), this must be carried out by a competent person as stated in I.S. 813 "Domestic Gas Installations".

All Gas Safe registered engineers carry an ID card with their licence number and a photograph. You can check your engineer is registered by telephoning 0800 408 5500 or online at www.gassaferegister.co.uk

The boiler meets the requirements of Statutory Instrument "The Boiler (Efficiency) Regulations 1993 No 3083" and is deemed to meet the requirements of Directive 92/42/EEC on the energy efficiency requirements for new hot water boilers fired with liquid or gaseous fuels:-

Type test for purpose of Regulation 5 certified by:
Notified Body 0085.

Product/Production certified by:
Notified Bodies 0086.

For GB/IE only.

6.2 Benchmark Commissioning Checklist

1. Please ensure that the installer has fully completed the Benchmark Checklist on the inside back pages of the installation instructions supplied with the product and that you have signed it to say that you have received a full and clear explanation of its operation. The installer is legally required to complete a commissioning checklist as a means of complying with the appropriate Building Regulations (England and Wales).
2. All installations must be notified to Local Area Building Control either directly or through a Competent Persons Scheme. A Building Regulations Compliance Certificate will then be issued to the customer who should, on receipt, write the Notification Number on the Benchmark Checklist.
3. This product should be serviced regularly to optimise its safety, efficiency and performance. The service engineer should complete the relevant Service Record on the Benchmark Checklist after each service.
4. The Benchmark Checklist may be required in the event of any warranty work.

7.0 Warranty & Service

7.1 General

To make sure your boiler warranty is activated and maintained, it is essential that the:

1. Benchmark checklist is completed by your installer
2. Warranty is registered within 30 days
3. Boiler has an annual service

Please note that failure to adhere to terms and conditions will make your warranty invalid.

7.2 Standard Warranty Terms and Conditions

Warranty Registration, Service & Repair

For full terms and conditions, visit www.baxi.co.uk/terms.

Benchmark Checklist

The Benchmark Checklist will be completed by your installer and records that the boiler has been installed and commissioned correctly. It can be found at the back of the installation and service manual and should be kept in a safe place for the life of the boiler. We will check that the Benchmark Checklist has been completed on an in-warranty visit.

Ways to register your warranty

If your boiler is eligible for an extended warranty, your installer may register the product on your behalf and provide you with the relevant documentation. Please check with your installer.

Should this not be the case, you can register your warranty online at www.baxi.co.uk/registration

To activate a **standard two year warranty**, please use one of the following methods:

- Freephone 0800 013 7989 or
 - Return the enclosed registration card
-

7.0 Warranty & Service

Annual Service

A service must be completed every 12 months from the date of installation to maintain your warranty.

This service must be completed by one of the following:

- A Gas Safe registered installer/engineer
- Baxi Customer Support; call us 0344 871 1545

Please make sure that your engineer has logged the service information at the back of the installation and service manual. You will be asked for your service history on any in-warranty repair visit.

If you experience a problem with your boiler

For any in or out of warranty repair, Baxi Customer Support is on hand to help you. Call our award-winning team to arrange for one of our nationwide team of Gas Safe registered engineers to visit.

If your product is in warranty, everything is free of charge, subject to our warranty terms and conditions. If it is out of warranty, we can still help and offer a range of options you can choose from to suit your needs.

Contact Baxi Customer Support 0344 871 1545

Opening hours

Monday - Friday, 8.00am - 6.00pm

Weekends and Bank Holidays, 8.30am - 2.00pm

Please note calls may be recorded for training and monitoring purposes.

When contacting Baxi Customer Support, please have the following information to hand:

- Boiler serial number. This can be found on the appliance.
- Proof of purchase if you do not have the boiler serial number.

Please note that for in-warranty repairs, our engineers will ask to see your service history record, completed Benchmark Checklist and details of your installer. These can all be found in the installation and user manual.

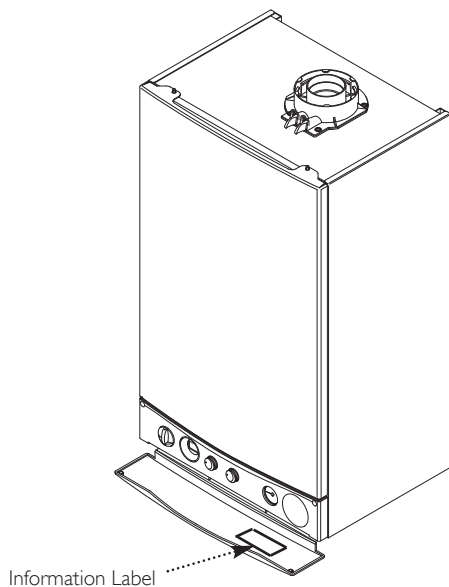

Product fiche for boiler space heaters

Potterton Promax System ErP		12	15	18	24	32
Seasonal space heating energy efficiency class		A	A	A	A	A
Rated heat output (<i>Prated or Psup</i>)	kW	12	15	18	24	32
Seasonal space heating energy efficiency	%	91	91	91	92	92
Annual energy consumption	kWh	10901	13391	16087	21478	28522
	GJ	39	48	58	77	103
Sound power level L_{WA} indoors	dB	55	52	53	58	54



See

For specific precautions about assembling, installing and maintaining, consult the relevant section as detailed on the Contents page.

8.2 Package Fiche - Boilers

Package fiche for boilers indicating the space heating energy efficiency of the package

Seasonal space heating energy efficiency of boiler

①
 %

Temperature control

from fiche of temperature control

Class I = 1%, Class II = 2%, Class III = 1.5%,
 Class IV = 2%, Class V = 3%, Class VI = 4%,
 Class VII = 3.5%, Class VIII = 5%

②
 + %

Supplementary boiler

from fiche of boiler

Seasonal space heating energy efficiency (in %)

③
 $(\text{input} - \text{'I'}) \times 0.1 = \pm \text{input} \%$

Solar contribution

from fiche of solar device

Collector size (in m²)

Tank volume (in m³)

Collector efficiency (in %)

Tank rating ⁽¹⁾
 A* = 0.95, A = 0.91,
 B = 0.86, C = 0.83,
 D - G = 0.81

$(\text{'III'} \times \text{input} + \text{'IV'} \times \text{input}) \times 0.9 \times (\text{input} / 100) \times \text{input} = + \text{input} \%$

(1) If tank rating is above A, use 0.95

Supplementary heat pump

from fiche of heat pump

Seasonal space heating energy efficiency (in %)

⑤
 $(\text{input} - \text{'I'}) \times \text{'II'} = + \text{input} \%$

Solar contribution AND Supplementary heat pump

select smaller value

$0.5 \times \text{④} \text{ OR } 0.5 \times \text{⑤} = - \text{⑥} \%$

Seasonal space heating energy efficiency of package

⑦
 %

Seasonal space heating energy efficiency class of package

<input type="checkbox"/>	<input type="checkbox"/>	<input type="checkbox"/>	<input type="checkbox"/>	<input type="checkbox"/>	<input type="checkbox"/>	<input type="checkbox"/>	<input type="checkbox"/>	<input type="checkbox"/>	<input type="checkbox"/>
G	F	E	D	C	B	A	A⁺	A⁺⁺	A⁺⁺⁺
<30%	≥30%	≥34%	≥36%	≥75%	≥82%	≥90%	≥98%	≥125%	≥150%

Boiler and supplementary heat pump installed with low temperature heat emitters at 35°C ?

from fiche of heat pump

⑦
 $\text{input} + (50 \times \text{'II'}) = \text{input} \%$

The energy efficiency of the package of products provided for in this fiche may not correspond to its actual energy efficiency once installed in a building, as this efficiency is influenced by further factors such as heat loss in the distribution system and the dimensioning of the products in relation to building size and characteristics.

AD-3000743-01

- I The value of the seasonal space heating energy efficiency of the preferential space heater, expressed in %.
- II The factor for weighting the heat output of preferential and supplementary heaters of a package as set out in the following table.

- III The value of the mathematical expression: $294/(11 \cdot \text{Prated})$, whereby 'Prated' is related to the preferential space heater.
- IV The value of the mathematical expression $115/(11 \cdot \text{Prated})$, whereby 'Prated' is related to the preferential space heater.

Weighting of boilers

Psup / (Prated + Psup) ⁽¹⁾⁽²⁾	II, package without hot water storage tank	II, package with hot water storage tank
0	0	0
0.1	0.3	0.37
0.2	0.55	0.70
0.3	0.75	0.85
0.4	0.85	0.94
0.5	0.95	0.98
0.6	0.98	1.00
≥ 0.7	1.00	1.00

(1) The intermediate values are calculated by linear interpolation between the two adjacent values.
 (2) Prated is related to the preferential space heater or combination heater.

Package efficiency

Potterton Promax System ErP		12	15	18	24	32
Temperature control X	%					
Temperature control Y	%					

Warning !

If you smell gas

Do not operate light switches
Do not operate any electrical equipment
Do not use a telephone in the hazardous area
Extinguish any naked flame and do not smoke
Open windows and doors in the hazardous area
Turn off the gas supply at the meter
Warn any other occupants and vacate the premises
Telephone the National Gas Emergency Service on:-
0800 111 999

Faulty boiler

If it is known or suspected that a fault exists on the boiler, it must not be used until the fault has been corrected by a competent person.

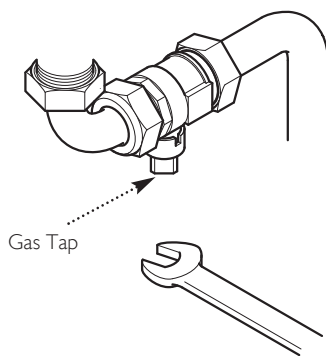
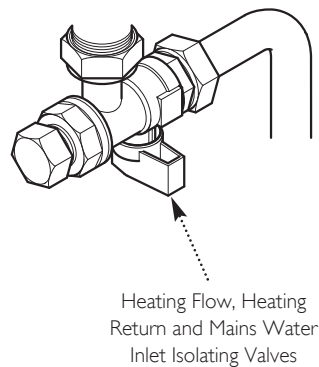

Fig. 6



In an Emergency

If a water or gas leak occurs or is suspected, the boiler can be isolated at the inlet valves as follows;

1. Using a suitable open ended spanner, turn the square nut on the gas tap through 90° ($\frac{1}{4}$ turn) to isolate the gas supply at the boiler (Fig. 6).
3. The water isolating valves are positioned under the boiler and can be closed by turning their taps to the right towards the wall (Fig. 6).
4. Call your Installer or Service Engineer as soon as possible.

10.0 Disposal

10.1 Disposal and Recycling

NOTE: Removal and disposal of the boiler must be carried out by a qualified person in accordance with local and national regulations.

Baxi Customer Support



0344 871 1545

Opening hours

Monday - Friday, 8.00am-6.00pm

Weekends and Bank Holidays, 8.30am-2.00pm

Please note calls may be recorded for training and monitoring purposes



baxi.co.uk

Register now to activate your warranty:

www.baxi.co.uk/registration

For the warranty to be maintained, please make sure...

- 1** Benchmark checklist is completed
- 2** Warranty is registered within 30 days
- 3** The boiler has an annual service

For full terms and conditions, visit www.baxi.co.uk/terms. Failure to adhere to terms and conditions will void your manufacturer's warranty.



Baxi
Brooks House,
Coventry Road,
Warwick, CV34 4LL



Please ensure the boiler is installed in accordance with these installation instructions and that you adhere to the Building Regulations.

e&oe

All descriptions and illustrations provided in this document have been carefully prepared but we reserve the right to make changes and improvements in our products which may affect the accuracy of the information contained in this leaflet. All goods are sold subject to our standard Conditions of Sale which are available on request.

CE
0086



part of **BAXI**