

User Guide and Important Warranty Information

Apollo Condensing Combination Boiler

2 Year Guarantee

To qualify, register now!

Call 0800 731 1644

Visit www.heateam.co.uk



POTTERTON

Please keep these instructions in a safe place.
If you move house, please hand them over to
the next occupier.

Natural Gas

Potterton Apollo 25
G.C.N° 47-393-38

Potterton Apollo 30
G.C.N° 47-393-37

Contents

Section	Page
1.0 Quick Reference Guide	3
2.0 Troubleshooting	4
3.0 Repressurising System	6
4.0 'Intelligent Pre-heat' Feature	7
5.0 Clearances	8
6.0 Care of the Boiler	9
7.0 Legislation	10
8.0 Emergency	11
9.0 Warranty & Service	12

The Benchmark Scheme

Baxi Heating UK Ltd is a licensed member of the Benchmark Scheme which aims to improve the standards of installation and commissioning of domestic heating and hot water systems in the UK and to encourage regular servicing to optimise safety, efficiency and performance.

Benchmark is managed and promoted by the Heating and Hotwater Industry Council. For more information visit www.centralheating.co.uk

© Baxi Heating UK Ltd 2012 All rights reserved. No part of this publication may be reproduced or transmitted in any form or by any means, or stored in any retrieval system of any nature (including in any database), in each case whether electronic, mechanical, recording or otherwise, without the prior written permission of the copyright owner, except for permitted fair dealing under Copyrights, Designs and Patents Act 1988.

Applications for the copyright owner's permission to reproduce or make other use of any part of this publication should be made, giving details of the proposed use, to the following address:

The Company Secretary, Baxi Heating UK Ltd,
Brooks House, Coventry Road, Warwick. CV34 4LL

Full acknowledgement of author and source must be given.

WARNING: Any person who does any unauthorised act in relation to a copyright work may be liable to criminal prosecution and civil claims for damages.

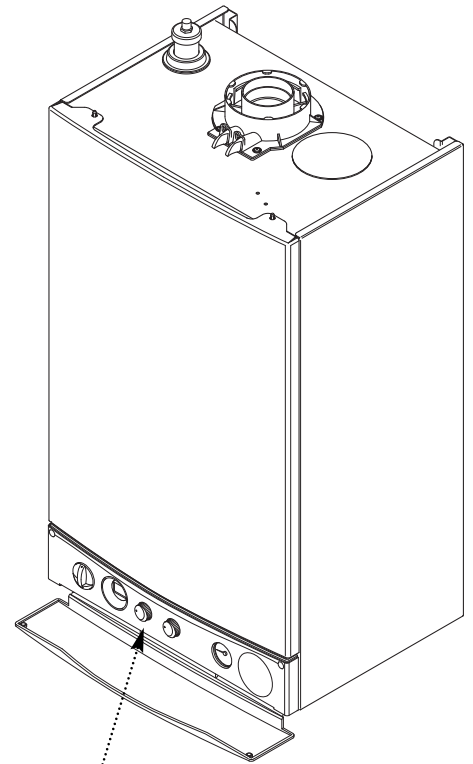

Boiler Controls - see opposite page for Operating Quick Reference Guide



ISO 9001
FM 00866

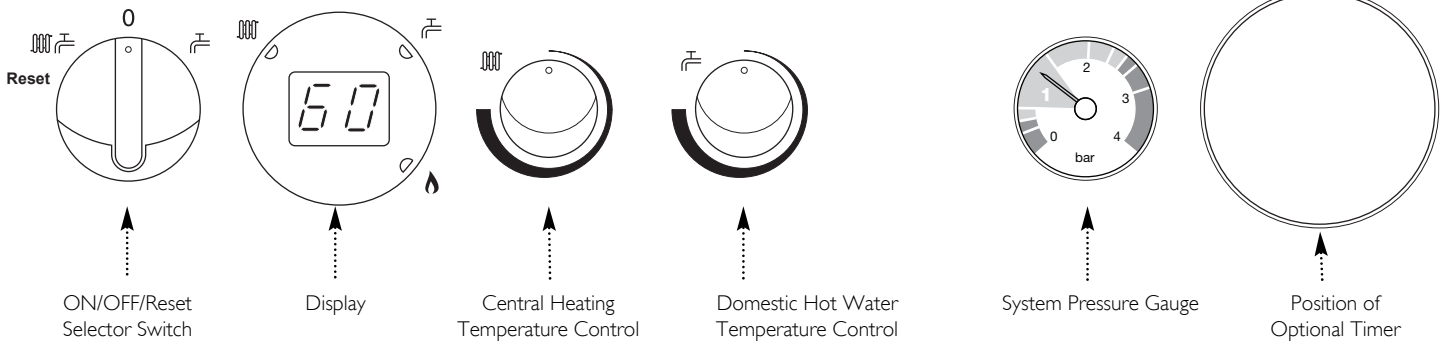

ON/OFF/Reset Selector Switch

Display

Central Heating Temperature Control

Domestic Hot Water Temperature Control

System Pressure Gauge

Position of Optional Timer

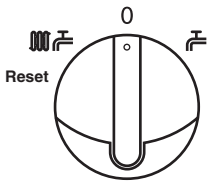

OFF Position

The boiler will not operate.

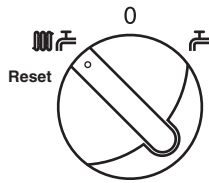

Central Heating & Hot Water

Both Heating & Hot Water will operate.

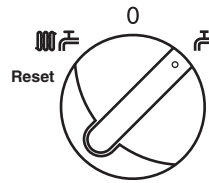

Domestic Hot Water

Hot Water will operate.

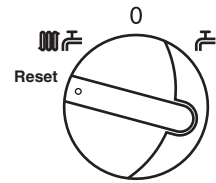

Reset

Hold for approx 5 seconds and release.

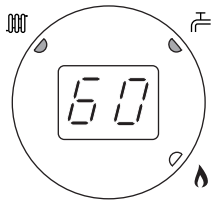

Display



Central Heating Indicator - The indicator will illuminate when the boiler is in the central heating mode.



Domestic Hot Water Indicator - The indicator will illuminate when hot water is being supplied to a tap or shower.



Burner On Indicator - The indicator will illuminate when the burner has fired and is heating your central heating or domestic hot water.

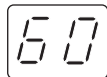

Boiler Output Temperature - In either the central heating or domestic hot water position the display will illuminate showing the current boiler temperature in degrees centigrade.

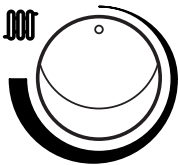

Central Heating Temperature Control

Turn the knob clockwise to increase or anticlockwise to decrease the temperature. Range 25 - 80° C.

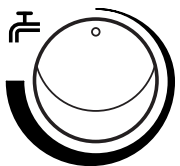

Domestic Hot Water Temperature Control

Turn the knob clockwise to increase or anticlockwise to decrease the temperature. Range 35 - 60° C.



Central Heating System Pressure - The normal operating water pressure is shown when the needle is in the GREEN section of the gauge, between 1 and 2.5 bar. If the pressure exceeds 3 bar (needle in the RED section) the safety pressure valve will operate and a fault is indicated. Contact your Installer.

Boiler not working

2.0 Troubleshooting

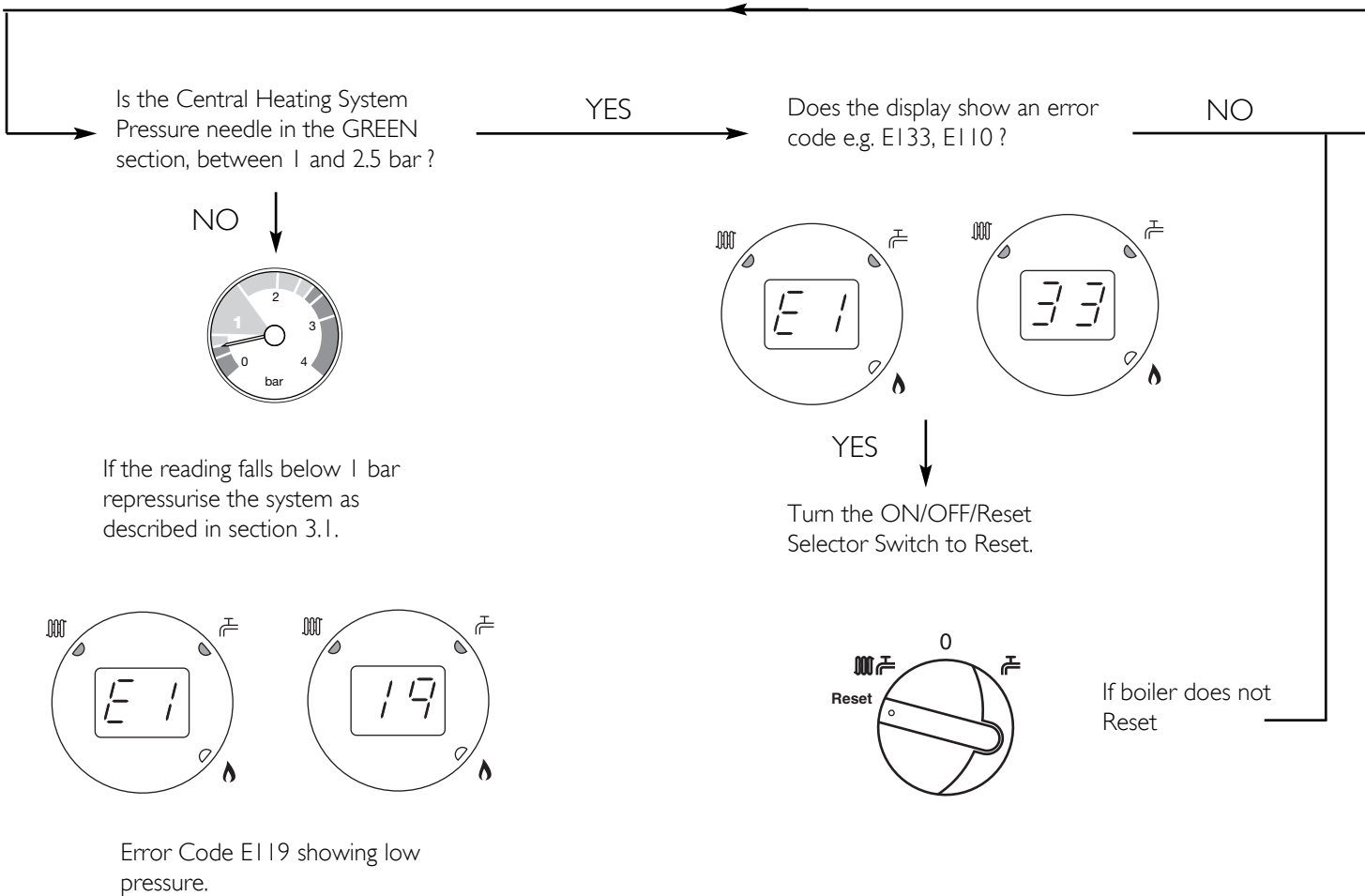
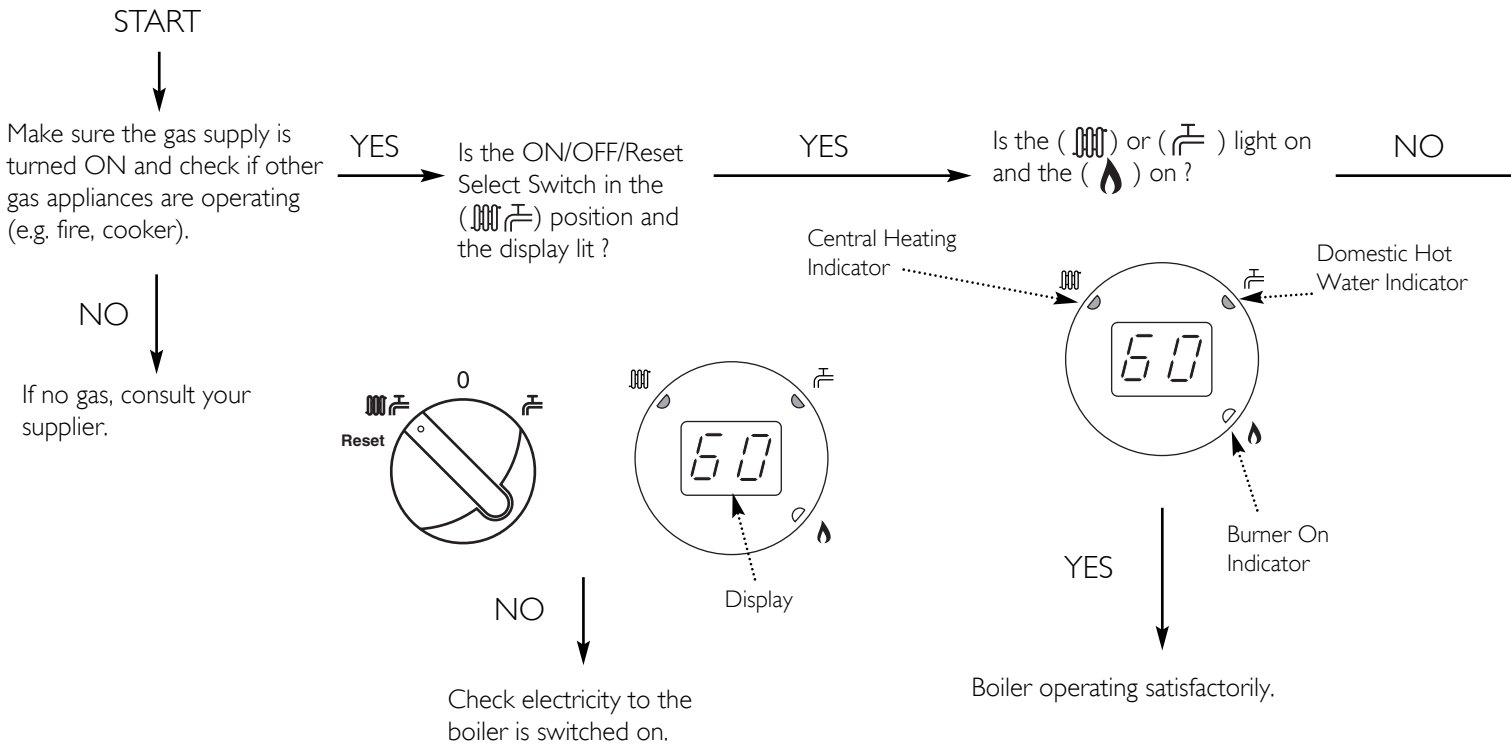

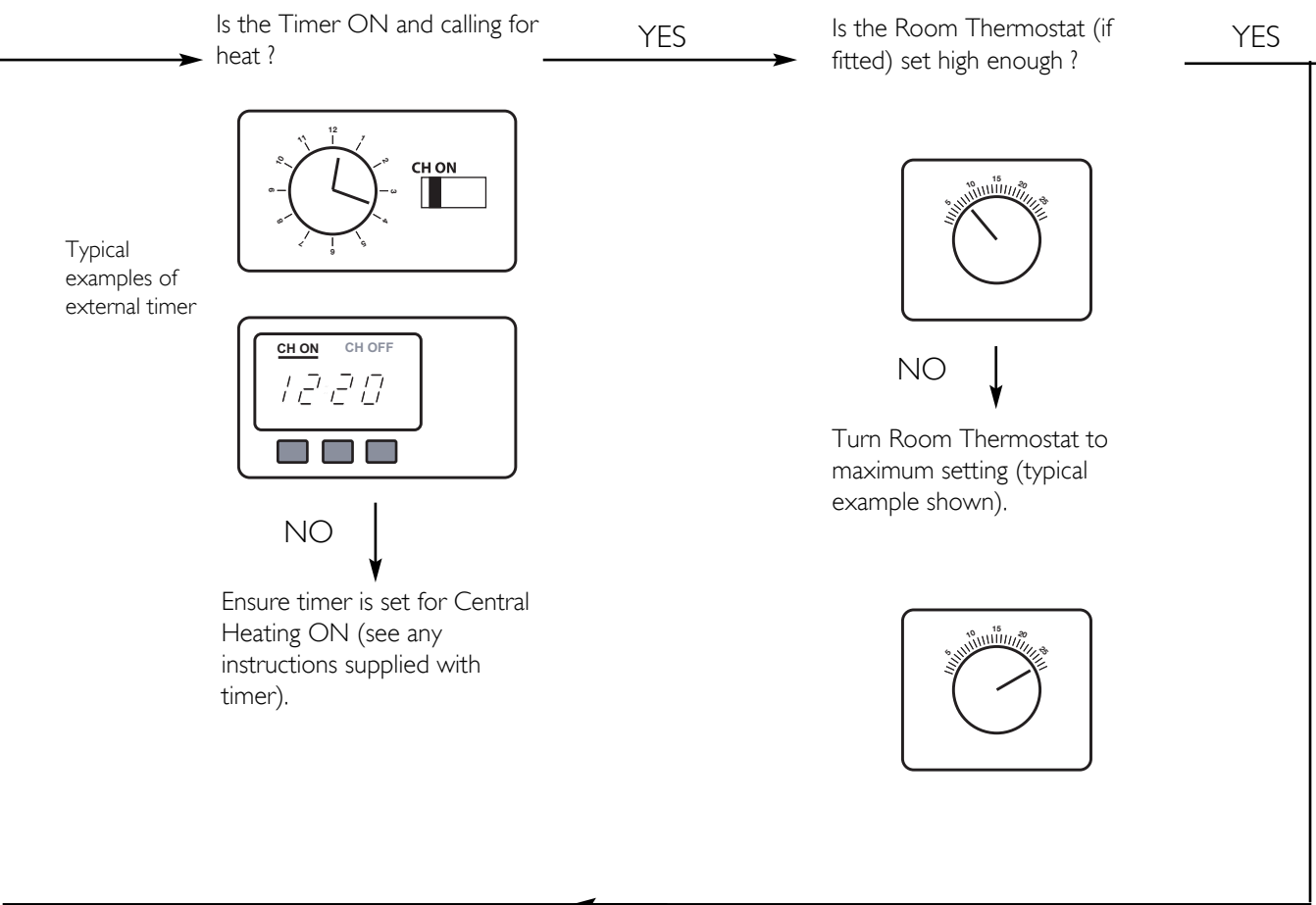

If you don't know what you need to do to get the boiler to light, or need help with the system and controls, contact your installer as soon as possible.

3.0 Repressurising System

3.1 Central Heating System Pressure

1. The normal operating water pressure is when the needle is in the GREEN section of the gauge, between 1 and 2.5 bar (Fig. 1). If the pressure exceeds 3 bar (needle in the RED section) the safety pressure valve will operate and a fault is indicated. Contact your installer.

2. It may be necessary to repressurise the system occasionally (Fig. 2). The needle will be in the lower RED section of the gauge, between 0 and 0.5.

3. A filling device (the filling loop) will be fitted on the system. This will be on the boiler itself or on pipework near to the boiler.

4. If you are unsure of its position, or cannot identify it, consult the installer who fitted the boiler.

5. The filling loop consists of two taps and a separate flexible pipe with connection fittings.

6. Only when repressurising should the flexible pipe be connected between the two taps. Ensure that the nuts on the pipe ends are tightened onto the taps.

7. Fully open one of the taps first, and then while watching the pressure gauge, carefully open the second tap.

8. When the needle on the gauge is indicating 1 or more, in the green section of the gauge, turn both taps off.

9. Disconnect the flexible pipe from the taps (a small amount of water may be present) and remove it. Keep the pipe in a safe place for future use.

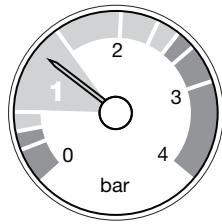

Fig. 1

Normal Pressure

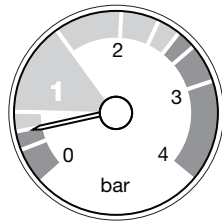

Fig. 2

Requires
Repressurising

4.0 'Intelligent Pre-heat' Feature

4.1 Operation of Pre-heat

1. The boiler incorporates an intelligent pre-heat feature that will ensure optimum domestic hot water performance.

2. This feature 'learns' the domestic hot water demand, and pre-heats the boiler primary circuit (main heat exchanger, pipework within the boiler case and domestic hot water heat exchanger) in anticipation of further demand at the same time on the next day.

3. The feature works on a 24 hour basis. If for example there is a demand for hot water at 7:00 AM on Monday, the pre-heat will operate at 6:50 AM on Tuesday for 1 hour. Similarly if there is a demand at 9:25 PM, the pre-heat will operate at 9:15 PM the next day, again for 1 hour.

4. If on Tuesday at 7:00 AM there is no hot water demand there will be no pre-heat on Wednesday at this time.

5. The feature also operates for one hour after each demand to maintain the temperature of the boiler.

6. There can be up to 24 pre-heat operations in a 24 hour period. While operating in the pre-heat mode the boiler will fire up briefly 3 or 4 times in the hour to maintain the boiler at temperature.

7. During the pre-heat period the domestic hot water indicator will flash (Fig. 6).

8. The pre-heat feature will not operate if the DHW Temperature Control is turned fully anticlockwise (Fig. 4). In this position the boiler will operate as a conventional combination boiler, providing hot water at 50° C.

9. Once the Temperature Control is turned approximately 30° clockwise (Fig. 5) the pre-heat feature is activated.

10. Between 30° and fully clockwise the hot water temperature can be altered from 40° and 60° C.

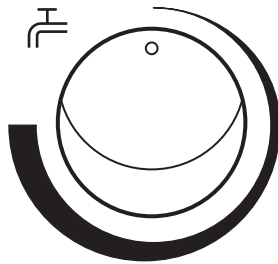

Fig. 4

Pre-heat Off

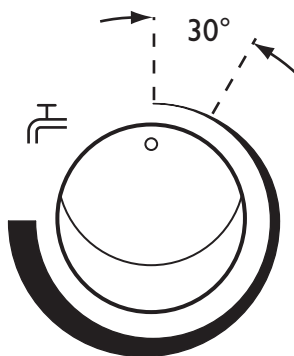

Fig. 5

Pre-heat Activated

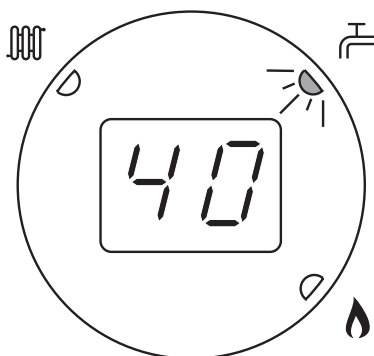

Fig. 6

5.0 Clearances

5.1 For your Safety

1. This appliance must have been installed in accordance with the manufacturer's instructions and the regulations in force.

2. Any modification that may interfere with the normal operation of the appliance without express written permission from the manufacturer or his agent could invalidate the appliance warranty. In GB this could also infringe the Gas Safety (Installation and Use) Regulations.

GB - Heating Industry definition meaning England, Scotland, Wales, Northern Ireland, Isle of Man and the Channel Isles

3. Your boiler must not be operated without the casing correctly fitted.

4. Do not interfere with any sealed components on this boiler.

5. Take note of any warning labels on your boiler.

6. Your boiler should have the following minimum clearances for Safety and Maintenance (Figs. 7 & 8):-

Top	- 200mm
Bottom	- 200mm
Left side	- 5mm
Right Side	- 5mm
Front	- 5mm (In Operation)
	- 450mm (For Servicing)

7. If your boiler is installed in a compartment, do not use it for storage purposes. Do not obstruct any purpose provided ventilation openings.

8. Flammable materials must not be stored in close proximity to your boiler.

9. Avoid skin contact when your boiler is in operation, as some surfaces may get hot e.g. pipework.

10. Ensure that the flue terminal, outside the house, does not become damaged or obstructed, particularly by foliage.

11. It is important that the condensate drain system is not blocked, modified or damaged in any way as this would affect the operation of your boiler. Your installer should have insulated any exposed pipework.

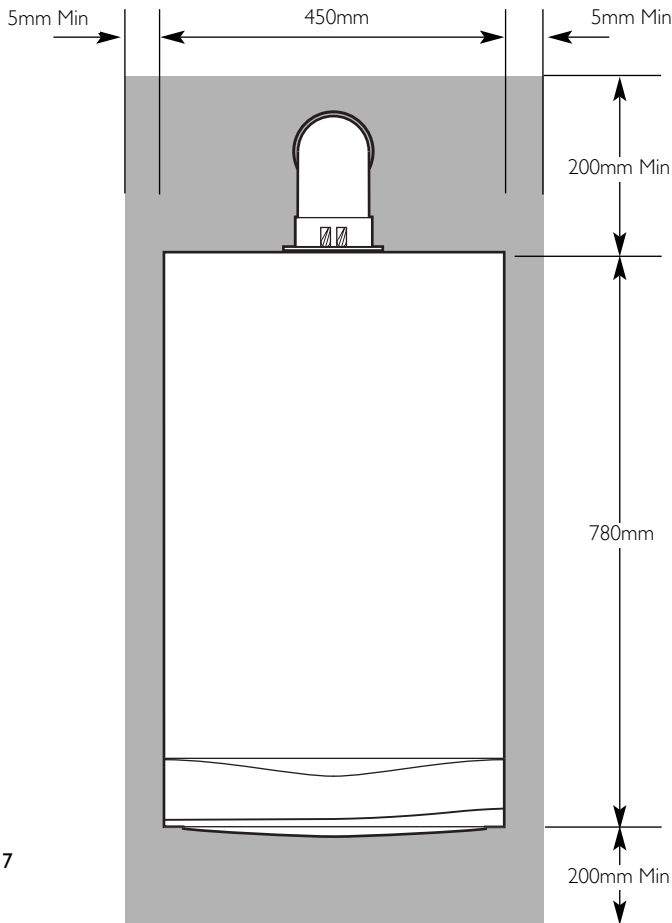

Fig. 7

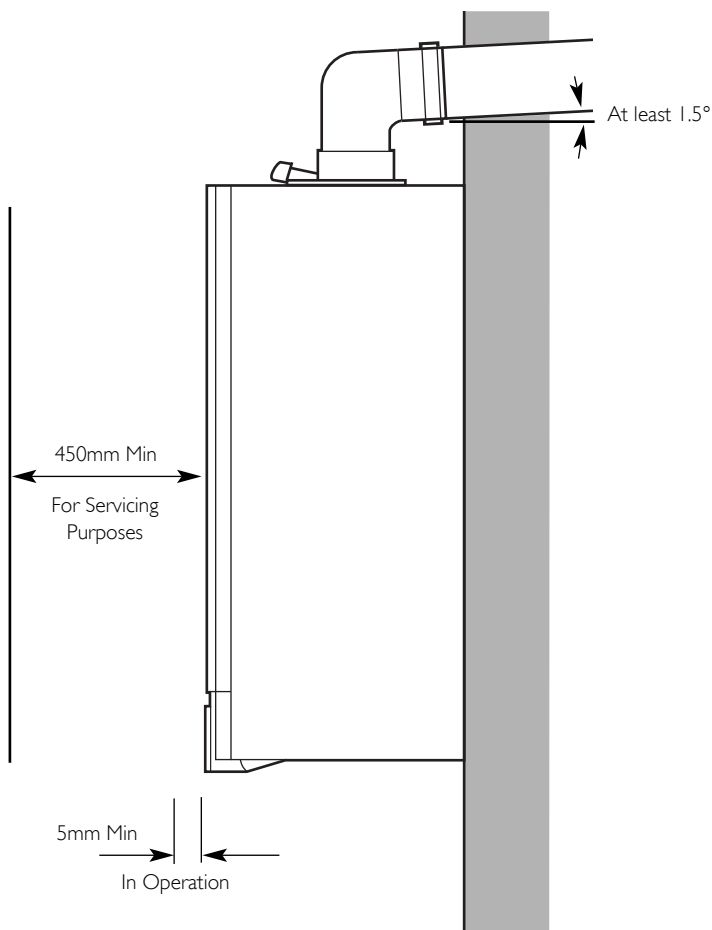

Fig. 8

6.0 Care of the Boiler

6.1 Cleaning the Outer case

The painted panels should be wiped with a damp cloth and then dried completely. **DO NOT USE ABRASIVE CLEANING AGENTS.**

6.2 Protection & Precaution

1. The boiler incorporates an integral frost protection feature that will operate in both modes. If the boiler temperature falls below 5° C, then the boiler will operate until the water temperature has been raised.
2. If a system frost thermostat has been fitted (your installer will be able to advise you), then to operate correctly and protect your system, the gas and electricity must be left on and the appliance set in the central heating mode.
3. The boiler incorporates an integral pump protection feature which continually monitors the time since the pump last operated. To prevent seizure, the pump will operate for approximately 1 minute if it has not run in the last 24 hours.

6.3 Fault Indication

1. If a fault occurs on the boiler an error code may be shown on the facia display (Fig. 9).
2. The codes are either two or three digit, preceded by the letter 'E'. For example, code E133 will be displayed by 'E1' alternating with '33'. E50 is shown as 'E' then '50'.
3. E20, E28, E50 & E160 indicate faulty components. You should make a note of the displayed error code and contact your installer or service engineer.
4. If E110 is displayed overheat of the primary water or flue system has occurred. Turn the selector switch to the reset position and hold for at least 5 seconds. If the boiler does not relight, or the code is displayed regularly contact your installer or service engineer.
5. E119 is displayed when the primary water pressure is less than 0.5 bar. After repressurising the system the boiler should operate. Your installer will be able to advise you about the method of repressurising. See page 6 for further details.
6. E133 indicates that the gas supply has been interrupted, ignition has failed or the flame has not been detected. Ensure that the gas supply has not been turned off, and turn the selector switch to the reset position and hold for at least 5 seconds. If the boiler does not relight, or the code is displayed regularly contact your installer or service engineer.

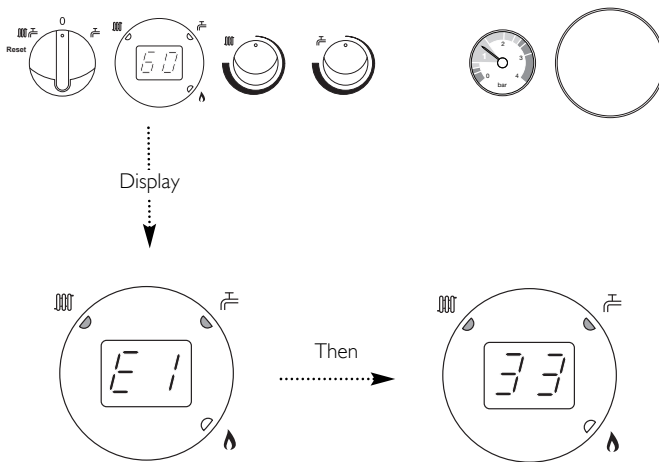

Fig. 9

Table of Error Codes

E20	Central Heating NTC Fault
E28	PCB Fault
E50	Hot Water NTC Fault
E110	Safety Thermostat Operated
E119	Water Pressure Switch Not Operated
E133	Interruption Of Gas Supply or Flame Failure
E160	Fan or Fan Wiring Fault

7.0 Legislation

7.1 Installation, Commissioning, Service & Repair

1. This appliance must be installed in accordance with the manufacturer's instructions and the regulations in force. Read the instructions fully before installing or using the appliance.
 2. In GB, this must be carried out by a competent person as stated in the Gas Safety (Installation & Use) Regulations.
 3. **Definition of competence:** A person who works for a Gas Safe registered company and holding current certificates in the relevant ACS modules, is deemed competent.
 4. In IE (Eire), this must be carried out by a competent person as stated in I.S. 813 "Domestic Gas Installations".
-

All Gas Safe registered engineers carry an ID card with their licence number and a photograph. You can check your engineer is registered by telephoning 0800 408 5500 or online at www.gassaferegister.co.uk

The boiler meets the requirements of Statutory Instrument "The Boiler (Efficiency) Regulations 1993 No 3083" and is deemed to meet the requirements of Directive 92/42/EEC on the energy efficiency requirements for new hot water boilers fired with liquid or gaseous fuels:-

Type test for purpose of Regulation 5 certified by:
Notified Body 0086.

Product/Production certified by:
Notified Bodies 0086.

For GB/IE only.

7.2 Benchmark Commissioning Checklist

1. Please ensure that the installer has fully completed the Benchmark Checklist on the inside back pages of the installation instructions supplied with the product and that you have signed it to say that you have received a full and clear explanation of its operation. The installer is legally required to complete a commissioning checklist as a means of complying with the appropriate Building Regulations (England and Wales).
 2. All installations must be notified to Local Area Building Control either directly or through a Competent Persons Scheme. A Building Regulations Compliance Certificate will then be issued to the customer who should, on receipt, write the Notification Number on the Benchmark Checklist.
 3. This product should be serviced regularly to optimise its safety, efficiency and performance. The service engineer should complete the relevant Service Record on the Benchmark Checklist after each service.
 4. The Benchmark Checklist may be required in the event of any warranty work.
-

Warning !

If you smell gas

Do not operate light switches
Do not operate any electrical equipment
Do not use a telephone in the hazardous area
Extinguish any naked flame and do not smoke
Open windows and doors in the hazardous area
Turn off the gas supply at the meter
Warn any other occupants and vacate the premises
Telephone the National Gas Emergency Service on:-
0800 111 999

Faulty boiler

If it is known or suspected that a fault exists on the boiler, it must not be used until the fault has been corrected by a competent person.

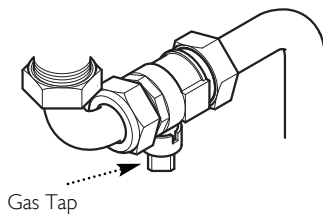

Gas Tap

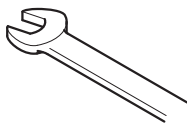
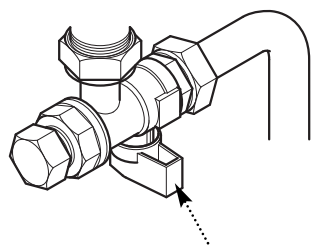

Fig. 10



Heating Flow, Heating
Return and Mains Water
Inlet Isolating Valves

In an Emergency

If a water or gas leak occurs or is suspected, the boiler can be isolated at the inlet valves as follows:

1. Using a suitable open ended spanner, turn the square nut on the gas tap through 90° (1/4 turn) to isolate the gas supply at the boiler (Fig. 10).
2. The water isolating valves are positioned under the boiler and can be closed by turning their taps to the right towards the wall (Fig. 10).
3. Call your Installer or Service Engineer as soon as possible.

Please complete the boxes below

Serial Number

Date of Installation

D	D	M	M	Y	Y

Installer Details (name, address and contact number(s))

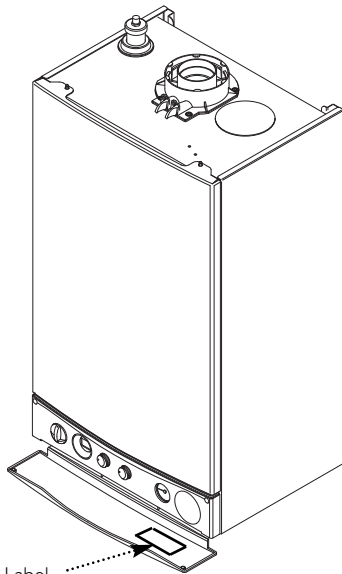

All descriptions and illustrations provided in this leaflet have been carefully prepared but we reserve the right to make changes and improvements in our products which may affect the accuracy of the information contained in this leaflet. All goods are sold subject to our standard Conditions of Sale which are available on request.

POTTERTON

A Trading Division of Baxi Heating UK Ltd (3879156)
Brooks House, Coventry Road, Warwick. CV34 4LL
After Sales Service 0844 871 1560 Technical Enquiries 0844 871 1555
Website www.potterton.co.uk
e&oe

PART OF BDR THERMEA

9.0 Warranty & Service

Standard Warranty Terms & Conditions

To activate your second year free warranty you must register your boiler with **heateam** the service division of Baxi Heating UK Ltd either by completing and returning the registration card or calling our telephone registration line on **0800 731 1644**.

It is also a requirement of the warranty that the boiler has an annual service (every 12 months) in accordance with the installation and servicing instructions, performed by a Gas Safe registered engineer.

If you would like **heateam** to carry this out please call on **0844 871 1560**.

Our promise to you

If you experience a fault with your new boiler, we aim to provide a safe and high quality repair service supported by our dedicated national network of highly skilled engineers. If your installer can't resolve the problem for you, we will do everything we can to get an engineer out to you as quickly as possible. Nothing in this warranty will affect your statutory consumer rights.

What you need to do if you experience a problem with your heating system or the operation of the boiler

You should always contact your installer first, because the cause of the fault may not be related to the boiler. If your installer confirms that the fault is with the boiler and he/she can't repair it, our friendly customer service team is on hand to help. Simply call our service division **heateam** on **0844 871 1560** to book an engineer visit or for any general advice that you may need. Our contact centre is open Monday to Friday 8am - 6pm, weekends and Bank Holidays 8.30am - 2pm, excluding Christmas Day and New Years Day.

When calling **heateam** it would be helpful if you could have the following information to hand:-

- 1 Boiler serial number (see opposite).
- 2 Boiler make and model number.
- 3 Your installer name and address details.
- 4 Proof of purchase (if you do not have the boiler serial number).

What this warranty covers

Free of charge repair or replacement of components found to be of faulty manufacture.

Free of charge replacement of the complete unit provided always that the failure is related to a manufacturing fault that cannot be repaired or is uneconomic to repair.

What this warranty does not cover

Repairs to boilers which haven't been installed and commissioned properly, and as set out in the installation instructions (this includes the need to flush the system effectively and add a suitable corrosion inhibitor).

Any damage caused by hard water scale deposits and/or aggressive water resulting from corrosion.

Any other defects or failures, either in the connected heating system or outside of the boiler itself.

Faults caused by inadequate supply of electricity, gas or water to the property.

Installations within commercial settings for which this boiler was not designed.

Reimbursement of any third party repair or replacement costs that we haven't been told about or agreed with you in advance.

Compensation for consequential losses (e.g. loss of earnings, business losses, stress and inconvenience) arising from a production breakdown, including repair delays caused by factors outside our reasonable control.

After Sales Service 0844 871 1560