

Series SBO

Oil Steam Boilers

Installation, Operation & Maintenance Manual

TO THE INSTALLER:

This manual is the property of the owner and must be affixed near the boiler for future reference.

TO THE OWNER:

This boiler should be inspected annually by a Qualified Service Agency.

Service Information

Name: _____

Address: _____

Phone: _____



ECR International Inc.
2201 Dwyer Avenue, Utica, NY 13501 Tel.
800 325 5479
www.ecrinternational.com
PN 240013301 REV. B [02/23/2021]

TABLE OF CONTENTS

USING THIS MANUAL	1	5. BURNER SETUP & BOILER OPERATION	10
A. INSTALLATION CLEARANCE	1	A. BURNER INSTALLATION	10
B. SPECIAL ATTENTION BOXES	1	B. BURNER START-UP & ADJUSTMENT	10
1. PREINSTALLATION	2	C. CHECK BOILER CONTROLS	10
A. CLEARANCES	2	D. FILL THE BOILER	10
B. AIR FOR COMBUSTION & VENTILATION	2	E. CLEAN THE BOILER	10
C. CHIMNEY / VENT & DRAFT CONTROL	3	6. MAINTENANCE	12
D. PLANNING THE LAYOUT	3	A. GENERAL	13
E. BOILER WATER TREATMENT	3	B. DAILY MAINTENANCE (WITH BOILER OPERATING)	13
2. BOILER PLACEMENT & ASSEMBLY	4	C. MAINTENANCE OF SAFETY RELIEF VALVE	13
A. SETTING THE BOILER	4	D. MONTHLY MAINTENANCE (WITH BOILER OPERATING)	13
B. FLUE OUTLET	4	E. MAINTENANCE – ANNUAL	13
3. PIPING & CONTROLS	5	F. IF A LONG SHUTDOWN IS REQUIRED	14
A. PRESSURE TEST BLOCK ASSEMBLY	5	7. BOILER DIMENSIONS & RATINGS	15
B. BOILER RETURN CLEARANCE	5	8. REPAIR PARTS	16
C. STEAM BOILER PIPING	6		
D. TANKLESS HEATER OR COVERPLATE	7		
E. CONTROLS	7		
4. ELECTRICAL	8		
A. GENERAL	8		
B. WIRING	8		

USING THIS MANUAL

A. INSTALLATION CLEARANCE

Follow the installation instructions provided in this manual in the order shown. The order of these instructions has been set in order to provide the installer with a logical sequence of steps that will minimize potential interferences and maximize safety during boiler installation.

B. SPECIAL ATTENTION BOXES

Throughout this manual you will see special attention boxes intended to supplement the instructions and make special notice of potential hazards. These categories mean, in the judgment of manufacturer.

DANGER

Indicates a hazardous situation, which, if not avoided, will result in death or serious injury and major property damage.

WARNING

Indicates a hazardous situation, which, if not avoided, could result in death or serious injury and major property damage.

CAUTION

Indicates a hazardous situation, which, if not avoided, could result in minor or moderate injury, and minor property damage.

NOTICE

Indicates special attention is needed, not related to personal injury or property damage.

1. PREINSTALLATION

WARNING

This manual is intended for use by Qualified Heating Professionals only. Installation, service, or adjustment of this heating appliance by anyone other than a Qualified Heating Professional can cause significant property damage, personal injury, or death.

Read carefully, study these instructions before beginning work. It will save time. Study the included drawings. Save these instructions for reference.

The boiler warranty can be voided if the boiler is not installed, maintained and serviced correctly.

NOTICE

The equipment shall be installed in accordance with those installation regulations in force in the local area where the installation is to be made, including the current edition of *NFPA-31, Standard for the Installation of Oil-Burning Equipment*. These shall be carefully followed in all cases. Authorities having jurisdiction shall be consulted before installations are made.

CAUTION

Never burn garbage or paper in the unit, and never leave combustible material around it.

CAUTION

Do not tamper with boiler controls.

A. CLEARANCES

Table 1.1: Clearances from Jacket and Vent System

Required from Jacket to Combustible Construction		Recommended From Jacket for Accessibility and Mounting Controls
Top	5"*	24" to clean flueways.
Front	16.5"*	16.5" from jacket due to burner.
Left	2"*	12" due to burner swing radius.
Right	2"*	18" on steam with tankless heater
		9" in area of boiler service switch and junction box.
Rear	2"*	9" for mounting relief valve in standard location**.
Vent Pipe (Single Wall) - 9" to Combustible Construction. Clearance may be reduced using methods in NFPA 31.		
Vent Pipe (Double Wall) - See Manufacturer's Instructions.		

* Consider also vent pipe clearance, including distance from edge of flue outlet to combustible construction (as applicable).

** See dimensional drawing for alternate relief valve location.

Unit may be installed on combustible flooring, provided the boiler is not set on carpet and a metal drip pan is placed under the appliance.

Unit may be installed in a closet with the above clearances. See also Section B, Air for Combustion and Ventilation.

B. AIR FOR COMBUSTION & VENTILATION

1. Be certain adequate facilities are available to provide air for satisfactory combustion and ventilation.
2. Appliances Located in Unconfined Spaces (a space whose volume is equal to or greater than 50 cubic feet per 1,000 Btu/hr of the aggregate input rating of all fuel-burning appliances installed in that space).
 - a. For installation in unconfined spaces with conventional construction and larger areas such as basements, the supply of air for combustion and ventilation can usually be considered adequate.
3. Appliances Located in Confined Spaces (a space whose volume is less than 50 cubic feet per 1,000 Btu/hr of the aggregate input rating of all fuel-burning appliances installed in that space).
 - a. All air from inside the building: Provide two permanent openings communicating directly with an additional room. If all air for combustion and ventilation is to come from within the building: two openings, one near the ceiling and one near the floor of the boiler room shall be provided with the minimum free area of each opening equal to 140 sq. in. per gallon of oil burned.
 - b. If all air for combustion and ventilation is to come from outside the building: two openings, one near the ceiling and one near the floor of the boiler room shall be provided with the minimum free area of each opening equal to 35 sq. in. per gallon of oil burned.
 - c. If ducts are used to convey the air, areas of 35 sq. in. per gallon of oil burned for vertical ducts or 70 sq. in. per gallon of oil burned for horizontal ducts are to be provided. Ducts shall have the same area as the free area of the openings to which they are connected.

C. CHIMNEY / VENT & DRAFT CONTROL**⚠ WARNING**

This boiler shall be connected to a venting system having sufficient draft. Follow draft requirements listed in Section C below.

Improper venting may result in property damage and the release of flue gases which contain deadly carbon monoxide into the home, which can cause severe personal injury, death, or substantial property damage.

1. Draft Requirement - Minimum draft required in the vent system is $-.03$ " W.C. to $-.06$ " W.C. depending on boiler model, see Table 7.1 (Section 7). This draft is necessary to provide the required draft over fire of $-.01$ " W.C. to $-.02$ " W.C..
2. A barometric draft control is required for regulation of over fire draft. Follow manufacturer's instructions to locate and adjust the control.
3. The vent system and installation must be in accordance with the current edition of ANSI/NFPA 211, "Standard for Chimneys, Fireplaces, Vents, and Solid Fuel Burning Appliances"; NFPA-31, "Standard for the Installation of Oil-Burning Equipment" and in Canada, CSA B 139, "Installation Code for Oil-Burning Equipment" or applicable provisions of local building codes. Typical minimum chimney size is 8" x 8" x 15 feet high, unless otherwise allowed by code. If the vent system is not sized correctly, the burner may not operate properly. This can cause poor combustion, sooting, and odors to occur.
4. NFPA 31 recommends using a listed metal chimney liner to reduce transient low draft during startup and flue gas condensation during cyclic operation. Any doubt on the condition of a chimney or its ability to prevent the generation and accumulation of flue gas condensate, must be lined according to NFPA 31.
5. Inspect the existing chimney, chimney liner, and vent connector. Make sure each are in good condition and repair or replace as required.

⚠ WARNING

A masonry chimney must have a clay flue liner. If flue gas condensation is occurring, install a listed corrosion resistant metal liner.

Failure to install a clay flue liner may cause severe injury or death.

6. Chimney flue gas condensation is affected by a number of factors such as chimney design, flue connector length, sulfur content in fuel oil, and flue gas temperature. If your application experiences flue gas condensation, installation of a listed corrosion resistant metal liner is required.

- External chimneys are more susceptible to flue gas condensation due to exposure to outside air temperatures. To prevent corrosion due to flue gas condensation, use a listed corrosion resistant metal liner.
- When firing the appliance where fuel oil sulfur content exceeds 300ppm, a listed corrosion resistant chimney liner is recommended.

⚠ WARNING

Series SBO is approved at the listed firing rates only. Failure to fire the boiler at its designed input may cause excessive flue gas condensation. In addition, lower input may not create enough draft to adequately evacuate the products of combustion.

D. PLANNING THE LAYOUT

Prepare sketches and notes of the layout of the installation. Include boiler location, venting system, existing piping and wiring. Show existing equipment that may interfere with installation of new equipment.

E. BOILER WATER TREATMENT

Consult a local qualified water treatment specialist for recommendations regarding the appropriate chemical compounds and concentrations which are compatible with local environmental regulations.

1. Boiler water pH should be in the 7.5 to 11 range.
2. Boiler water chloride concentration should be less than 30 ppm.
3. The water hardness should be less than 7 grains per gallon to prevent scale build-up and foaming.

3. PIPING AND CONTROLS

NOTICE

Do not pipe boiler before jacket is installed.

A. PRESSURE TEST BLOCK ASSEMBLY

1. Temporarily provide a cold water supply connection to the boiler.
2. Install pressure gauge in tapping provided. See Boiler Dimensional drawing, Figure 7.1 (Section 7)
3. Plug all open tappings in the boiler and fill with water. Apply approximately thirty (30) psig pressure. Check to make certain that all joints and fittings are water tight.
4. After all joints and connections have been proven tight, remove cold water supply and plugs from all tappings that are to be used. See Figure 7.1 (Section 7) for tapping locations.

B. BOILER RETURN CLEARANCE

If using front return, piping must allow for opening and closing Burner Mounting Plate.

C. STEAM BOILER PIPING

1. Refer to Hydronics Institute Residential Hydronic Heating Installation/Design Guide for assistance.
2. See Figure 3.1. The return loop from system should always enter equalizer through the Hartford Loop, 2" to 4" below normal water line (see dimensional drawing for normal water line).
3. See Table 3.1 and Figure 3.1 for pipe size information.
4. Pipe the steam header a minimum of 24" above the normal water line using swing joints to attach the risers into the steam header.

Table 3.1: Steam Pipe Sizing

Boiler Model No.	Supply Riser	Header	Equalizer
SBO-3	(1) 2"	2" or 3"	1-1/4"
SBO-4	(1) 2"	2" or 3"	1-1/4"

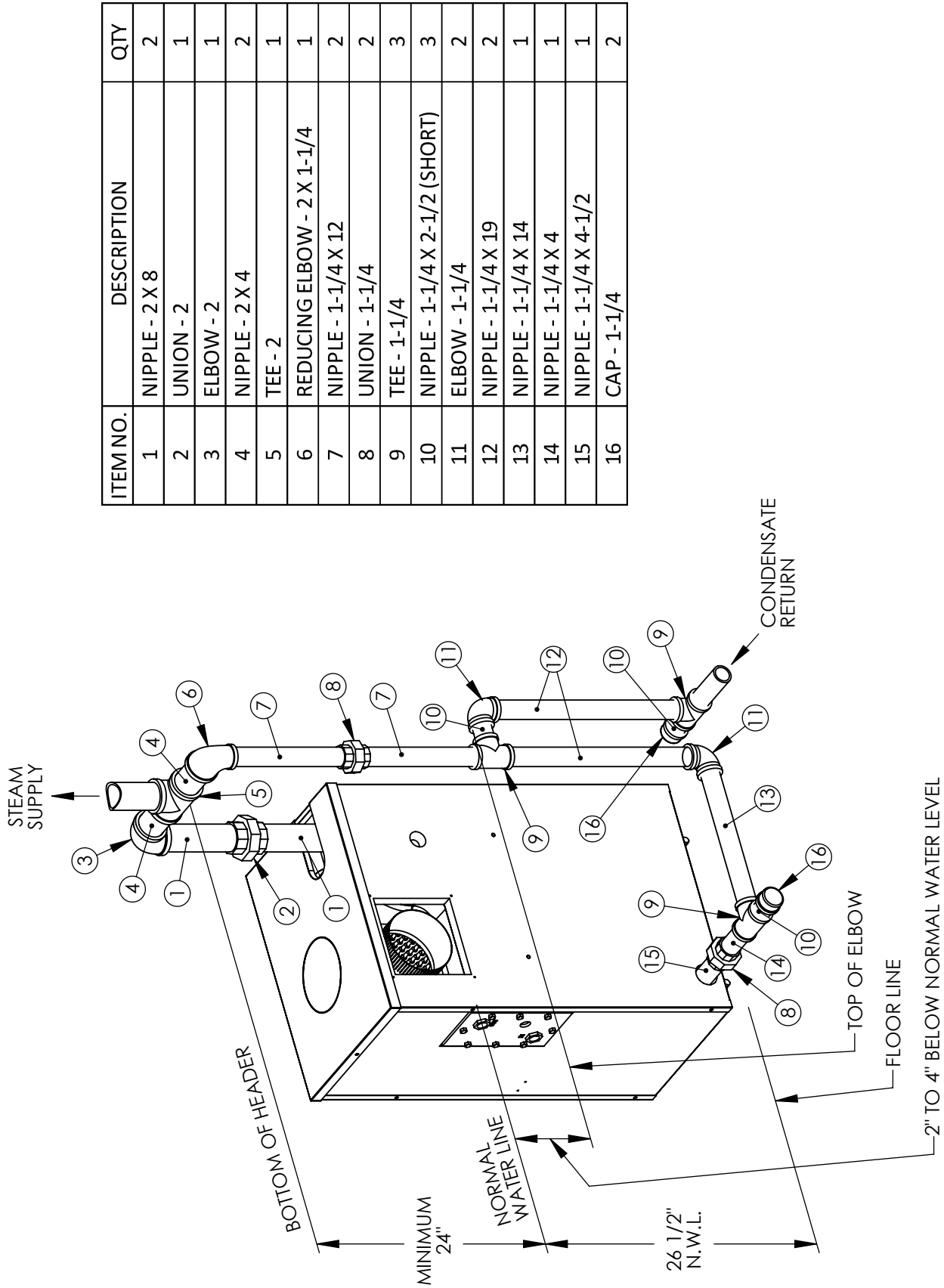

Figure 3.1: Steam; Near Boiler Piping - SBO-3 & SBO-4

D. TANKLESS HEATER OR COVERPLATE

1. If a tankless coil is used (item 9), install in opening in rear section.
2. For suggested piping of tankless water heater refer to Figure 3.2.
3. Install control well for low limit operating control into 3/4" NPT control tapping on tankless heater plate. Install low limit operating control on control well. Wire low limit control to oil burner per Figure 4.2.

⚠ DANGER

Install anti-scald device in hot water supply piping. Water temperature above 125°F can cause severe burns instantly or death from scalds.

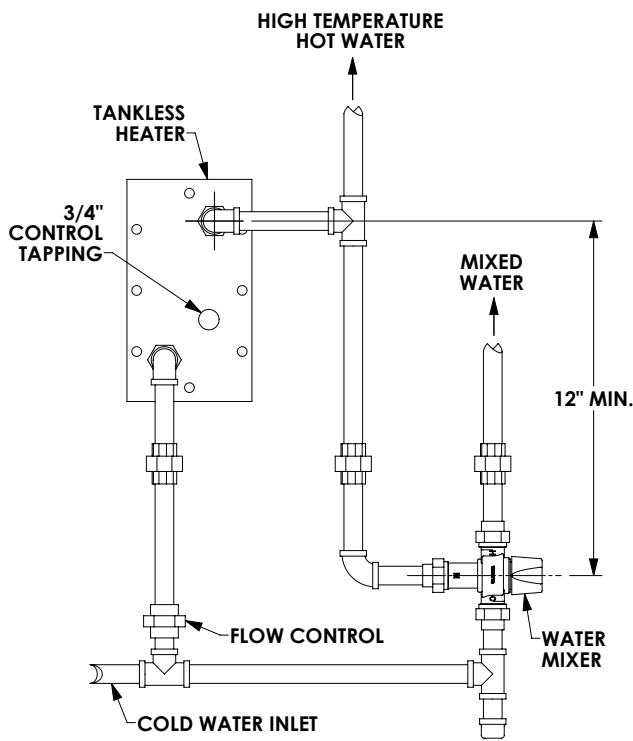

Figure 3.2: Tankless Coil Piping, Steam Boiler

4. If not using a tankless coil, cover the heater opening with cover plate (item 16). Packaged boiler is factory equipped with a cover plate installed.

NOTICE

Be sure rubber gasket is in place between cover plate or water heater plate and boiler section.

E. CONTROLS

1. Steam Boiler Controls:
 - a. Install the gauge glass trim and safety relief valve. See Figure 7.1 (Section 7).
 - b. For installations requiring a second operating control that senses steam pressure (not provided), use a Honeywell PA404A or equivalent. On probe boilers, install the additional pressure control opposite the standard PA404A using a cross instead of a tee along with a second brass siphon (not provided).
 - c. Boiler is factory equipped with Hydrolevel CG450 low water cut off. See Figure 7.1 (Section 7) for location. See also control manufacturers instruction sheet.

⚠ CAUTION

Pipe the discharge of the safety valve or relief valve to prevent injury in the event of pressure relief. Pipe the discharge to a drain. Provide piping that is the same size as the relief valve.

2. For complete information on servicing and adjustment of controls, refer to the attached control specification sheets.

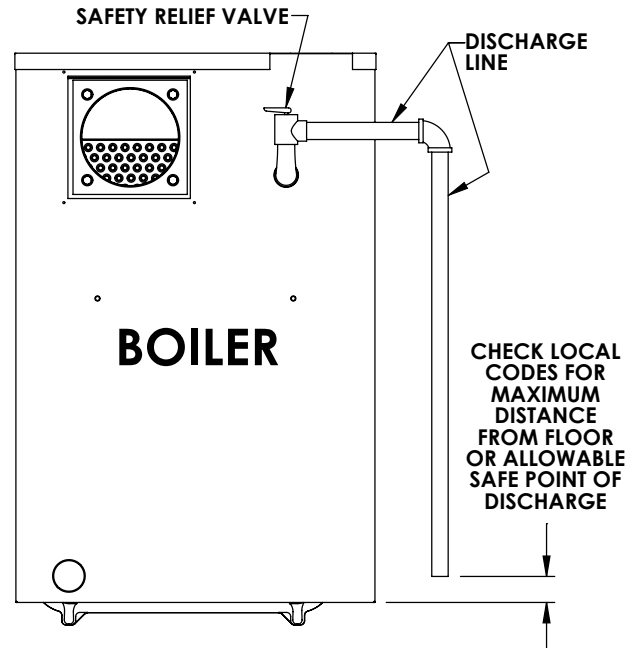

Figure 3.3: Discharge Piping from Safety Relief Valve

4. ELECTRICAL

A. GENERAL

All electrical wiring shall be done in accordance with the National Electrical Code and Local Requirements. Single pole switches including those of safety controls or protective devices shall not be wired in a grounded line.

B. WIRING

1. See Section 5 for mounting burner.

WARNING

Improper installation of burner harness can allow burner to energize with burner mounting plate open, creating a severe burn hazard to boiler maintenance personnel.

2. Burner harness is pre-wired to burner by burner manufacturer. After the burner is mounted, Molex plug on burner harness plugs into mating Molex receptacle in junction box. See Figure 4.1.
3. For complete information on servicing and adjustment of controls, refer to the attached control specification sheets.
4. See Wiring Diagram Figure 4.2 for Steam Boilers with Probe LWCO

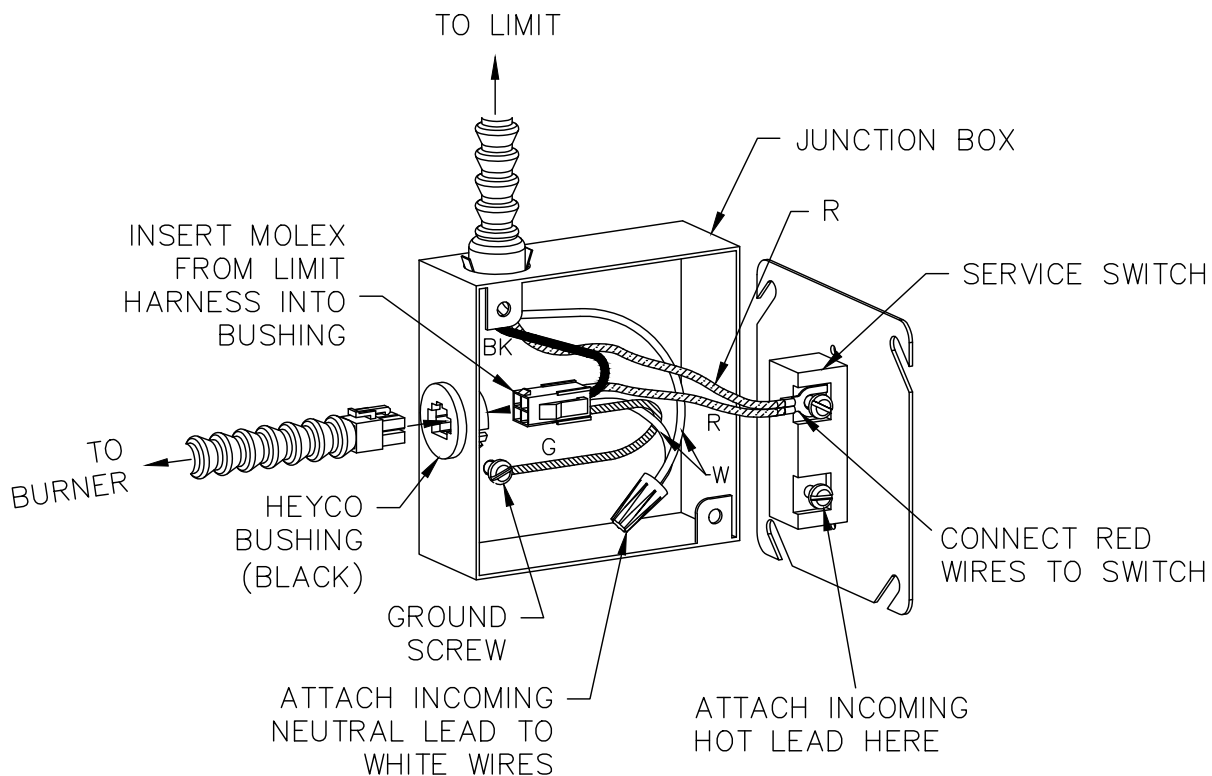
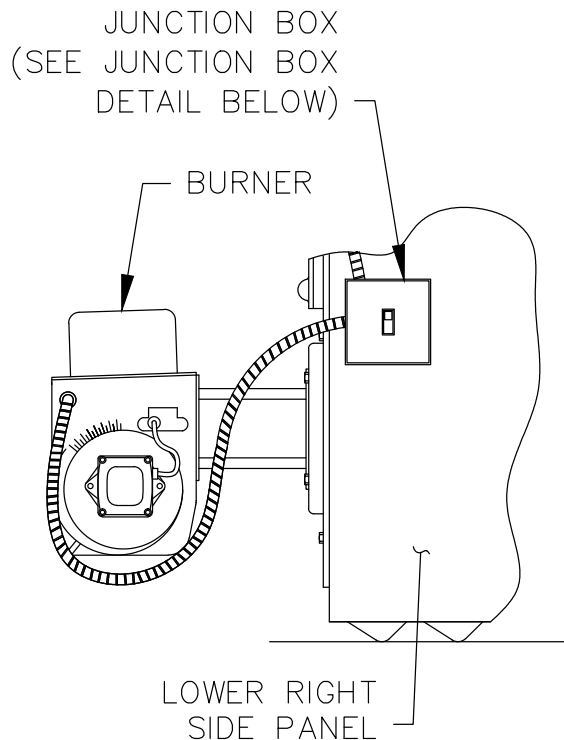

Figure 4.1: Junction Box Wiring, Steam Boilers

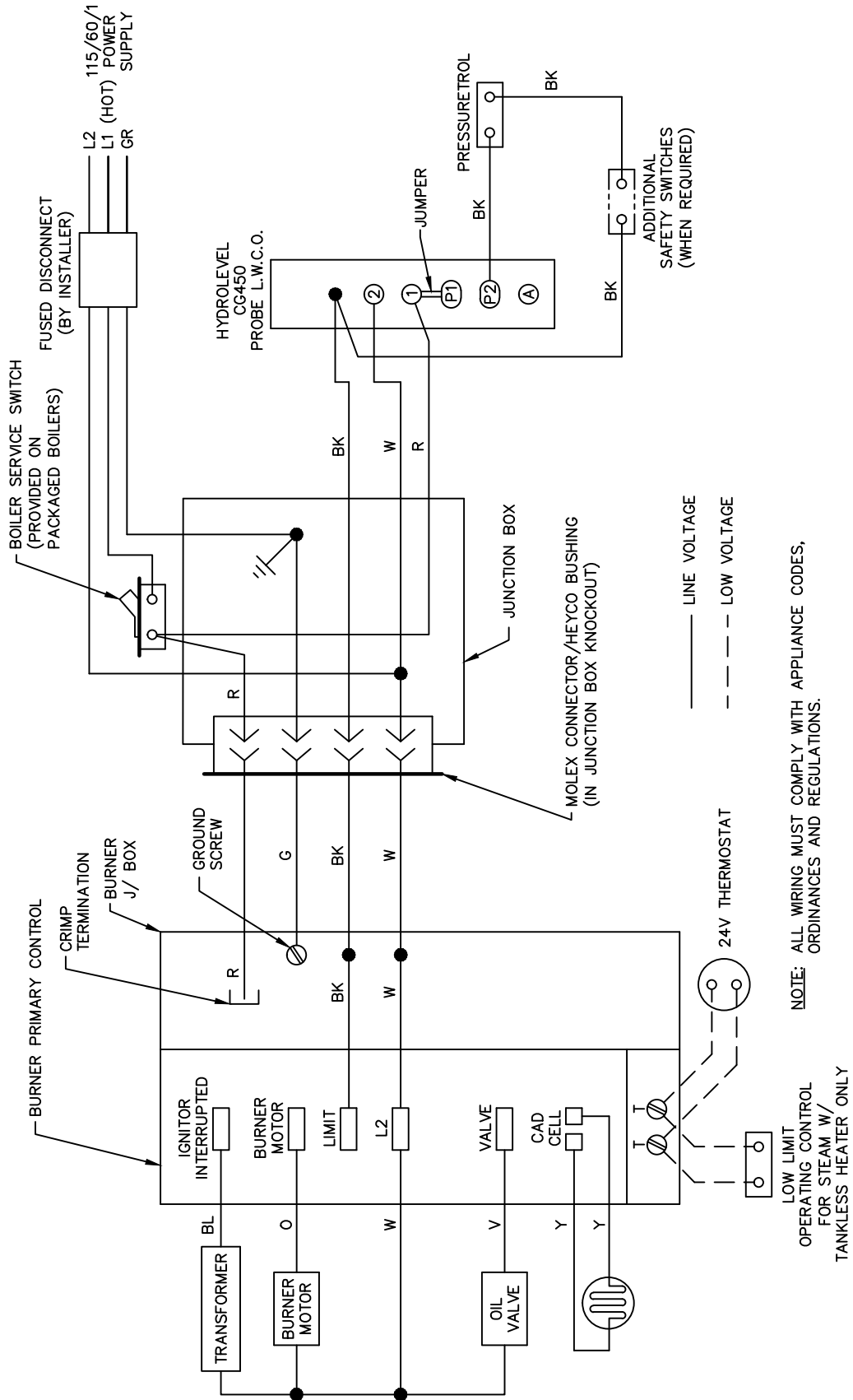

Figure 4.2: Steam with Probe Low Water Cut-off

5. BURNER SETUP & BOILER OPERATION

CAUTION

Burn only #2 Fuel Oil in this appliance. Do not use gasoline, crankcase drainings or any oil containing gasoline.

A. BURNER INSTALLATION

1. The oil burner is supplied with a mounting flange fixed in position.
2. Mount the burner to the burner mounting plate (item 5) with four (4) 5/16" studs and nuts provided.

NOTICE

Be sure hi temp gasket is between the burner mounting flange and the Burner Mounting Plate.

3. Care must be taken when routing the oil lines so not to interfere with the opening and closing of the burner mounting plate. Flexible oil lines or flared copper disconnects with valves (when copper lines are used) may be installed to assure full opening of the burner mounting plate when servicing.
4. Oil burner specifications:
For information pertinent to the oil burner such as nozzle sizing, fuel supply piping, adjusting or servicing, refer to the charts in this section and the burner installation manual.

B. BURNER START-UP & ADJUSTMENT

CAUTION

Do not start the burner unless all cleanout doors are in place.

1. Burner should start automatically when thermostat is turned up and main boiler service switch is turned on. If burner does not start, check to be sure there is oil in the tank and push square red reset button on Beckett burner control.

If burner still does not start, contact serviceman.

CAUTION

Do not attempt to start the burner when excess oil has accumulated, when the unit is full of vapor, or when the combustion chamber is very hot.

2. Adjust burner and barometric draft control for highest CO₂ (Maximum 13.1%) while maintaining a 0 Smoke and a minimum -.01" W.C. draft overfire.

All adjustments must be made using suitable instruments such as found in a Bacharach Combustion Test Kit.

3. Burner and boiler can be shut down by turning down the thermostat and moving the main boiler service switch to the "off" position.
4. See burner manufacturer's manual for further information regarding the burner.

C. CHECK BOILER CONTROLS

1. Limit and Operating Controls:
 - a. Lower the set point of each control until the burner shuts down. Note that the system pressure (or temperature) corresponds to the desired set point.
 - b. Return the controls to the desired set point.
2. Low Water Cut-off - consult the manufacturer's instructions for the low water cut-off operational check procedure.

D. FILL THE BOILER

1. The normal water line for steam boilers with gravity returns is shown in Figure 7.1.
2. For systems with pumped returns or boiler feed units, the fill level will depend on the control being used. Verify the unit maintains a water level that is visible in the gauge glass and does not exceed the normal water level.
3. Check all joints and fittings in the system piping for leaks and repair as necessary
4. See Section 1 - Preinstallation for boiler water treatment requirements.

E. CLEAN THE BOILER

1. Clean the boiler within one week after initial start-up. Cleaning will be more effective if boiler operates a day or two to loosen sediment and impurities in system.
2. Boiler must be cleaned to remove any accumulation of oil, grease, sludge, etc. in the system. These substances can cause foaming and surging of boiler water, producing an unstable water line and water carryover to system.

WARNING

Cleaning the boiler requires the use of very hot water and corrosive chemicals. Use care when handling to prevent injury.

3. Connect a skim valve off the 1-1/4 NPT skim tapping on front of boiler. See Figure 7.1 (Section 7) to locate skim tapping. Run a drain line off skim valve to a point of safe discharge.

4. Provide a means of supplying continuous fresh water to the boiler for the cleaning process.
5. Use common washing soda, such as Arm and Hammer Super Washing Soda. Mix 1/2 pound of soda with water in a 10 quart pail. Pour the mixture into the boiler through the safety relief valve tapping.
6. Open the skim valve. Fill boiler until water begins to flow out of the valve.

CAUTION

Do not leave boiler unattended while firing burner. Operating boiler with water below minimum permissible water level may fracture sections.

7. Turn on burner. Allow boiler water to heat up to just below steaming (180 - 200°F). Do not allow boiler to steam; steaming mixes up contaminants instead of floating them at surface.
8. Open make-up water valve to continually feed water to boiler. Adjust flow to maintain water temperature at 180 - 200° F.

CAUTION

Do not allow make-up water to flow too fast. Excessive quantities of cold water may fracture sections.

9. Continue skimming boiler until water flowing from skim tapping flows clear. This will take some time, possibly several hours for a dirty system.
10. Turn off burner, close make-up water valve.

11. Drain boiler completely. Refill and drain one or two times to wash out all washing soda.
12. Remove skim valve and piping. Install 1-1/4"NPT plug in skim tapping.

NOTICE

If gauge glass becomes dirty more contaminants have worked loose in system. Repeat cleaning and skimming process as needed to clean system.

Table 5.1: Beckett Burner Specifications

BECKETT BURNER SPECIFICATIONS								
Boiler Model No.	Burner Model No.	Burner Head	Static Plate	Nozzle Size	Pump Pressure	Start-up Settings		Head Setting
						Air Shutter	Air Band	
SBO-3085	AFG-F3 ¹	F3	3-3/8"	0.75 80° B HAGO ²	140 PSI	6.0	1	N/A
SBO-3105	AFG-F4	F4	3-3/8"	0.90 80° B HAGO	140 PSI	6.0	0	N/A
SBO-4125	AFG-F4	F4	3-3/8"	1.10 80° B HAGO ²	140 PSI	5.0	2	N/A
SBO-4150	AFG-F6	F6	2-3/4"	1.25 80° B HAGO	140 PSI	8.0	1	N/A

Factory Equipped Burner Cartons are indicated in **Boldface**.

1 Requires Low Firing Rate Baffle.

2 Parts required to convert factory equipped burner to operate at alternate lower firing rate are provided in rerate kits, sold separately.

6. MAINTENANCE

WARNING

Product Safety Information Refractory Ceramic Fiber Product

This appliance contains materials made from refractory ceramic fibers (RCF). Airborne RCF, when inhaled, have been classified by the International Agency for Research on Cancer (IARC), as a possible carcinogen to humans. After the RCF materials have been exposed to temperatures above 1800°F, they can change into crystalline silica, which has been classified by the IARC as carcinogenic to humans. If particles become airborne during service or repair, inhalation of these particles may be hazardous to your health.

Avoid Breathing Fiber Particulates and Dust

Suppliers of RCF recommend the following precautions be taken when handling these materials:

Precautionary Measures:

Provide adequate ventilation.

Wear a NIOSH/MSHA approved respirator.

Wear long sleeved, loose fitting clothing and gloves to prevent skin contact.

Wear eye goggles.

Minimize airborne dust prior to handling and removal by water misting the material and avoiding unnecessary disturbance of materials.

Wash work clothes separately from others. Rinse washer thoroughly after use.

Discard RCF materials by sealing in an airtight plastic bag.

First Aid Procedures:

Inhalation: If breathing difficulty or irritation occurs, move to a location with fresh clean air. Seek immediate medical attention if symptoms persist.

Skin Contact: Wash affected area gently with a mild soap and warm water. Seek immediate medical attention if irritation persists.

Eye Contact: Flush eyes with water for 15 minutes while holding eyelids apart. Do not rub eyes. Seek immediate medical attention if irritation persists.

Ingestion: Drink 1 to 2 glasses of water. Do not induce vomiting. Seek immediate medical attention.

A. GENERAL

1. Check pipes adjacent to cold walls or in unheated spaces. Insulate and tape them if necessary to be sure they can't freeze up.
2. If there is considerable foreign matter in the boiler water, the boiler should be shut down and allowed to cool, then drained and thoroughly flushed out. Drain the boiler at the drain cock. Pipe the drain cock to a suitable drain. Skim and blow down the boiler to remove remaining matter. See Section 1 - PreInstallation for water quality requirements. If there is evidence that hard scale has formed on the internal surfaces, the boiler should be cleaned by chemical means as prescribed by a qualified water treatment specialist.
3. There must be no signs of continuous wetness at the chimney. If signs of continuous wetness are observed, a qualified service agency must be consulted to modify the vent configuration to prevent the formation of condensate, which may damage the vent pipe.

⚠ WARNING

Do not use this appliance if any part has been under water. Improper or dangerous operation may result. Immediately call a qualified service technician to inspect the boiler and to replace any part of the control system and any control which has been under water.

B. DAILY MAINTENANCE (WITH BOILER OPERATING)

Daily boiler observation can be performed by the owner. If any potential problems are found, a qualified installer or service technician/agency must be notified.

1. Remove any combustible materials, gasoline and other flammable liquids and substances that generate flammable vapors from the area where the boiler is contained. Make certain that the boiler area has ample air for combustion and ventilation and that there are no obstructions to the free flow of air to and from the boiler.
2. Observe general boiler conditions (unusual noises, vibrations, etc.)
3. Observe operating pressure gauge on the boiler. Boiler pressure should never be higher than 5 psi below the rating shown on the safety relief valve. The valve rating can be found on the top of the safety relief valve.
4. Check for water leaks in boiler and system piping.

C. MAINTENANCE OF SAFETY RELIEF VALVE

1. Check function and maintain safety relief valve as specified by manufacturer, typically every other month or every month, per the instructions on the tag on the safety relief valve.

D. MONTHLY MAINTENANCE (WITH BOILER OPERATING)

1. Check boiler room floor drains for proper functioning.
2. Test probe type low-water cut-off by using the Push-to-Test Button.
3. Observe operation of boiler through one complete cycle to make sure boiler is controlled as intended.
4. Follow additional instructions in the Burner Manual for proving the burner component operation.

E. MAINTENANCE – ANNUAL

NOTICE

Entire heating system, including boiler, burner and venting system, must be inspected at least once a year by a qualified heating professional. Boiler is to be cleaned at least once a year.

⚠ WARNING

Disconnect all power to the burner before accessing combustion chamber.

TO CLEAN:

1. Remove top jacket panel, flue collector cover plate, Item 11 (Figure 2.1), and flue baffles.
2. To thoroughly clean the boiler it must be brushed down from the top. Alternatively, for limited space or minimum clearance to combustible installations, cleaning the heat exchanger from the combustion chamber side is acceptable. If unit is extremely dirty, it may be necessary to brush from both directions. The target wall is made of a soft ceramic fiber. Care must be taken not to damage this material during cleaning.
3. Remove any scale or soot from the combustion chamber area by vacuum cleaning or any other available means.

NOTICE

Burner mounting plate must be opened to facilitate this operation.

4. Replace oil burner nozzle and filter(s).
5. Re-install flue baffles. When replacing the flue collector cover plate, be certain that the blanket seal between the flue collector cover plate and top section makes a tight seal to prevent leakage of the products of combustion.
6. Replace jacket top panel.

NOTICE

All cover plates, enclosures, and guards must be maintained in place at all times, except during maintenance and servicing.

7. Inspect venting system.

F. IF A LONG SHUTDOWN IS REQUIRED

1. To take boiler out of service if the boiler and system are not to be used when temperatures are below freezing:
 - a. Drain the boiler and system completely and shut off make-up water supply.
 - b. Open main line power disconnect switch to boiler. Remove the fuses or secure the switch so that the power cannot be turned on accidentally.
2. Be certain that the boiler and system are refilled before returning to service.



CAUTION

Always keep the manual fuel supply valve shut off if the burner is shut down for an extended period of time.

7. BOILER DIMENSIONS & RATINGS

Figure 7.1: Boiler Dimensions

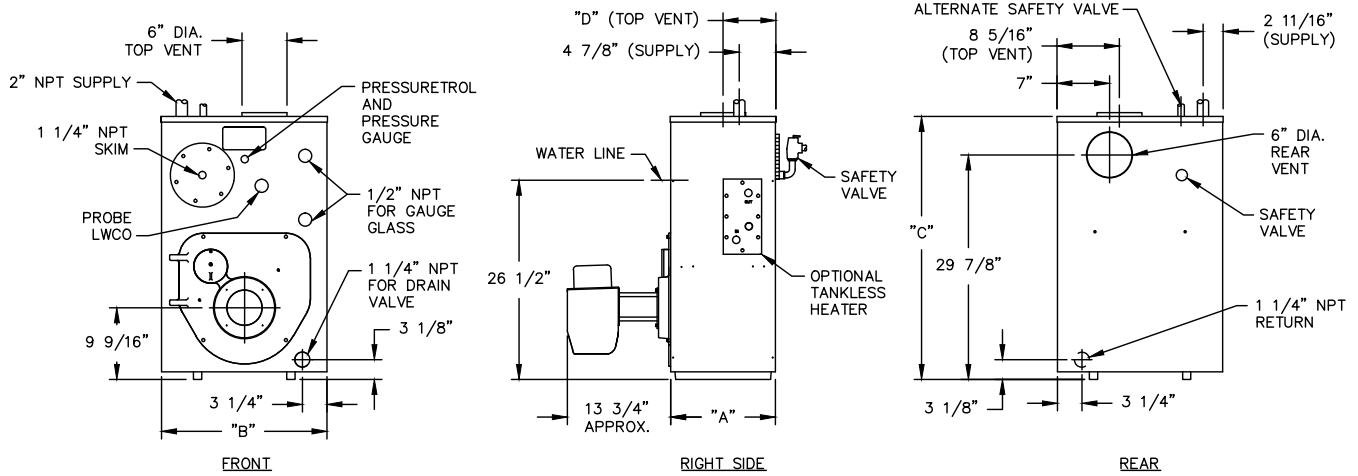

Boiler Model Number	Jacket Depth "A"	Jacket Width "B"	Jacket Height "C"	Rear of Jacket to c/l of Vent "D"
SBO-3085/3105	15-3/4"	22-1/8"	35"	8-7/8"
SBO-4125/4150	19-3/4"	22-1/8"	35"	10-7/8"

Table 7.1: Boiler Ratings

Series SBO							Water Content, gal	Minimum Stack Draft Required, in. W.C.
Boiler Model Number	Input		Heating Capacity ³ , MBH	Net Ratings ²		AFUE, %		
	GPH ¹	MBH	Steam	Steam Sq. Ft.	Steam, MBH	Steam		
SBO-3085	0.85	119	104	325	78	85.6	12.00	-0.04
SBO-3105	1.05	147	127	396	95	85.0	12.00	-0.05
SBO-4125	1.25	175	152	475	114	85.6	14.87	-0.04
SBO-4150	1.50	210	180	563	135	85.0	14.87	-0.05

1 Burner input based on No. 2 fuel oil with a heating value of 140,000 Btu per gallon.
 2 Net steam ratings based on an allowance of 1.333. Additional allowance required when selecting a boiler for installations having unusual piping and pickup requirements, such as intermittent system operation, extensive piping systems, etc.
 3 Heating Capacity and Annual Fuel Utilization Efficiency (AFUE) ratings are based on U.S. Government tests.

Chimney Size: 8" x 8" x 15 ft.

8. REPAIR PARTS

Table 8.1

Item No.*	Description	Additional Information	Stock Code
1	Block Assembly – SBO-3 (Includes 2, 4, 5, 16, 17)	–	SB90707
	Block Assembly – SBO-4 (Includes 2, 3, 4, 5, 16, 17)	–	SB90708
2	Target Wall	–	SB50795
3	Combustion Chamber Blanket Liner SBO-4	–	420001185
4	Swing Door Hinge Kit	–	SB7240
5	Burner Mounting Plate Assembly Kit (Includes Mounting Plate Insulation, Gaskets, Hardware and #6)	–	SB90158
–	Burner Mounting Plate Insulation	–	SB50794
6	Burner Mounting Plate Rope Seal	4.4 Feet	SB51211
9	Tankless Coil Kit with Gasket (17) and Bolts	–	SB90507
–	Tankless Coil Kit with Low Limit Control (L4006A1058) and wiring, Gasket (17) and Bolts	–	550004158
10	Flue Collector Plate Rope Seal	SBO-3 3.8 ft. SBO-4 4.4 ft.	SB51211
11	Flue Collector Plate – SBO-3	–	SB90565
–	Flue Collector Plate – SBO-4	–	SB90566
12	Flue Gasket Seal	–	SBPP5011
13	Top/Rear Flue Outlet Cover Plate	–	SB90563
14	Flue Collar	–	SB90386
15	Jacket Assembly – SBO-3	–	SB91165
	Jacket Assembly – SBO-4	–	SB91166
16	Steel Cover Plate Kit (Rear, Includes Gasket and Hardware)	–	SB90141
17	Rubber Gasket (Rear Section Plate)	–	SB51673
18	Flue Baffle	1 per Flueway	SB51613
–	Pressuretrol (PA404A1009)	–	SS-001.01
–	Drain Valve	–	240009323
–	Pop Safety Valve	–	1570001
–	Steam Pressure Gauge	–	14623006
–	Water Level Gauge Glass (22-209-10 with 7-1/4" Glass)	–	SB50513
–	Syphon	–	14643004
–	Probe Type Low Water Cut-Off (CG450P1560)	–	SB29041
–	Low Limit Operating Control with Control Well (L4006A1058)	–	SB50535
–	Low Limit Wire Harness	–	SB7540
–	Beckett AFG Burner for SBO-3105	–	550004153
–	Beckett AFG Burner for SBO-4150	–	550004154
–	Rerate Kit for SBO-3085	–	550004155
–	Rerate Kit for SBO-4125	–	550004156

Part numbers may be subject to change without notice.

*See Figure 2.1 on page 4 for boiler exploded view.

Series SBO

Oil Steam Boilers

Installation, Operation & Maintenance Manual