

# **PRIWA & PRIWA PLUS ENERWA & ENERWA PLUS**

**CONDENSING COMBI BOILERS  
INSTALLATION, USER & SERVICE MANUAL**



**Our company, constantly striving to improve the products, reserves the right to modify the details given in this documentation at any time and without notice.**



**These Instructions are only meant to provide consumers with use information and under no circumstance should they be construed as a contract with a third party.**



**The appliance can be used by children aged 8 or over and by people with reduced physical, sensory or mental faculties or who do not have the required experience or knowledge, provided they are supervised or have received instructions on using the appliance safely and understanding its intrinsic hazards. Children must not play with the appliance. The cleaning and maintenance operations reserved to the user must not be performed by unsupervised children.**

# CONTENTS

<b>1. GENERAL</b> .....	9	4.6 Silencer Assembly - Premix 24 Kw Boilers .....	66
1.1 Introduction .....	12	4.7 Check Boiler Combustion & Calibration Values .....	67
1.2 Operation .....	12	4.8 Check Boiler Combustion & Calibration Values .....	68
1.3 Safe Handling .....	12	4.9 Check Boiler Combustion & Calibration Values .....	69
1.4 Optional Extra Kits .....	12	4.10 Check Boiler Combustion & Calibration Values .....	70
1.5 Safety .....	12	4.11 Priwa / Enerwa Wall-Hung Boilers Serviceman Mode .....	71
1.6 Safe Handling Of Substances .....	13	4.12 Priwa Plus / Enerwa Plus Wall-Hung Boilers Serviceman Mode .....	72
1.7 Location Of Boiler .....	13	4.13 Priwa / Enerwa Wall-Hung Boilers Manuel Calibration .....	73
1.8 Gas Supply .....	13	4.14 Priwa Plus / Enerwa Plus Wall-Hung Boilers Manuel Calibration .....	75
1.9 Water Circulation System .....	14	4.15 Priwa / Enerwa Wall-Hung Boilers Auto Calibration .....	76
1.10 Boiler Control Interlocks .....	14	4.16 Priwa Plus / Enerwa Plus Wall-Hung Boilers Auto Calibration .....	77
1.11 Electrical Supply .....	14	4.17 Priwa / Enerwa Wall-Hung Boilers Eeprom Reset .....	78
1.12 Condensate Drain .....	14	4.18 Priwa Plus / Enerwa Plus Wall-Hung Boilers Eeprom Reset .....	79
1.13 Boiler Dimensions, Services & Clearances .....	14	4.19 Lawa / Priwa / Enerwa Wall-Hung Boilers Info Menu .....	80
1.14 System Requirements .....	15	4.20 Lawa / Priwa / Enerwa Wall-Hung Boilers Info Menu .....	82
1.15 System Balancing .....	16	4.21 Lawa / Priwa / Enerwa Wall-Hung Boilers Deaeration Mode .....	84
1.16 See Section .....	16	4.22 Lawa Plus / Priwa Plus / Enerwa Plus 24-28-33 Wall-Hung Boilers Deaeration Mode .....	85
<b>2. INSTALLATION PERSONNEL SECTION</b> .....	17	4.23 Lawa / Priwa / Enerwa Wall-Hung Boilers DhW Preheat Mode .....	86
2.1 Contents Of Packing Box .....	18	4.24 Lawa Plus / Priwa Plus / Enerwa Plus Wall-Hung Boilers DHW Preheat Mode .....	88
2.2 Flue System .....	18	4.24.1 Lawa Plus 24-28 / Priwa Plus 24-28-33 / Enerwa Plus 24-28-33 Wall-Hung Boilers DHW Preheat Mode Short Cut .....	
2.3 Maximum Lengths .....	19	4.25 Lawa / Priwa / Enerwa Wall-Hung Boilers On-Off Mode .....	90
2.4 Slope .....	20	4.26 Lawa Plus / Priwa Plus / Enerwa Plus Wall-Hung Boilers On-Off Mode .....	91
2.5 Flue Termination Position .....	21	4.27 All Wall-Hung Boilers SGV Gas Valve Electrical Resistance .....	92
2.6 Installing The Boiler .....	22	4.28 All Wall-Hung Boilers Return NTC Electrical Resistance .....	93
2.7 Mounting The Boiler .....	22	4.29 All Wall-Hung Boilers Flow & Limit Thermostat NTC Electrical Resistance .....	94
2.8 Assembly Practice .....	22	4.30 All Wall-Hung Boilers Hot Water NTC Electrical Resistance .....	95
2.9 Installation With Horizontal Flue Sets .....	23	4.31 All Wall-Hung Boilers Gas NTC Electrical Resistance .....	96
2.10 Installation With Vertical Flue Sets .....	24	4.32 Priwa / Enerwa Wall-Hung Boilers Gas Conversation From NG (G20) To LPG (G31) .....	97
2.11 Separator Kit Ø 80/80 (Hermetic) Flue Type Use .....	25	4.33 Priwa Plus / Enerwa Plus Wall-Hung Boilers Gas Conversation From NG (G20) To LPG (G31) .....	98
2.12 Condensate .....	26	4.34 Priwa / Enerwa Wall-Hung Boilers Gas Conversation From LPG (G31) To NG (G20) .....	99
2.13 Connections & Filling .....	28	4.35 Priwa Plus / Enerwa Plus Wall-Hung Boilers Gas Conversation From LPG (G31) To NG (G20) .....	100
2.14 Electrical Connections .....	30	4.36 All Wall-Hung Boilers Max CH Power Adjustment Via P06 - P08 .....	101
2.15 Internal Wiring .....	30	4.37 Technical Datas .....	102
2.16 CH Operation .....	31	4.38 Handling Over .....	104
2.17 The Weather Compensation Kit .....	31	4.39 Servicing Schedule .....	104
2.18 Commissioning And Testing .....	32	4.40 Burner Removal And Cleaning .....	105
<b>3. USER'S SECTION</b> .....	35	4.41 Cleaning The Condensate Trap/Siphon .....	106
3.1 General Warnings For User .....	36	4.42 Cleaning The Heat Exchanger .....	106
3.2 Control Panel Of Priwa And Enerwa Model Combi Devices .....	37	4.43 Reassembly .....	106
3.3 Selection Of On/Off/Standby And Summer/Winter Modes .....	38	4.44 Replacement Of Components .....	106
3.3.1 On/Off/Standby Positions .....		4.45 Fan Replacement .....	107
3.3.2 Operation At Winter Position .....		4.46 Burner Injector Replacement .....	108
3.3.3 Operation At Summer Position .....		4.47 Burner Replacement .....	108
3.3.4 Resetting The Combi (Re-Starting) .....		4.48 Flow And Return Thermistors Renewal .....	109
3.3.5 Shutting Off The Combi .....		4.49 Flue Thermistor Replacement .....	109
3.3.6 Selection Of On/Off/Standby And Summer/Winter Modes .....		4.50 Ignition Electrode Replacement .....	110
3.4 Control Panel Of Priwa Plus & Enerwa Plus Combi .....	39	4.51 Gas Control Valve Replacement .....	110
3.4.1 Buttons And Pushbuttons .....		4.52 Diverter Valve Actuator Replacement .....	111
3.4.2 Position Explanations .....		4.53 Condensate Trap/Siphon Replacement .....	111
3.4.3 Selection Of On/Off/Standby And Summer/Winter Modes .....		4.54 Main PCB Replacement .....	111
3.4.4 On/Off/Standby Positions .....		4.55 User Control PCB Replacement (Plus) Models .....	112
3.4.5 Operation At Winter Position .....		4.56 DHW Flow Turbine Sensor Replacement .....	112
3.4.6 Operation At Summer Position .....		4.57 Draining The Boiler .....	112
3.4.7 Shutting Off The Combi .....		4.58 Pressure Gauge Renewal .....	113
3.5 Use With Room Thermostat (Optional) .....	41	4.59 Safety Relief Valve Renewal .....	113
3.6 External Weather Temperature Sensor Use (Optional) .....	42	4.60 Pump Automatic Air Vent Replacement .....	113
3.7 Customizing Combi Features .....	42	4.61 DhW Flow Turbine Cartridge Replacement .....	114
3.8 Troubleshooting .....	43	4.62 Diverter Valve Internal Cartridge Replacement .....	114
3.9 Recommendations For Economical Use Of Combi .....	45	4.63 DhW Plate Heat Exchanger Replacement .....	115
3.10 Issues Required To Be Taken Into Consideration For Warranty Conditions .....	46	4.64 Pump Head Replacement .....	115
3.11 Issues Required To Be Taken Into Consideration For Warranty Conditions .....	46	4.65 CH Water Pressure Sensor Replacement .....	116
<b>4. TECHNICIAN &amp; SERVICING</b> .....	47	4.66 DHW Filter Cleaning / Replacement .....	116
4.1 Parts Comprising The Combi .....	48	4.67 Heat Engine Renewal .....	117
4.2 Boiler Front Panel Removal / Replacement .....	48	4.68 Expansion Vessel Recharging & Replacement .....	117
4.3 Set Transparent Parameters Menu (Tsp) .....	49	4.69 Boiler Sealing Panel Replacement Seal Replacement .....	117
4.4 Parameters List .....	52	4.70 Electrode Positioning For 24 Kw .....	118
4.5 Wiring Diagrams .....	58	4.71 Electrode Positioning For 28 Kw And 33 Kw .....	119
4.5.1 Priwa 24 Wiring Diagrams .....			
4.5.2 Priwa 28 / Priwa 33 Wiring Diagrams .....			
4.5.3 Priwa Plus 24 Wiring Diagrams .....			
4.5.4 Priwa Plus 28 / Priwa Plus 33 Wiring Diagrams .....			
4.5.5 Enerwa 24 / Enerwa 2530 C .....			
4.5.6 Enerwa 28 / Enerwa 33 / Enerwa 3035 / Enerwa 3540 C .....			
4.5.7 Enerwa Plus 24 / Enerwa Plus 2530 C .....			
4.5.8 Enerwa Plus 28 / Enerwa Plus 33 / Enerwa Plus 3035 / Enerwa Plus 3540 C .....			

## Boiler Gas Categories & Destinations

Designation: Used gas types & Countries

Object Manufacturer		Type-model / Technical data		Mark (s) of conformity				
Boiler gas categories & destinations		Warmhaus all wall-hung boilers		granted				
Gas categories for Warmhaus boilers has been applied on CE certification on SZU Test / BRNO given below; - the appliance category(ies) in relation to the direct countries of destination has been specified EN 15502-1 - the country(-ies) of destination, in accordance with EN ISO 3166-1; - the gas supply pressure in millibars, if several normal pressures can be used for the same gas group. They are indicated by their numerical value and the unit "mbar"								
Document for conformity approved by SZU test	Appliance Categories	Gas Type	Gas Inlet Supply Pressures	Used Gas	Lawa 24 Lawa Plus 24 Lawa 28 Lawa Plus 28	Priwa 24 Priwa Plus 24 Priwa 28 Priwa Plus 28 Priwa 33 Priwa Plus 33	Enerwa 24 Enerwa Plus24 Enerwa 28 Enerwa Plus 28 Enerwa 33 Enerwa Plus 33	Countries of Destination **
YES	I 2H	Natural Gas	20 mbar	G20	Available	Available	Available	AT, BG, CH, CZ, DK, EE, ES, FI, GB, GR, IE, IT, LT, LV, NO, PT, RO, SE, SI, SK
YES	I 2H	Natural Gas	25 mbar	G20	Not Available	Available	Available	HU
YES	I 2E	Natural Gas	20 mbar	G20	Available	Available	Available	DE, LU, PL, RO
YES	I 2E+	Natural Gas	20 mbar	G20	Not Available	Available	Available	BE, FR
YES	I 2E+	Natural Gas	25 mbar	G25	Not Available	Available	Available	BE, FR
YES	I 2L	Natural Gas	25 mbar	G25	Not Available	Available	Available	NL
YES	I 2ELL	Natural Gas	20 mbar	G20	Not Available	Available	Available	DE
YES	I 2ELL	Natural Gas	20 mbar	G25	Not Available	Available	Available	DE
YES	II 2H3P	Natural Gas	20 mbar	G20	Available	Not Available	Not Available	CH, CZ, ES, FR, GB, GR, IE, RO, SI, SK
YES	II 2H3P	ProphaneLPG	37 mbar	G31	Available	Not Available	Not Available	CH, CZ, ES, FR, GB, GR, HR, IE, IT, LT, PT, RO, SI, SK
YES	I 3P	ProphaneLPG	37 mbar	G31	Available	Available	Available	BE, CH, CZ, ES, FR, GB, GR, HR, IE, IT, LT, NL, PL, PT, RO, SI, SK, TR

\*\* EN ISO 3166-1:2006, Codes for the representation of names of countries and their subdivisions – Part 1: Country codes (ISO 3166-1:2006)

Author: İsmail B. Taşdemir / R&D Mng.

Release date: 4/20/2017

Rev. No: 0

Drw. No: WH.17.107

As this is the property of Warmhaus Isıtma ve Sogutma Sistemleri San. Tic. A.Ş. It must not be passed on to any person not authorized by Warmhaus Isıtma ve Sogutma Sistemleri San. Tic. A.Ş or be copied or otherwise utilized by anybody without expressed written permission.

Table 1.1

Product Name (as on product data badge & installation instructions)	G.C. No Allocated by British Gas**
Enerwa 2530	47-786-01
Enerwa Plus 2530	47-786-02
Enerwa 3035	47-786-03
Enerwa Plus 3035	47-786-04
Enerwa 3540	47-786-05
Enerwa Plus 3540	47-786-06

Table 1.2

Product FICHE & ErP Data											
		Manufacturer		Type-model / Technical data		Mark (s) of conformity granted					
ErP Data		Warmhaus		Enerwa / Enerwa Plus boilers							
ErP & Product Fiche for Warmhaus boilers has been tested and reported on SZU Test / BRNO given below;											
<b>PRODUCT FICHE (according to EU regulation No 811/2013 and 814/2013)</b>											
		Enerwa 24 Enerwa Plus 24		Enerwa 24 Enerwa Plus 24		Enerwa 28 Enerwa Plus 28		Enerwa 33 Enerwa Plus 33		Enerwa 33 Enerwa Plus 33	
		2530 C		2530 C		3035 C		3540 C		3540 C	
Space heating - Temperature application				High / Medium / Low		High / Medium / Low		High / Medium / Low		High / Medium / Low	
Water heating - Declared load profile				L		XL		XL		XXL	
Seasonal space heating energy efficiency class				A		A		A		A	
Water heating energy efficiency class				A		A		A		B	
Rated heat output (Prated or Psup)		kW		24		24		28		33	
Space heating - annual energy consumption		Q <sub>HE</sub> GJ		42,14		42,14		48,77		54,78	
Water heating - Annual energy consumption		kWh (*)		26		37		34		39	
		GJ (**)		11		18		18		23	
Seasonal space heating energy efficiency		%		91		91		91		91	
Water heating energy efficiency		%		81		84		83		84	
Sound power level LWA indoors		dB		52		52		54		50	
Option to only operate during low demand periods		-		-		-		-		-	
Specific precautions for assembly, installation and maintenance				Before any assembly, installation or maintenance the user and installation manual has to be read attentively and to be followed							
All the data that is included in the product information was determined by applying the specifications of the relevant European directives. Differences to product information listed elsewhere may result in different test conditions. Only the data that is contained in this product information is applicable and valid.											
(*) Electricity											
(**) Fuel											

Table 1.3

Our company declares that these products (CE) are marked in compliance with the essential requirements of the following

**Directives:**

- Gas Directive **2009/142/EC**
- Boiler Efficiency **92/42/EEC**
- Electromagnetic Compatibility Directive **2014/30/EU**
- Low Voltage Directive **2014/35/EU**
- Directive Ecodesign **2009/125/EC**
- Regulation (EU) No **811/2013 - 814/2013**



ErP DATA (according to EU regulation No 813/2013 and 814/2013)							
			Enerwa 24 Enerwa Plus 24	Enerwa 24 Enerwa Plus 24	Enerwa 28 Enerwa Plus 28	Enerwa 33 Enerwa Plus 33	Enerwa 33 Enerwa Plus 33
			2530 C	2530 C	3035 C	3540 C	3540 C
Water heating - Declared load profile			L	XL	XL	XL	XL
Rated Heat Output	Prated	kW	24	24	28	33	33
Useful heat output at rated heat output and high temperature regime (2)	P <sub>4</sub>	kW	23.7	24	28	33	33
Useful heat output at 30% of rated heat output and low temperature regime (1)	P <sub>1</sub>	kW	4.34	4.34	4.97	5.86	5.86
<b>Seasonal Space Heating Energy Efficiency</b>	η <sub>s</sub>	%	91	91	91	91	91
Useful efficiency at rated heat output and high temperature regime(2)	η <sub>4</sub>	%	88.24	88.24	88.12	88.40	88.40
Useful efficiency at 30% of rated heat output and low temperature regime(1)	η <sub>1</sub>	%	98.20	98.20	96.82	96.70	96.70
<b>Auxiliary Electricity Consumption</b>							
Full load	elmax	kW	0.70	0.70	0.70	0.70	0.70
Part load	elmin	kW	0.30	0.30	0.35	0.46	0.46
Standby mode	P <sub>SB</sub>	kW	0.005	0.005	0.005	0.005	0.005
<b>Other Items</b>							
Standby heat loss	P <sub>Siby</sub>	kW	0.057	0.057	0.057	0.057	0.057
Ignition burner power consumption	P <sub>ign</sub>	kW	0.000	0.000	0.000	0.000	0.000
Space heating - annual energy consumption	Q <sub>HE</sub>	GJ	42.14	42.14	48.77	54.78	54.78
Sound power level, indoors	L <sub>WA</sub>	dB	52	52	54	50	50
Emissions of nitrogen oxides	NO <sub>x</sub>	mg/kWh	20	20	41	34	34
<b>Domestic Hot Water Parameters</b>							
<b>Declared Load Profile</b>			L	XL	XL	XL	XXL
Daily electricity consumption	Q <sub>elec</sub>	kWh	0.117	0.169	0.157	0.177	0.190
Annual electricity consumption*	AEC	kWh	26	37	34	39	42
Water Heating Energy Efficiency	h <sub>wh</sub>	%	81	84	83	84	82
Daily fuel consumption	Q <sub>fuel</sub>	kWh	14.809	23.152	23.615	23.078	29.317
Annual fuel consumption	AFC	GJ	11	18	18	18	23
Condensing boiler	-		Yes	Yes	Yes	Yes	Yes
Low temperature boiler	-		Yes	Yes	Yes	Yes	Yes
Combination boiler	-		Yes	Yes	Yes	Yes	Yes
B1 Boiler	-		No	No	No	No	No
Room boiler with combined heat and power	-		No	No	No	No	No
Auxiliary boiler	-		No	No	No	No	No
Brand Name	Warmhaus						
Manufacturer adress	Warmhaus Isıtma ve Sogutma Sistemleri San. Tic. A.Ş. Nilufer Organize Sanayi Bolgesi Selvi Cad. No:3 Nilufer/Bursa/Turkey						
Warnings 	All specific precautions for assembly, installation and maintenance are described in the operating and installation manual. Read and follow the operating and installation manual.						
	Read and follow the operating and installation manual regarding assembly, installation, maintenance, removal, recycling and/or disposal.						
* for average climatic conditions							
(1) Low temperature means for condensing boilers 30 °C, for low temperature boilers 37 °C and for other heaters 50 °C return temperature (at heater inlet).							
(2) High temperature regime means 60 °C return temperature at heater inlet and 80 °C feed temperature at heater outlet.							
Author: İsmail B. Taşdemir / R&D Mng. Release date: 26/04/17 Rev. No: 0 Drw. No: WH.17.128				As this is the property of Warmhaus Isıtma ve Sogutma Sistemleri San. Tic. A.Ş. It must not be passed on to any person not authorized by Warmhaus Isıtma ve Sogutma Sistemleri San. Tic. A.Ş or be copied or otherwise utilized by anybody without expressed written permission.			

Table 1.4

PRODUCT FICHE

Seasonal Space Heating Energy Efficiency of the Boiler								%	A
Temperature control (from fiche of temperature control)									
Class I	Class II	Class III	Class IV	Class V	Class VI	Class VII	Class VIII	%	B
1%	2%	1.5%	2%	3%	4%	3.5%	5%		

Table 1.5

Solar Contribution (from fiche of solar device)

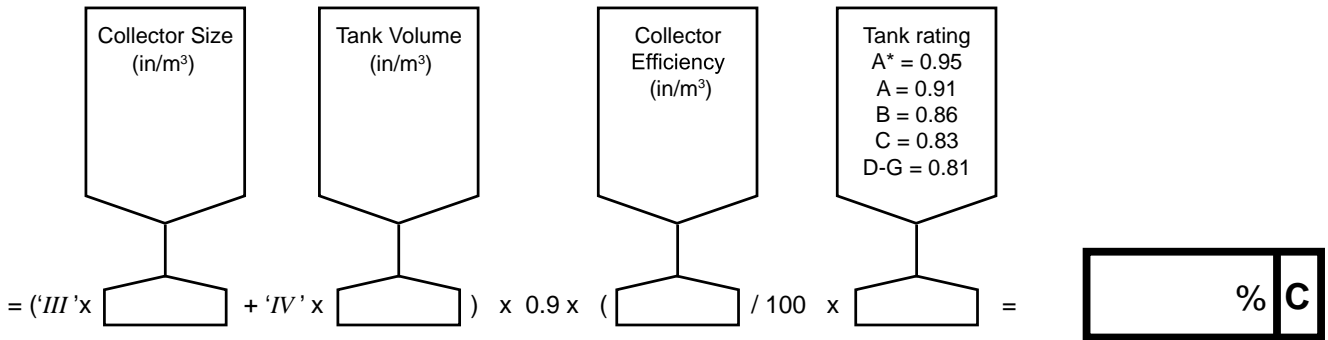

Seasonal Space Heating Energy Efficiency of Package

TOTAL: A+B+C=

%

Seasonal Space Heating Energy Efficiency Class of Package

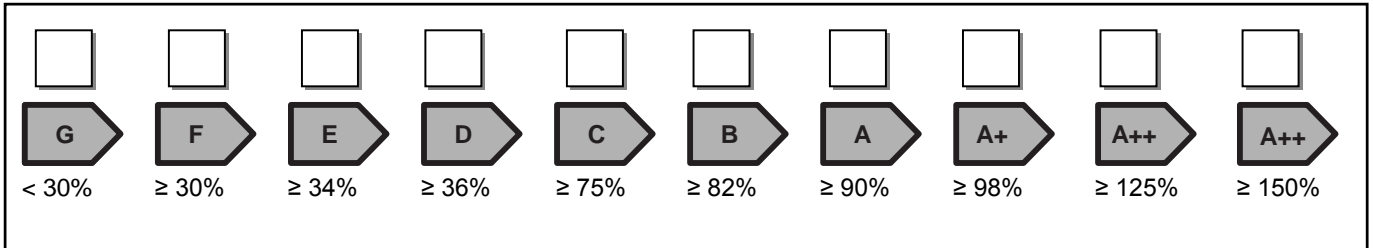

The energy efficiency of the package of products provided for in this document may not correspond to its actual energy efficiency once installed in a building, as the efficiency is influenced by further factors such as heat loss in the products in relation to the building size and its characteristics.

## NOTES FOR THE INSTALLER

**FOR ANY TECHNICAL QUERIES PLEASE RING THE  
WARMHAUS CONSUMER / INSTALLER / TECHNICAL HELPLINE:**

NOTE: BOILER RESTART PROCEDURE -  
Press the RESTART button. The boiler will repeat the  
ignition sequence if a heat demand is present.

**01234 510 010**  
Consumer Helpline

**01234 510 020**  
Technical Helpline

## DOCUMENT AMENDMENTS

Relevant Installation changes implemented in this book from Mod Level.....A01 (July 2017)

Warmhaus reserve the right to vary specification without notice



# SECTION 1 GENERAL

---

Priwa & Enerwa  
Priwa Plus & Enerwa Plus



GENERAL DATA	UNIT	MODEL		
		Enerwa 24 / Enerwa Plus 24	Enerwa 28 / Enerwa Plus 28	Enerwa 33 / Enerwa Plus 33
		2530 C	3035 C	3540 C
		24/31	28/35	33/40
Gas Supply		2H - G20 - 20mbar		
Gas Supply Connection		3/4" thread		
Injector Size	mm	5.6	6.0	6.3
Inlet Connection	DHW	1/2" thread		
Outlet Connection	DHW	1/2" thread		
Flow Connection	CH	3/4" thread		
Return Connection	CH	3/4" thread		
Flue Terminal Diameter	mm (in)	60 (nominal)		
Average Flue Temp-Mass Flow Rate	(DHW)	70°C - 14.01 g/s	70°C - 15.53g/s	73°C - 18.36g/s
Maximum Working Pressure (Sealed Systems)	bar (lb/in2)	2.5 (36.3)		
Maximum Domestic Hot Water Inlet Pressure	bar (lb/in2) (kPa)	10.0 (145) (1000)		
Minimum Domestic Hot Water Inlet Pressure*	bar (lb/in2) (kPa)	1.1 (15.95) (130)	1.1 (15.95)** (130)	1.1 (15.95)** (130)
Minimum DHW Inlet Pressure to operate at 0.5 bar system pressure	bar	0.5		
Electrical Supply		230 V ~ 50 Hz.		
Power Consumption	w	95/55	104/60	115/65
On Board Protection Fuse		3.15 AF (Rapid) Max. 250 VAC d5x20		
Water Content CH	litre (gal)	24 kW: CH: 1.41 L (0.31)	28 kW: CH: 1.65 L (0.36)	33 kW: CH: 1.98 L (0.44)
DHW	litre (gal)	24 kW: DHW: 0.111 L (0.024)	28kW: DHW: 0.132L(0.029)	33 kW: DHW: 0.166 L (0.037)
Packaged Weight	kg	34.7	35.9	63.7
Maximum Installation Weight	kg	34.0	35.5	36.6
Boiler Casing Size Height	mm	725		
Width	mm	420		
Depth	mm	288		

Table 1.6

\*Required for maximum flow rate. Boiler operates down to 1.5 l/min DHW delivery \*\* In areas of low water pressure the DHW restrictor can be added

TECHNICAL DATA	UNIT	MODEL								
		Enerwa 24 / Enerwa Plus 24 / 2530 C			Enerwa 28 / Enerwa Plus 28 / 3035 C			Enerwa 33 / Enerwa Plus 33 / 3540 C		
Gas Type		G20	G25	G31	G20	G25	G31	G20	G25	G31
Gas Supply Pressure	mbar	20	25	37	20	25	37	20	25	37
Gas Consumption at Maximum	m <sup>3</sup> /h	2.38*	2.85	0.92	3.05*	3.47	1.18	3.402	4.127	1.302
Gas Consumption at Maximum	ft <sup>3</sup> /h	84.05*	100.65	32.5	107.7*	122.6	41.7	120.1	145.7	46
Gas Consumption at Minimum	m <sup>3</sup> /h	0.37*	0.43	0.11	0.397*	0.456	0.144	0.434	0.524	0.168
Gas Consumption at Minimum	ft <sup>3</sup> /h	13*	15.2	3.9	14*	16.1	5.09	15.3	18.5	5.9
*(Natural Gas G20) Heat Load (Hu=10,56 kWh/m <sup>3</sup> )										
Efficiency		G20	G25	G31	G20	G25	G31	G20	G25	G31
(80/60 °C) Efficiency at Maximum Heat Output	%	98.03	97.84	97.76	97.88	98.15	98.59	98.00	98.23	98.04
(50/30 °C) Efficiency at Maximum Heat Output	%	105.11	105.34	103.63	105.0	104.26	104.67	105.4	105.53	105.43
Efficiency at 30% load at 36/30 °C	%	108.29	108.38	108.29	107.54	107.83	107.36	107.2	107.06	106.98
Seasonal space heating energy efficiency (expressed in terms of GCV)	%	91 (Class A)			91 (Class A)			91 (Class A)		
Radiator Circuit		G20	G25	G31	G20	G25	G31	G20	G25	G31
Maximum Heat Input Qn	kW	24.25	24.25	24.25	28.7	29	29.4	33.7	33.7	33.7
Maximum Heat Output Pn (80/60 °C)	kW	23.7	23.7	23.7	28	28	28.01	33.02	33.02	33.02
Maximum Heat Output Pn (50/30 °C)	kW	25	25	25	30	30	28.63	35.5	35.5	35.5
NOx	Class	5			5			5		

Table 1.7

DOMESTIC HOT WATER CIRCUIT	UNIT	MODEL		
		Enerwa 24 / Enerwa Plus 24 / 2530 C	Enerwa 28 / Enerwa Plus 28 / 3035 C	Enerwa 33 / Enerwa Plus 33 / 3540 C
Maximum DHW Heat Input	kW	31.15		38.8
Minimum DHW Heat Input	kW	3.5		4.35
Max. Domestic Hot Water flow rate (Δt: 30 °C)	ℓ/min.	14.8		19.00
Max. Domestic Hot Water flow rate (Δt: 30 °C)	gpm	3.3		4.2
Maximum Water Pressure	bar	10		10
Minimum Water Pressure	bar	0.5		0.5

Table 1.8

\* The value is used in the UK Government's Standard Assessment Procedure (SAP) for energy rating of dwellings. The test data from which it has been calculated have been certified by a notified body.

**Note:** Gas consumption is calculated using a calorific value of 38.7 MJ/m<sup>3</sup> (1038 Btu/ft<sup>3</sup>) gross or 34.9 MJ/m<sup>3</sup> (935 Btu/ft<sup>3</sup>) nett

To obtain the gas consumption at a different calorific value:

- For l/s - divide the gross heat input (kW) by the gross C.V. of the gas (MJ/m<sup>3</sup>)
- For Btu/h - multiply the gross heat input (kW) by 26.8
- For ft<sup>3</sup>/h - divide the gross heat input (Btu/h) by the gross C.V. of the gas (Btu/ft<sup>3</sup>)
- For m<sup>3</sup>/h - multiply l/s by 3.6

#### Key to symbols

**GB** = United Kingdom

**IE** = Ireland (Countries of destination)

**PMS** = Maximum operating pressure of water

**C13 C33 C53 C63 C83** = A room sealed appliance designed for connection via ducts to a horizontal or vertical terminal, which admits

fresh air to the burner and discharges the products of combustion to the outside through orifices which, in this case, are concentric. The fan is up stream of the combustion chamber.

I<sub>2H</sub> = An appliance designed for use on 2nd Family gas, Group H only.

I<sub>3P</sub> = An appliance designed for use on 3rd Family gas, Group P only.

**WARMHAUS COMBI  
2530 C, 3035 C & 3540 C  
Natural Gas only**

Boiler size	G.C. Appliance No. (Benchmark No.)	PI No.
Enerwa 24 / Enerwa Plus 24 2530 C		
Enerwa 28 / Enerwa Plus 28 3035 C		
Enerwa 33 / Enerwa Plus 33 3540 C		

Table 1.7

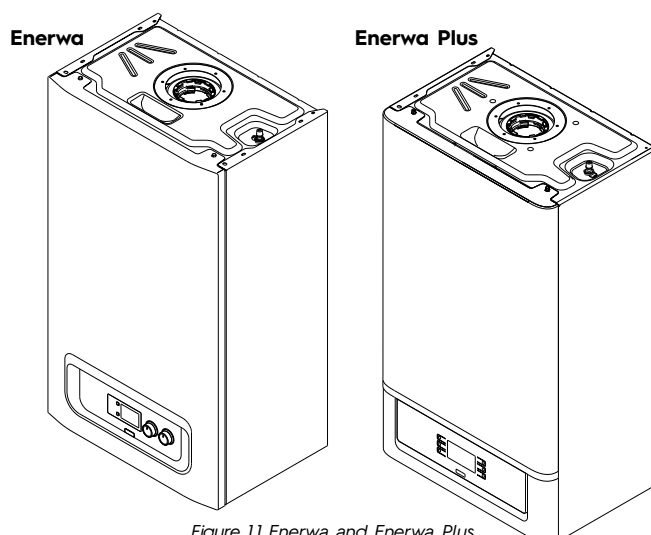

Figure 1.1 Enerwa and Enerwa Plus

Appliance categories	Supply pressures [mbar]	Used gas	Countries of destination	Enerwa 24 / Enerwa Plus 24	Enerwa 28 / Enerwa Plus 28	Enerwa 33 / Enerwa Plus 33
				2530 C	3035 C	3540 C
I <sub>2H</sub>	20	G20	AT, BG, CH, CZ, DK, EE, ES, FI, GB, GR, IE, IT, LT, LV, NO, PT, RO, SE, SI, SK		Yes	
I <sub>2E</sub>	20	G20	DE, LU, PL, RO		Yes	
I <sub>2E+</sub>	20/25	G25	BE, FR		Yes	
I <sub>2L</sub>	25	G25	NL		Yes	
I <sub>2ELL</sub>	20, 20	G20, G25	DE		Yes	
I <sub>2H</sub>	25	G20	HU		Yes	
I <sub>3P</sub>	37	G31	CH, CZ, ES, GB, GR, IE, RO, SI, SK, BE, FR, IT, LT, NL, PL, PT		Yes	
NUMBER OF CHOSED CONNECTING CONDITIONS						

Table 1.10

For GB, to comply with Building Regulations Part L1 (Part 6 in Scotland) the boiler should be fitted in accordance with the manufacturer's instructions. Self-certification that the boiler has been installed to comply with Building Regulations can be demonstrated by completing and signing the Benchmark Commissioning Checklist.

Before installing this boiler, read the Code of Practice sheet at the rear of this book.

#### BENCHMARK COMMISSIONING CHECKLIST DETAILS

Boiler	Page		Page
Make and model .....	11	Burner operating pressure .....	n/a
Appliance serial no. on data badge .....	Front Cover	Central heating flow temp. ....	measure and record
SEDBUK No. % .....	10	Central heating return temp. ....	measure and record
<b>Controls</b>		<b>For combination boilers only</b>	
Time and temperature control to heating .....	28-29	Scale reducer .....	15
Heating zone valves .....	n/a	<i>Hot water mode</i>	
TRV's .....	14	Heat input .....	to be calculated
Auto bypass .....	14	Max. operating burner pressure .....	n/a
Boiler interlock .....	14	Max. operating water pressure .....	measure & record
<b>For</b> .....	<b>all boilers</b>	Cold water inlet temp. ....	measure & record
Flushing to BS.7593 .....	15	Hot water outlet temp. ....	measure & record
Inhibitor .....	16	Water flow rate at max. setting .....	measure & record
<i>Central heating mode</i>		<b>For condensing boilers only</b>	
Heat input .....	to be calculated	Condensate drain .....	26-27
		<b>For all boilers:</b> .....	complete, sign & hand over to customer

For assistance see Technical Helpline on the back page

**NOTE TO THE INSTALLER: COMPLETE  
THE BENCHMARK COMMISSIONING  
CHECKLIST AND LEAVE THESE  
INSTRUCTIONS WITH APPLIANCE**



## 1.1 Introduction

The Warmhaus Combi boiler is a wall mounted, full sequence, automatic spark ignition, low water content, fanned flue, high efficiency, condensing and gas adaptive combination gas boiler.

**Note:** Due to the high efficiency of the boiler a plume of water vapour will form at the terminal during operation.

Central heating (CH) output is fully modulating with a range of:

<b>Enerwa 24/Enerwa Plus 24 - 2530 C</b>	<b>24/31</b>	<b>3.1 to 23.7 kW</b>
<b>Enerwa 28/Enerwa Plus 28 - 3035 C</b>	<b>28/35</b>	<b>3.5 to 28 kW</b>
<b>Enerwa 33/Enerwa Plus 33 - 3540 C</b>	<b>33/40</b>	<b>4.0 to 33 kW</b>

Instantaneous domestic hot water (DHW) output is also fully modulating with a maximum of:

<b>Enerwa 24/Enerwa Plus 24 - 2530 C</b>	<b>24/31</b>	<b>3.1 to 31.15 kW</b>
<b>Enerwa 28/Enerwa Plus 28 - 3035 C</b>	<b>28/35</b>	<b>3.5 to 35 kW</b>
<b>Enerwa 33/Enerwa Plus 33 - 3540 C</b>	<b>33/40</b>	<b>4.0 to 38.8 kW</b>

The boiler is supplied fully assembled with DHW plate heat exchanger, diverter valve, circulating pump, pressure gauge, safety valve and CH expansion vessel.

Variable CH and DHW temperature controls are fitted on the user control and the boiler features a DHW preheat facility.

The boiler includes as standard:

- Automatic bypass
- Boiler frost protection
- Daily pump and diverter valve exercise

The boiler casing is of white painted mild steel with polymer front panel.

The boiler temperature controls are visible located in the control panel on the front of the boiler.

The heat exchanger is manufactured from stainless steel.

The boiler is suitable for connection to fully pumped, sealed heating systems ONLY. Adequate arrangements for completely draining the system by provision of drain cocks MUST be provided in the installation pipework.

Pipework from the boiler is routed downwards.

### Data Plate

The boiler model and serial number can be located on the bottom of the boiler casing, shown in Frame 1 - Water & Gas Connection Diagram.

## 1.2 Operation

With no demand for CH, the boiler fires only when DHW is drawn off, or periodically for a few seconds without any DHW draw-off, in order to maintain the DHW in a heated condition. This only occurs if pre-heat activated via parameters.

When there is a demand for CH, the heating system is supplied at the selected temperature of between 25°C and 80°C, until DHW is drawn off. The full output from the boiler is then directed via the diverter valve to the plate heat exchanger to supply a nominal DHW draw-off of:

2530 C	24/31	14.8 l/min at 30 °C temperature rise.
3035 C	28/35	16.08 l/min at 35 °C temperature rise.
3540 C	33/40	19.00 l/min at 35 °C temperature rise

When using the outside sensor provided please refer to page 42. At low DHW draw-off rates the maximum temperature may exceed 65°C.

The boiler features a comprehensive diagnostic system which gives

detailed information on the boiler status when operating, and performance of key components to aid commissioning and fault finding.

## 1.3 Safe Handling

This boiler may require 2 or more operatives to move it to its installation site, remove it from its packaging base and during movement into its installation location. Manoeuvring the boiler may include the use of a sack truck and involve lifting, pushing and pulling. Caution should be exercised during these operations.

Operatives should be knowledgeable in handling techniques when performing these tasks and the following precautions should be considered:

- Grip the boiler at the base.
- Be physically capable.
- Use personal protective equipment as appropriate, e.g. gloves, safety footwear.

During all manoeuvres and handling actions, every attempt should be made to ensure the following unless unavoidable and/or the weight is light.

- Keep back straight.
- Avoid twisting at the waist.
- Avoid upper body/top heavy bending.
- Always grip with the palm of the hand.
- Use designated hand holds.
- Keep load as close to the body as possible.
- Always use assistance if required.

## 1.4 Optional Extra Kits

Please visit [www.warmhaus.com](http://www.warmhaus.com) to access the Flue and Accessories Guide for this boiler.

## 1.5 Safety

### Current Gas Safety (installation and use) regulations or rules in force:

The appliance is suitable only for installation in GB and IE and should be installed in accordance with the rules in force.

In GB, the installation must be carried out by a Gas Safe Registered Engineer. It must be carried out in accordance with the relevant requirements of the:

- Gas Safety (Installation and Use) Regulations.
- The appropriate Building Regulations either The Building Regulations, The Building Regulations (Scotland), Building Regulations (Northern Ireland).
- The Water Fittings Regulations or Water byelaws in Scotland.
- The Current I.E.E. Wiring Regulations.

Where no specific instructions are given, reference should be made to the relevant British Standard Code of Practice.

In IE, the installation must be carried out by a Registered Gas Installer (RGI) and installed in accordance with the current edition of I.S.813 "Domestic Gas Installations", the current Building Regulations and reference should be made to the current ETCI rules for electrical installation.

Detailed recommendations are contained in the following British Standard Codes of Practice:

**BS. 5440:1** Flues (for gas appliances of rated input not exceeding 70 kW).

**BS. 5440:2** Ventilation (for gas appliances of rated input not exceeding 70 kW).

**BSEN. 12828:2003** Heating Systems in buildings: Design for

water based heating systems.

**BSEN 12831:2003** Heating Systems in buildings: Method for calculation of the design heat load.

**BSEN 14336:2004** Heating Systems in buildings: Installation and commissioning of water based heating systems.

**BS. 5546** Installation of gas hot water supplies for domestic purposes (2nd Family Gases).

**BS. 6798** Installation of gas fired hot water boilers of rated input not exceeding 70 kW.

**BS. 6891** Low pressure installation pipes.  
**Health & Safety Document No. 635.**

### The Electricity at Work Regulations, 1989.

The manufacturer's notes must NOT be taken, in any way, as overriding statutory obligations.

**IMPORTANT:** These appliances are CE certificated for safety and performance. It is, therefore, important that no external control devices, e.g. flue dampers, economisers etc., are directly connected to these appliances unless covered by these Installation and Servicing Instructions or as otherwise recommended by Warmhaus in writing. If in doubt please enquire.

Any direct connection of a control device not approved by Warmhaus could invalidate the certification and the normal appliance warranty. It could also infringe the Gas Safety Regulations and the above regulations.

## 1.6 Safe Handling Of Substances

No asbestos, mercury or CFCs are included in any part of the boiler or its manufacture.

## 1.7 Location Of Boiler

The boiler must be installed on a flat and vertical internal wall, capable of adequately supporting the weight of the boiler and any ancillary equipment.

The boiler may be fitted on a combustible wall and insulation between the wall and the boiler is not necessary, unless required by the local authority.

For electrical safety reasons there must be no access available from the back of the boiler.

### The boiler must not be fitted outside.

### Timber Framed Buildings

If the boiler is to be fitted in a timber framed building it should be fitted in accordance with the Institute of Gas Engineering document IGE/UP/7:2006 Edition 2.

### Bathroom Installations

This appliance is rated **IPX5D**.

The boiler may be installed in any room or internal space, although particular attention is drawn to the requirements of the current IEE (BS.7671) Wiring Regulations and the electrical provisions of the building regulations applicable in Scotland, with respect to the installation of the boiler in a room or internal space containing a bath or shower. For IE reference should be made to the current ETCI rules for electrical installations and I.S. 813:2002.

If the appliance is to be installed in a room containing a bath or shower then, providing water jets are not going to be used for cleaning purposes (as in communal baths/showers), the appliance must be installed beyond Zone 2, as detailed in BS.7671 (Figure 1.2).

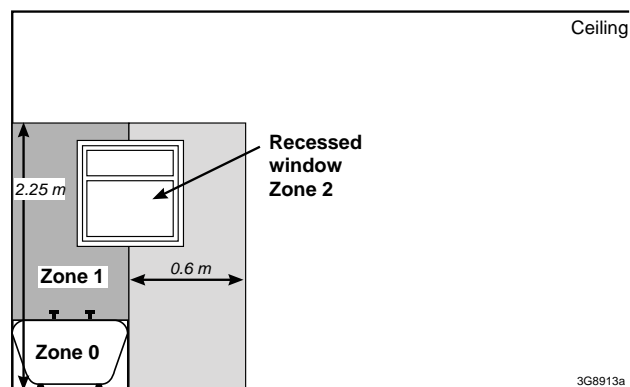

Figure 1.2

## Compartment Installations

A compartment used to enclose the boiler should be designed and constructed specially for this purpose.

An existing cupboard or compartment may be used, provided that it is modified for the purpose.

In both cases, details of essential features of cupboard / compartment design, including airing cupboard installation, are to conform to the following:

- BS 6798 (No cupboard ventilation is required - see 'Air Supply' for details).
- The position selected for installation MUST allow adequate space for servicing in front of the boiler.
- For the minimum clearances required for safety and subsequent service, see the wall mounting template and Section 1.13. In addition, sufficient space may be required to allow lifting access to the wall mounting plate.
- The boiler must be installed on a fire resistant surface.

## 1.8 Gas Supply

The local gas supplier should be consulted, at the installation planning stage, in order to establish the availability of an adequate supply of gas. An existing service pipe must NOT be used without prior consultation with the local gas supplier.

The boiler MUST be installed on a gas supply with a governed meter only.

A gas meter can only be connected by the local gas supplier or by a Gas Safe Registered Engineer. In IE by a Registered Gas Installer (RGI).

An existing meter should be checked, preferably by the gas supplier, to ensure that the meter is adequate to deal with the rate of gas supply required.

It is the responsibility of the Gas Installer to size the gas installation pipework in accordance with BS6891:2005. Whilst the principle of the

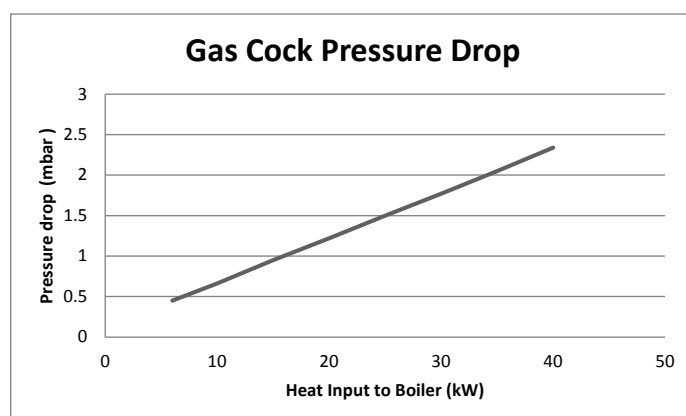

Figure 1.3

1:1 Gas valve ensures the Warmhaus Combi range is able to deliver its full output at inlet pressures as low as 14 mbar, other gas appliances in the property may not be as tolerant.

When operating pressures are found to be below the minimum meter outlet of 19 mbar these should be checked to ensure this is adequate for correct and safe operation.

Allowing for the acceptable pressure loss of 1 mb across the installation pipework, it can be assumed that a minimum permitted operating pressure of 18 mbar will be delivered to the inlet of the appliance. (Reference BS 6400-1 Clause 6.2 Pressure Absorption).

The external gas cock could further reduce the operating pressure when measured at its test point. The pressure drop is relative to the heat input to the boiler (kW), refer to graph below.

**IMPORTANT:** Installation pipes must be fitted in accordance with BS.6891. In IE refer to IS.813:2002.

The complete installation MUST be tested for gas tightness and purged as described in the above code.

### 1.9 Water Circulation System

**IMPORTANT:** A minimum length of 1 metre of copper pipe MUST be fitted to both flow and return connections from the boiler before connection to any plastic piping.

The central heating system should be in accordance with BS.6798 and, in addition, for smallbore and microbore systems, BS.5449

### WATER TREATMENT - see Section 1.16

### 1.10 Boiler Control Interlocks

Central heating systems controls should be installed to ensure the boiler is switched off when there is no demand for heating, in compliance with Building Regulations.

Heating systems utilising full thermostatic radiator valve control of temperature in individual rooms should also be fitted with a room thermostat controlling the temperature in a space served by radiators not fitted with such a valve.

When thermostatic radiator valves are used, the space heating temperature control over a living / dining area or hallway having a heating requirement of at least 10% of the minimum boiler heat output should be achieved using a room thermostat, whilst other rooms are individually controlled by thermostatic radiator valves. However, if the system employs thermostatic radiator valves on all radiators, or two port valves, then a bypass circuit must be fitted with an automatic bypass valve to ensure a flow of water should all valves be in the closed position.

### 1.11 Electrical Supply

**WARNING:** This appliance must be earthed.

Wiring external to the appliance MUST be in accordance with the current I.E.E. (BS.7671) Wiring Regulations and any local regulations which apply. For IE reference should be made to the current ETCI rules for electrical installations.

The mains supply to the boiler and system wiring centre shall be through one common fused double pole isolator and for new heating systems, and where practical replacement boiler installations, the isolator shall be situated adjacent to the appliance.

### 1.12 Condensate Drain

Refer to Section

A condensate drain is provided on the boiler. This drain must be connected to a drainage point on site. All pipework and fittings in the condensate drainage system MUST be made of plastic - no other materials may be used.

**IMPORTANT:** Any external runs must be in accordance with BS 6798. The drain outlet on the boiler is sized for standard 21.5 mm (3/4") overflow pipe. It is a universal fitting to allow use of different brands of pipework.

### 1.13 Boiler Dimensions, Services & Clearances

The boiler connections are made on the boiler connection tails. Refer to Section 2.15.

The following minimum clearances must be maintained for operation and servicing.

Additional space will be required for installation, depending upon site conditions.

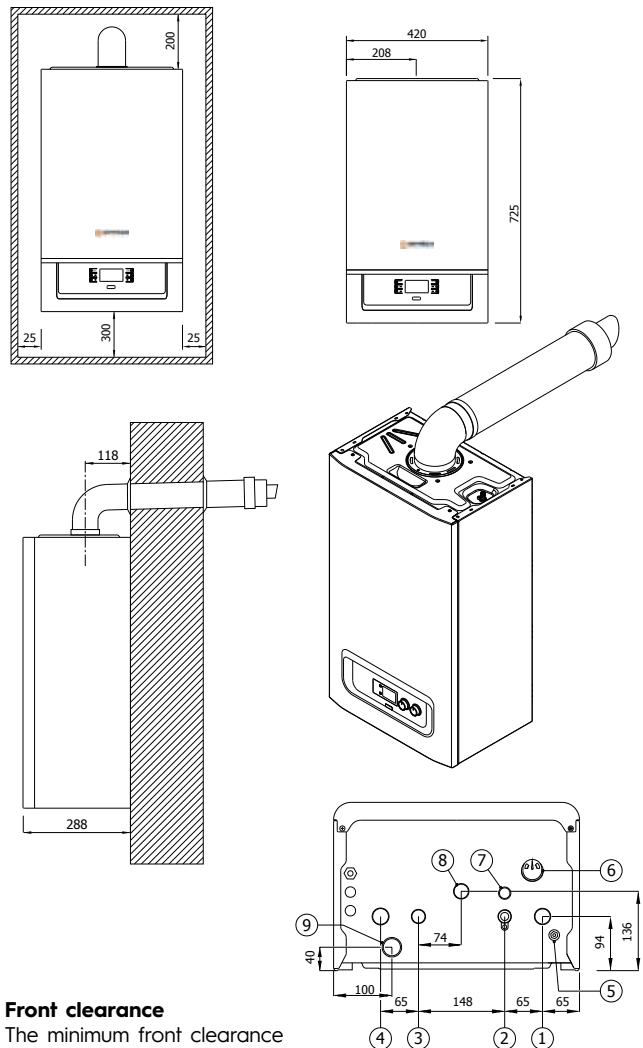

Figure 1.4

#### Front clearance

The minimum front clearance when built in to a cupboard is 5 mm from the cupboard door but 450 mm overall clearance is still required, with the cupboard door open, to allow for servicing.

#### \*Bottom clearance

Bottom clearance after installation can be reduced to 5 mm.

This must be obtained with an easily removable panel to provide the 100 mm clearance required for servicing.

1. Central Heating Return (CH-3/4" thread)
2. Domestic Hot Water Inlet (DHW-1/2" thread)
3. Domestic Hot Water Outlet (DHW-1/2" thread)
4. Central Heating Flow (CH-3/4" thread)
5. Drain Point
6. Manometer
7. Pressure Relief Valve Outlet
8. Gas Inlet
9. Condensate Drain (Ø24 mm)

## 1.14 System Requirements

### Central Heating

#### Notes

- a. The method of filling, refilling, tapping up or flushing sealed primary hot water circuits from the mains via a temporary hose connection is only allowed if acceptable to the local water authority.
- b. Antifreeze fluid, corrosion and scale inhibitor fluids suitable for use with boilers having stainless steel heat exchangers may be used in the central heating system.

#### General

1. The installation must comply with all relevant national and local regulations.
2. The installation should be designed to work with flow temperatures of up to 85 °C.
3. All components of the system must be suitable for a working pressure of 3 bar and a maximum design temperature of 110 °C. Extra care should be taken in making all connections so that the risk of leakage is minimised.

#### The following components are incorporated within the appliance:

- a. Circulating pump.
- b. Safety valve, with a non-adjustable preset lift pressure of 3 bar.
- c. Pressure gauge, covering a range of 0 to 4 bar.
- d. An 8-litre (for 24 kW) expansion vessel, with an initial charge pressure of 1.0 bar and 10 litre (for 28 and 33 kW) expansion vessel, with an initial charge pressure of 1.0 bar.

#### 4. 'Make-up' Water. Provision must be made for replacing water loss from the system, either:

- a. From a manually filled 'make-up' vessel with a readily visible water level. The vessel should be mounted at least 150 mm above the highest point of the system and be connected through a non-return valve to the system, fitted at least 150 mm below the 'make-up' vessel on the return side of the radiators. Or
- b. Where access to a 'make-up' vessel would be difficult, by pre-pressurisation of the system.

The maximum cold water capacity of the system should not exceed 143 litres, if not pressurized. However, if the system is to be pressurized, the efficiency of the expansion vessel will be reduced and a larger vessel (or smaller system volume) may be necessary. If the capacity of the vessel is not considered sufficient for this, or for any other reason, an additional vessel MUST be installed on the RETURN to the boiler.

Guidance on vessel sizing is given in Table opposite.

#### 5. Filling

The system may be filled by the following method: Where the mains pressure is excessive a pressure reducing valve must be used to facilitate filling.

- a. Thoroughly flush out the whole system with cold water.
- b. Fill and vent the system until the pressure gauge registers 1bar and examine for leaks. Refer to Section 2.15 for filling detail.
- c. Check the operation of the safety valve by raising the water pressure until the valve lifts. This should occur within 0.3 bar of the preset lift pressure.
- d. Release water from the system until the minimum system design pressure is reached; 1.0 bar if the system is to be pre-pressurised.

Safety valve setting bar	3.0	
Vessel charge pressure bar	0.5 to 0.75	
System pre-charge pressure bar	None 1.0	
<b>System volume (litres)</b>	<b>Expansion vessel volume (litres)</b>	
25	1.6	1.8
50	3.1	3.7
75	4.7	5.5
100	6.3	7.4
125	7.8	9.2
150	9.4	11.0
175	10.9	12.9
190	11.9	14.0
200	12.5	14.7
250	15.6	18.4
300	18.8	22.1
<b>For other system volumes multiply by the factor access</b>	0.063	0.074

Table 1.11

### Water Flow Rate and Pressure Loss

#### Domestic Hot Water

1. The domestic hot water service must be in accordance with BS 5546 and BS 6700.
2. Refer to Table 1.6 for minimum and maximum working pressures. In areas of low mains water pressures the domestic hot water regulator may be removed from the DHW flow turbine cartridge. Refer to Section 4.62, page 112. The boiler will require the flow rate to be set to obtain a temperature rise of 35°C at the tap furthest from the boiler.
3. The boiler is suitable for connection to most types of washing machine and dishwasher appliances.
4. When connecting to suitable showers, ensure that:
  - a. The cold inlet to the boiler is fitted with an approved anti-vacuum or syphon non-return valve.
  - b. Hot and cold water supplies to the shower are of equal pressure.

#### 5. Hard Water Areas

Where the water hardness exceeds 200 mg/litre, it is recommended that a proprietary scale reducing device is fitted into the boiler cold supply within the requirements of the local water company.

**IMPORTANT:** Provision MUST be made to accommodate the expansion of DHW contained within the appliance, if a non-return valve is fitted to the DHW inlet, or a water meter with a non-return valve is installed.

Cold water rising main and pipework in exposed areas need to be suitably lagged to prevent freezing.

## 1.15 System Balancing

The boiler does not normally need a bypass but at least some radiators on the heating circuit, of load of at least 10% of the minimum boiler output, must be provided with twin lockshield valves so that this minimum heating load is always available. See note regarding thermostatic radiator valves on page to section 1.10.

**Note:** Systems incorporating zone valves which could completely cut off the flow through the system must also include a bypass.

### BALANCING

1. Set the programmer to ON.

Close the manual or thermostatic valves on all radiators, leaving the twin lockshield valves (on the radiators referred to above) in the OPEN position.

Turn up the room thermostat and adjust the lockshield valve to give an uninterrupted flow through the radiator. These valves should now be left as set.

2. Open all manual or thermostatic radiator valves and adjust the lockshield valves on the remaining radiators, to give around 20 °C temperature drop at each radiator.

3. Adjust the room thermostat and programmer to NORMAL settings.

## 1.16 See Section

### Central Heating

The Warmhaus Combi range boiler has an STAINLESS STEEL alloy heat exchanger.

### Preconditions of boiler installation

Water pH has to be within the following limits:  $7.5 < \text{pH} < 9.5$

Water hardness has to be within the following limits:  $5^\circ\text{F} < \text{TH} < 15^\circ\text{F}$

### IMPORTANT

**The application of any other treatment to this product may render the guarantee of Warmhaus Invalid.**

Warmhaus recommend Water Treatment in accordance with the Benchmark Guidance Notes on Water Treatment in Central Heating Systems.

Warmhaus recommends to indicate that boiler installation has to be made on heating systems (new or existing) properly treated so that there is no trace of impurity, dust, sand, copper remainings, grease, carbonaceous deposits, etc.

In case of boiler replacement, as well as on new heating systems, a treatment has to be recommended.

Black mud (magnetite -  $\text{Fe}_3\text{O}_4$ ) creates as a result of a continuous electrolytic corrosion of any heating system which is not protected by an inhibitor. Iron oxide ( $\text{Fe}_2\text{O}_3$ ) (red mud) is produced during the continuous heating system oxygenation. Limescale deposits on hotter internal surfaces in proportion to water hardness used in the heating system.

Muds and limescale mix together, representing the cause of the majority of heating systems problems observed on the field. The presence of these substances means that standard preventive measures have not been taken, and they inhibit any aspect related to boiler guarantee.

Warmhaus suggests the use of following products for preventive and curative treatment of boilers/heating systems provided with Warmhaus boilers.

**If water treatment is used Warmhaus recommend only the use of inhibitors and associated water treatment products, which must be used in accordance with the manufacturers' instructions.**

	Fernox	Sentinel
Inhibitor	Protector F1	X100
Heating system cleaning (new)	Cleaner F5	X300
Heating system cleaning (already existing)	Cleaner F5	X400
Mud removal	Cleaner F5	X800
Antifreeze	Alphi 11	X500
Noice reduction	Silencer F2	X200
Sanitizer and biocide	AF10	X700

Table 1.12

### Notes:

1. It is most important that the correct concentration of the water treatment products is maintained in accordance with the manufacturers' instructions.
2. If the boiler is installed in an existing system any unsuitable additives MUST be removed by thorough cleansing. BS 7593:2006 details the steps necessary to clean a domestic heating system.
3. In hard water areas, treatment to prevent lime scale may be necessary - however the use of artificially softened water is NOT permitted.
4. Under no circumstances should the boiler be fired before

### DOMESTIC HOT WATER

In hard water areas where mains water can exceed 200ppm Total Hardness (as defined by BS 7593:2006 Table 2) a scale reducing device should be fitted into the boiler cold supply within the requirements of the local water company. The use of artificially softened water, however, is not permitted.

Warmhaus recommend the use of Fernox Quantomat, Sentinel Combiguard or Calmag CalPhos I scale reducing devices together with scalemaster in-line scale inhibitor branded Ideal, which must be used in accordance with the manufacturers' instructions.

### For further information contact

Fernox Cookson Electronics  
Forsyth Road, Sheerwater, Woking, Surrey GU21 5RZ  
+44 (0) 870 601 500

### Sentinel Performance Solutions

The Heath Business & Technical Park, Runcorn, Cheshire WA7 4QX  
Tel: 0800 389 4670  
www.sentinel-solutions.net

### Scalemaster Water Treatment Products

Emerald Way, Stone, Staffordshire ST15 0SR  
Tel: +44 (0) 1785 811636

### Calmag Ltd.

Unit 3-6, Crown Works, Bradford Road, Sandbeds, Keighley, West Yorkshire BD20 5LN  
Tel: +44 (0) 1535 210 320

### Adey Professional Heating Solutions

Gloucester Road, Cheltenham GL51 8NR  
Tel: +44 (0) 1242 546700



# SECTION 2 INSTALLATION PERSONNEL SECTION

---

Priwa & Enerwa  
Priwa Plus & Enerwa Plus



## 2.1. Contents Of Packing Box

Warmhaus is sold as two boxes with boiler and flue set. Combi box contains below listed materials and small box contains exhaust gas flue pipes.

### I. Installation Scheme (Figure 1)

### II. User's Guide (Figure 2)

### III. Connection Accessories (Figure 3)

- a. 1 throttle screw (installed at flue output).
- b. 2 hanger screws
- c. 2 Dowels

### IV. Hanger Plate (Figure 4)

### V. Exhaust Gas Flue Set (Figure 5)

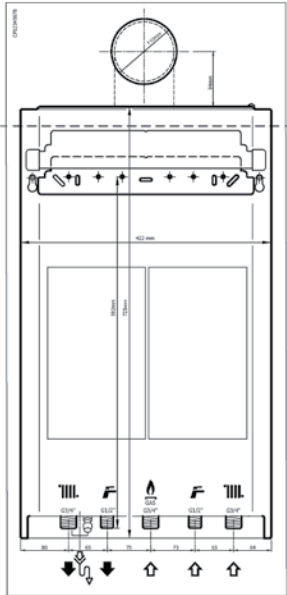

Figure 2.1 Installation scheme



Figure 2.2 User's Guide



Figure 2.3 Connection accessories



Figure 2.4 Hanger plate



Figure 2.5 Exhaust gas flue set



Do not leave packing materials (plastic, nylon, bags, etc.) at places to be reached by children for preventing any dangers for suffocation.

## 2.2 Flue System



When installing a replacement boiler a new flue system is delivered with the boiler as original flue set must be used and re-using the existing boiler flue installation is strictly not acceptable

### Design

Individual air supply and flue outlet pipes are used as standard. The material approved for this application which MUST be used are:

### Termination Of The Flue And Air

The flue and air pipes may terminate independently through any external walls within the same dwelling except on opposing walls, within the maximum lengths shown in graph below. (Alternatively a vertical flue pipe termination is acceptable.)

The air pipe must have an elbow and 150 mm length of pipe directed downwards with a termination grill fitted.

The air pipe can be situated at the side or beneath the flue pipe to a minimum dimension of 140 mm (see diagram below). It must not be sited above the flue pipe.

The flue and air pipes must extend by at least 40 mm from the wall surface.

Condensing boiler emit a visible plume of water vapour from the flue terminal, this is normal. It is the responsibility of the installer to judiciously select a terminal location that does not cause a nuisance.

If either the flue or air terminal is below a height of 2 m from ground level a terminal guard must be fitted.

Note. Any vertical termination MUST have the terminals fitted and the air intake comply with the dimensions above

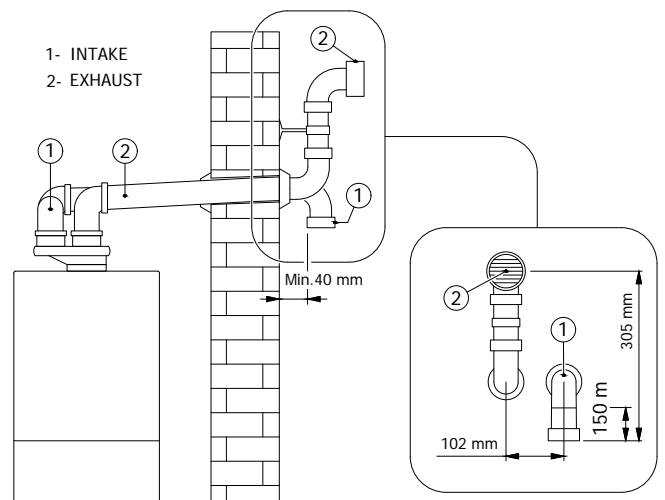

Figure 2.6

**2.3 Maximum Lengths**

Due to the resistance presented by extended flue length a slight reduction in maximum boiler output will occur where combined flue and air lengths in excess of 10.0 m are used. In such cases the boiler output will be reduced by 0.6% and 0.8% per additional metre.

The maximum lengths of both air inlet pipe and flue outlet pipe, when no bends are used, are as detailed in graphs below. However, each bend used has an equivalent length that must be deducted from the

maximum straight length stated in graphs below. Knuckle bends must not be fitted.

A 92.5° swept elbow is equivalent to 1.0 m straight length. A 45° bend is equivalent to 0.5 m straight length. It is possible to have variable flue and air lengths as described within the shaded area of graphs below.

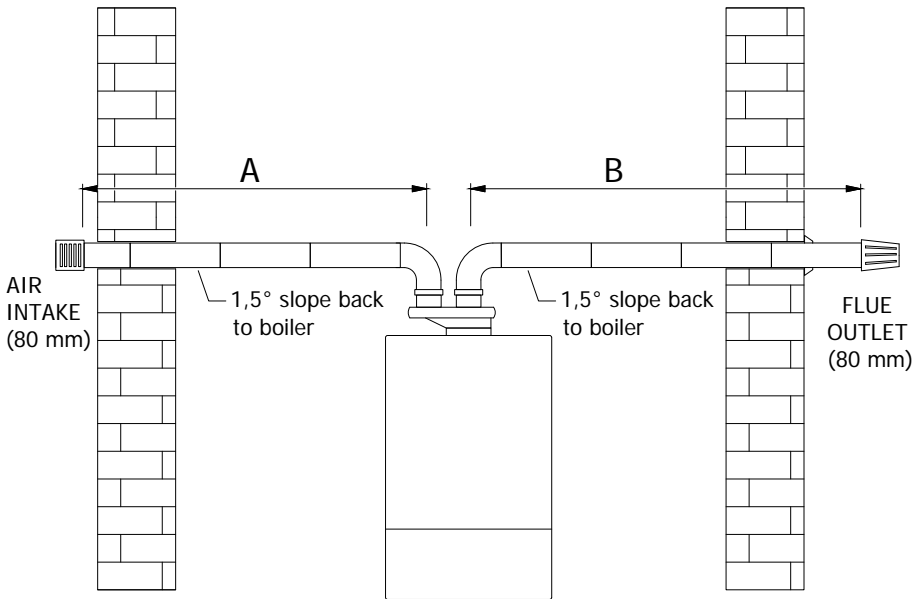

TOTAL HORIZONTAL LENGTH : A+B = 36 m

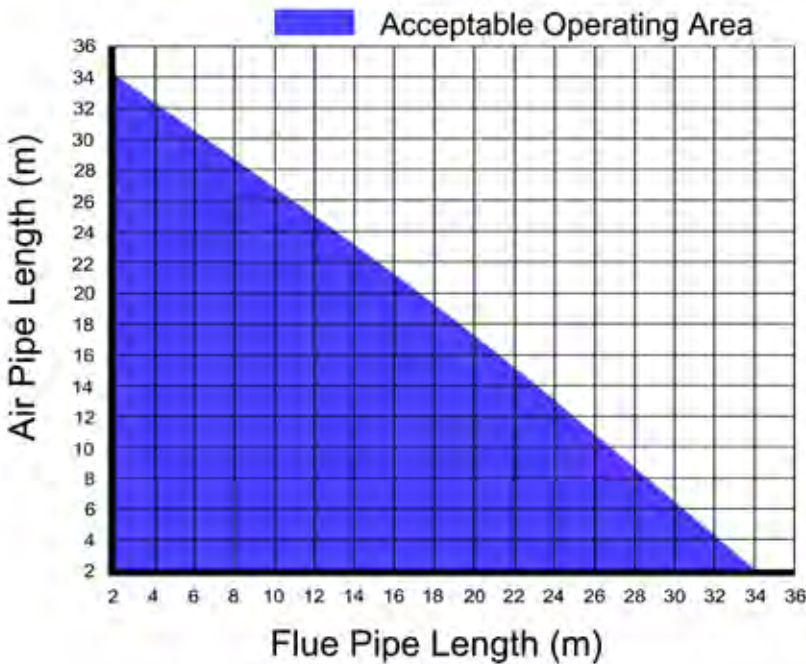

Figure 2.7 Air-Flue Lengths

! For more examples refer to page 25 (Fig. 2.20 and 2.21)

## 2.4 Slope

'Horizontal' flue outlet pipework MUST slope at least 1.5 degrees (26 mm per metre run) downwards towards the boiler. Pipework can be vertical. Only swept elbows can be used.

Air inlet pipework can be truly horizontal or vertical, or sloping in a downward direction towards the boiler but in each case rain, etc., must be prevented from entering the pipe. There must be no troughs in any of the pipework, whether it be air inlet or flue outlet.

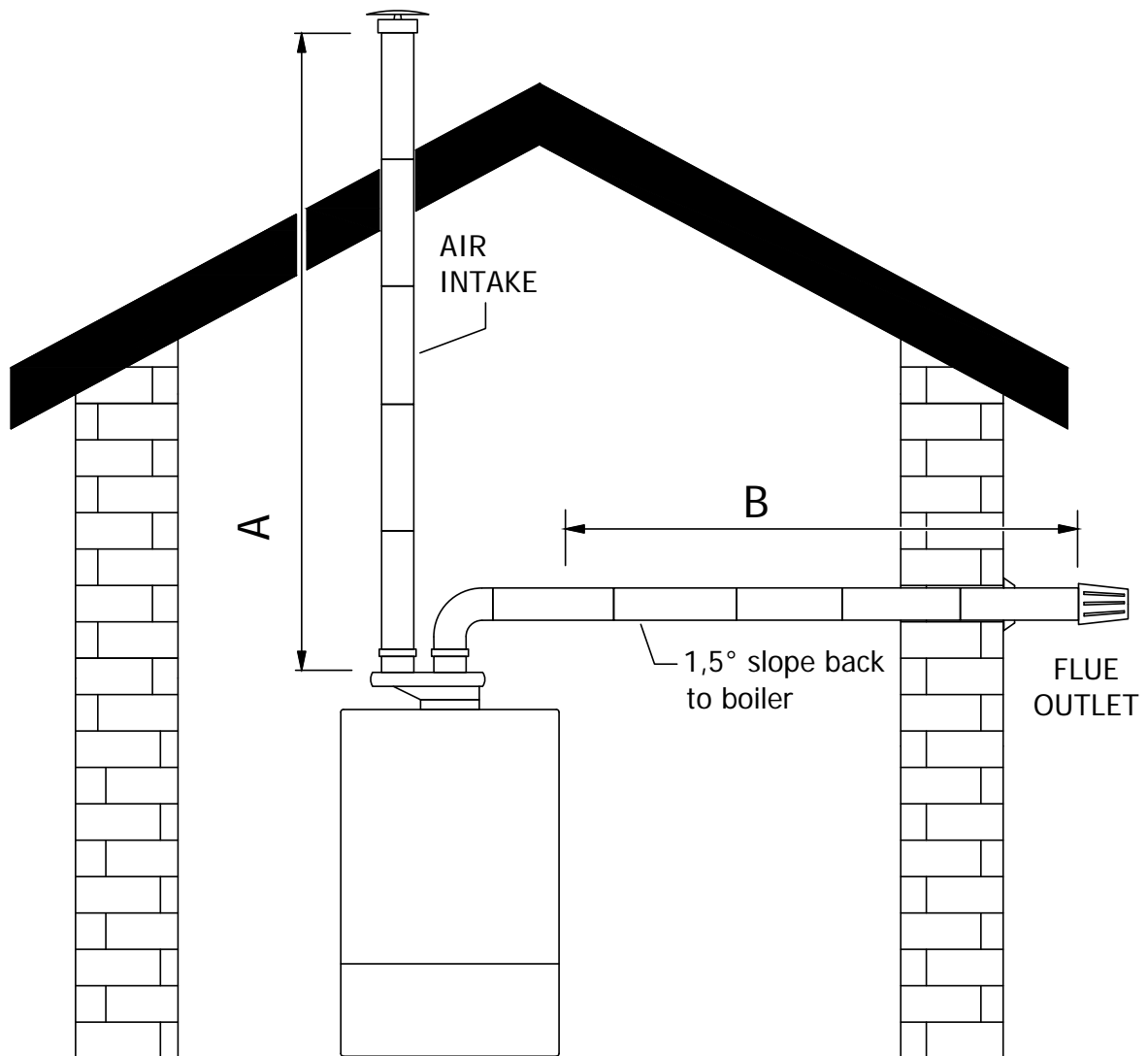

TOTAL VERTICAL LENGHT :  $A+B = 30\text{ m}$

Figure 2.8

## 2.5 Flue Termination Position

### Peripheral Distances of Flue Output Connections

In order to position the flue set output pipe

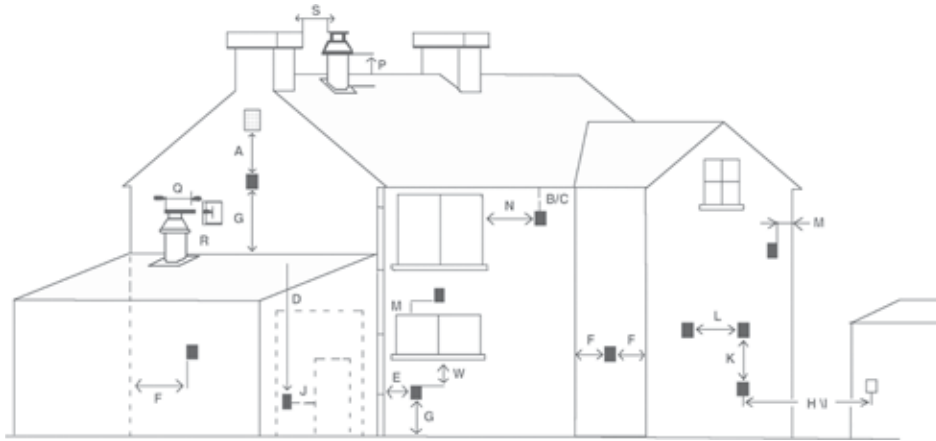

	Flue Position	Minimum Distance
A	30 mm under a window	30 mm.
B	Under water groove	75 mm.
C	Under fringes	20 mm.
W	Under balconies	200 mm.
E	To vertical water discharge pipes	150 mm.
F	Interior or exterior corners	300 mm.
G	At ground, roof or balcony level	300 mm.
H	On another wall corresponding to the flue	600 mm.
S	To another flue To another wall than the garage wall	1200 mm.
J	To another wall than the garage wall	1200 mm.
R	To another flue than the same wall (vertical)	1500 mm.
Q	To another flue than the same wall (vertical)	300 mm.
M	On another window/culvert On another window/culvert vertically	300 mm.
P	On the roof level	300 mm.
F	To an adjacent wall	300 mm.
I	To the window on adjacent wall	300 mm.
L	To another flue	1000 mm.

**Additional note:** From a terminal facing a terminal > 1200 mm (on the Figure H or I)

**Additional note:** For type C5 boilers: The instruction that the terminals for the supply of combustion air and for the evacuation of combustion products shall not be installed on opposite walls of the building.

Figure 2.9 Flue peripheral positions and minimum distances

### General Installations

All parts of the system must be constructed in accordance with BS 5440 Part 1, except where specifically mentioned in these instructions. All pipe work must be adequately supported.

All joints other than approved push-on or plastic compression connectors must be made and sealed with solvent cement suitable for muPVC pipes and conforming to BS 6209: 1982.

Consideration must be given to Corgi/Gas Safe bulletin TB200/TB008 regarding flues in voids.

The boiler casing must always be correctly fitted to the boiler when leaving the appliance operational. External wall faces and any internal faces of cavity walls must be good.

### Air Supply

The Warmhaus Combi is a room-sealed appliance and therefore does not require purpose provided ventilation to the boiler room for combustion air.

### Compartment Installation

Due to the low casing temperatures generated by the boiler, no compartment ventilation is required. However, the cupboard or compartment must not be used for storage.

## 2.6 Installing The Boiler

Installation of the boiler is straightforward but consideration must be given to access to allow flue and air pipes to be pushed through walls and ceilings. The order in which the components are installed will depend upon particular site conditions, but in general it will be easiest and most accurate to install the boiler and then build up the flue outlet and air inlet pipes to the terminal - this is the sequence described.

## 2.7 Mounting The Boiler

1. Ensure the plastic plugs are removed from both the CH and DHW connections before mounting the boiler.
2. Lift the boiler onto the wall mounting plate (refer to the Introduction section for safe handling advice), locating it over the two tabs.

## 2.8 Assembly Practice

Remove all plastic debris and burrs when installing air intake piping. Plastic fillings caused by cutting muPVC pipe must not be allowed to be drawn into the combustion air blower. Prevent dust entering the air intake when cutting on building sites. Blower failure which is determined to be caused by plastic fillings or other debris will not be covered by guarantee.

### Installing Flue And Air Pipes

Important - When installing a replacement boiler a new flue system is recommended.

- Ensure the condense trap/siphon is filled with water.
- Measure, cut and check the air and flue pipes to pass to the exit from the wall(s) or ceiling.
- Always thoroughly deburr all pipes and most important, remove shavings from within the pipe.
- Assemble, using solvent weld cement, the pipework from the boiler connections to the exit from the first wall/ceiling, (remount the boiler if removed). When pushing pipe through walls, ensure grit and dust is not allowed to enter the pipe.

**Ensure pipes are fully engaged into sockets and solvent welded with no leaks.**

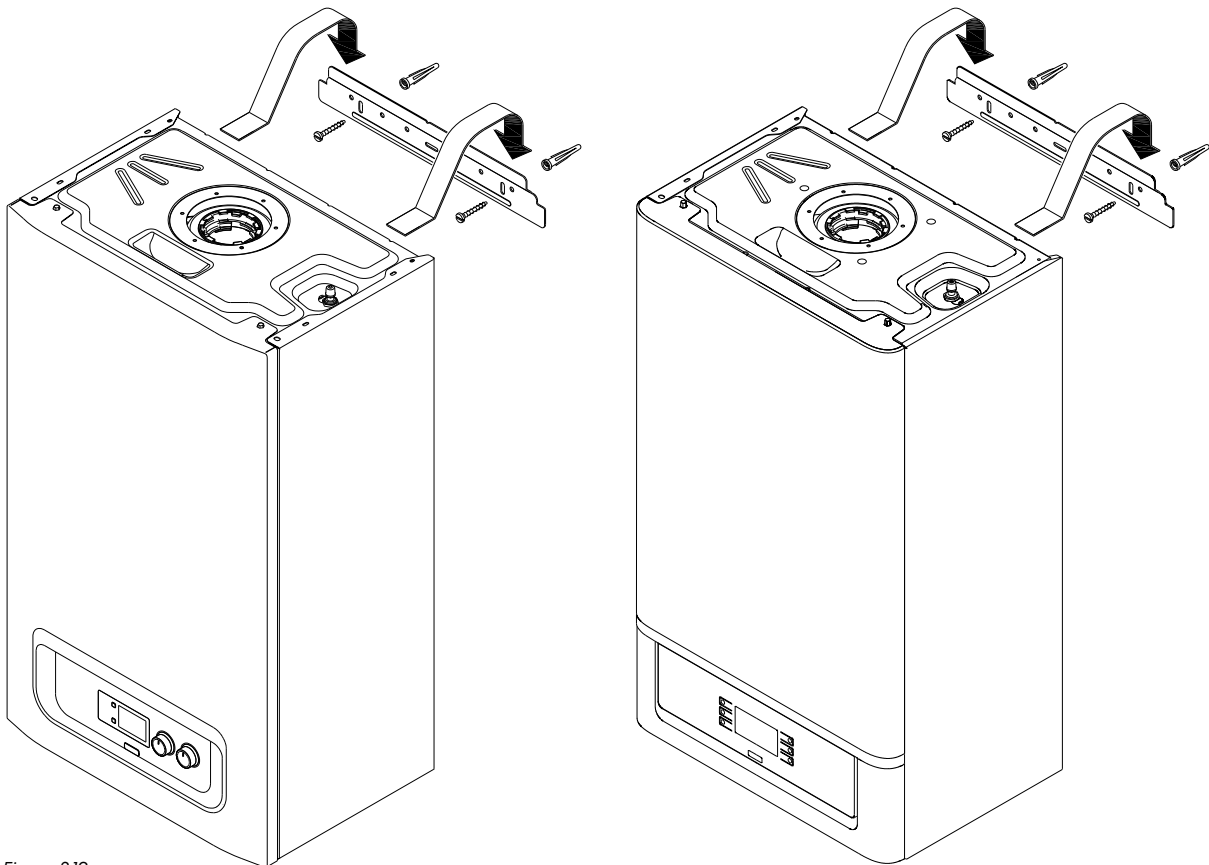

Figure 2.10

**2.9 Installation With Horizontal Flue Sets**

Connecting Horizontal Homocentric Flue Set to the Combi, (original diameter DN 60/100 mm)

Since your combi is hermetic model, it takes the used air from exterior and discharges exhaust gases created as the result of burning through the same flue group. In order to prevent emission of excessively harmful exhaust gases, flue usage and installation is very important, therefore warnings should be taken into consideration when flue connections are being performed.

- Make required flue selection for the flue connection to be made external and installation place of the combi. If the standard flue set is not adequate, please select most suitable elements from our list of connection accessories considering warnings given in our user's guide.
- Fix the flange under the Bend piece (1) by using the Flange Bolt (10) via Flange Connection Screws (11) to holes on the combi.
- 2 impermeability bolts within the hermetic flue set (2) are placed into internal pipe slots at both ends of the 90° Bend.

- Place the exterior wall (EPDM) bolt into the flue terminal as seen in Figure 2.13 for grouping the flue output terminal. After placing the flue output terminal through exterior of wall and the previously opened hole, fix the Interior Wall Connection Bolt (7) into the flue terminal.
- **Support any pipes whose route could be displaced either of its own accord or by accident. Any horizontal run over 1 m or vertical runs of any length must always be supported. Brackets should be placed at intervals of approximately 1 m. Brackets should be loose enough on the pipe to allow thermal expansion and contraction movement.**
- **Flue pipework through walls MUST be sleeved to allow thermal expansion and contraction movement.**
- Check all connections for security and re-seal any joints using solvent cement where soundness may be in doubt.

**Note:** It is equally important to seal the air inlet with solvent cement as the flue outlet pipe joints.

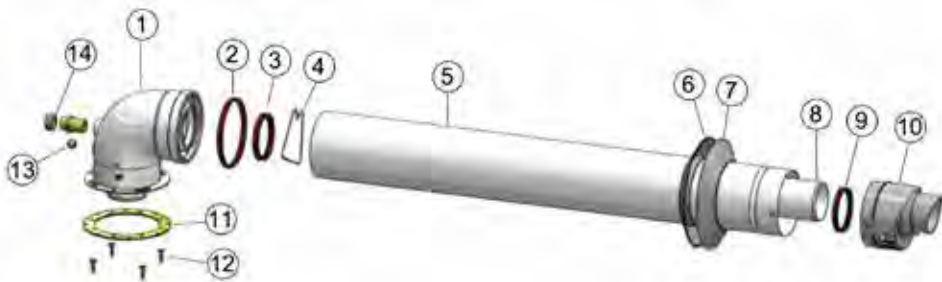

1. 90° bend
2. Sealing gasket
3. Sealing gasket
4. Centering wire
5. Exterior flue pipe
6. Interior wall closing flange
7. Exterior wall closing flange
8. Interior flue pipe
9. Ø60 sealing gasket
10. Flue/Air Grille
11. Flange gasket
12. Flange connection screws
13. Control measurement cork
14. Fresh air control cap

Figure 2.11 Hermetic combi homocentric flue set

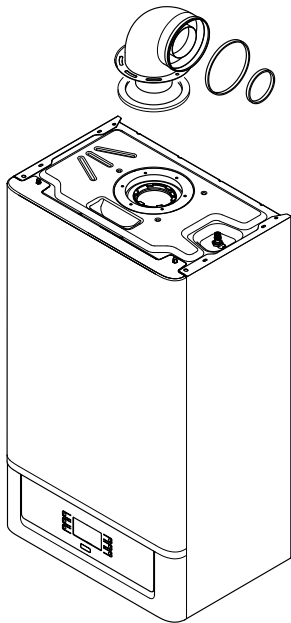

Figure 2.12 Installation of flue set pieces

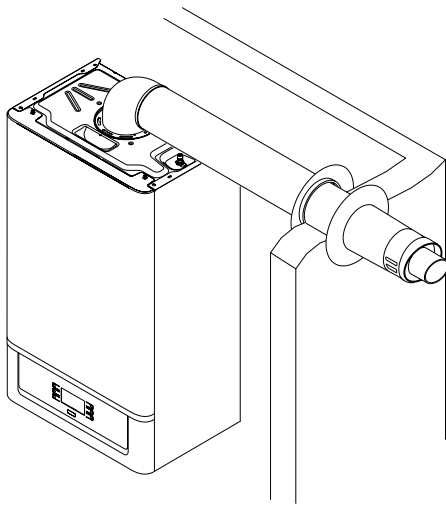





Figure 2.13 Hermetic combi homocentric flue wall output

Place other end of EPDM connection gasket to flue output terminal. Pay attention to correct placement of gaskets:  
 • Click-fit gasket for homocentric extension pipes and bends. In order to connect possible extension connections of exhaust gas flues with other elements of flues: Connect from homocentric pipe or homocentric bend male part (flat) to female part of the previous piece (gasket side), in such case ensure that required stamp is placed, therefore the piece maintaining tightness and the set shall be combined.

 When it is required to shorten the discharge flue and/or extension, consider that internal pipe should protrude 5 mm when compared with the external pipe.

 For security purposes, combi suction / discharge flue should not be blocked even temporarily.

 During installation of horizontal pipes, the pipe slope should be kept at 3% upwards as minimum and dowel at every 3 meters and holder clamps should be used.

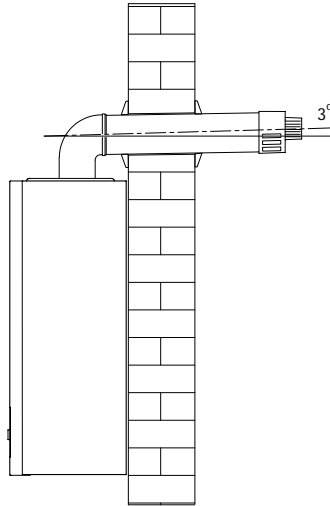

Figure 2.14 Condensing combi flue training

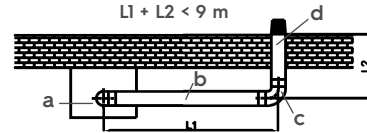

Figure 2.15 II. Two 90° bended sample flue installations

- a- Standard Flue Set Bend (45°)
- b- Flue Extension Pipe
- c- Additional 90° Bend
- d- Standard Flue Set Pipe

Total length of hermetic flue set should not exceed 10 m with single bend horizontally. Also, this total length reduces by 1 m with every 90° bends or two 45° bends. Maximum 3 pieces of 90° bend can be used.

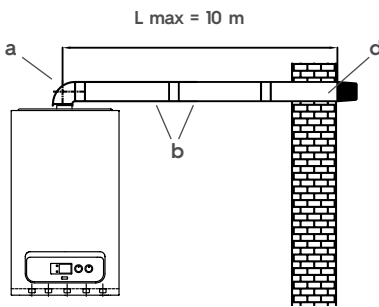

Figure 2.16 I. Single 90° bended sample flue installation

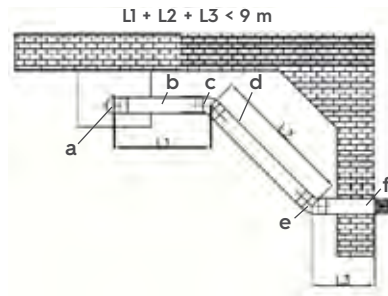

Figure 2.17 III. Single 90° and two 45° bended sample flue installations

- a- Standard Flue Set Bend (45°)
- b- Flue Extension Pipe
- c- Additional 45° Bend
- d- Standard Flue Set Pipe
- e- Additional 45° Bend
- f- Standard Flue Set Pipe

## 2.10 Installation With Vertical Flue Sets

Your combi can also be vertically connected to flat and aslope roofs via available connection accessories depending on the status of installation place. For flat connections (Ø 60/100 mm) vertical flue set should not exceed 11 m.



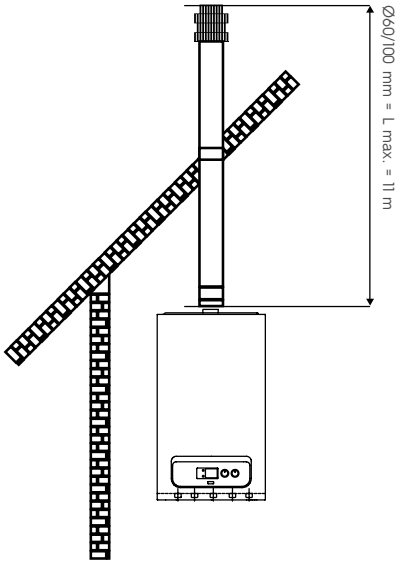

Figure 2.18 Vertical flue set installation

Implementation

- L1** = 0.3 m.
- L2** = 0.5 m. (45° bend equivalent length)
- L3** = 2.0 m.
- L4** = 0.5 m. (45° bend equivalent length)
- L5** = 1.0 m.
- L6** = 0.5 m.

$L \text{ Total} = 6.3 \text{ m.} \quad 6.3 \text{ m.} < L_{\text{max}} = 11 \text{ m.}$

Correct in implementation

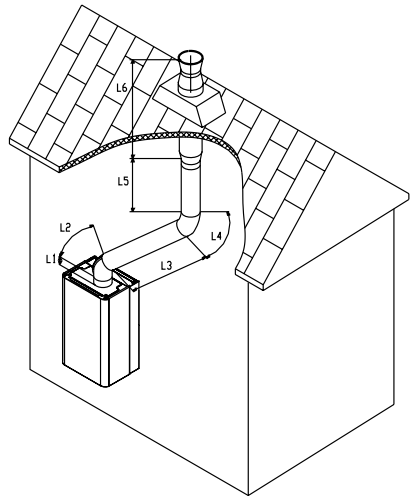

Figure 2.19 Vertical flue set installation application

**2.11 Separator Kit Ø 80/80 (Hermetic) Flue Type Use**

This kit allows air to come in from outside the building and the fumes to exit from the chimney or flue through divided flue exhaust and air intake pipes. Combustion products are expelled from pipe (F) (in plastic, so as to resist acid condensate). Air is taken in through duct (A) for combustion (this is also in plastic). Extensions for separator kit Ø 80/80. The maximum vertical straight length (without bends) that can be used for Ø 80 intake and exhaust pipes is 36 metres, regardless from whether they are used for intake or exhaust. The maximum horizontal straight length (with bend in suction and in exhaust) that can be used for Ø 80 intake and exhaust pipes is 30 metres, regardless from whether they are used for intake or exhaust.

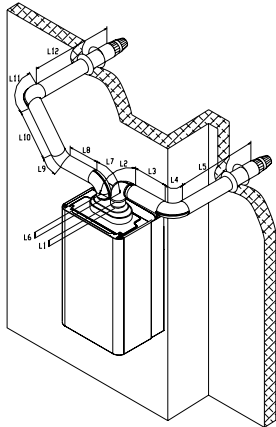

Figure 2.20 Hermetic flue type installation sample

Implementation

- L1** = 0.5 m.
- L2** = 1.0 m. (90° bend equivalent length)
- L3** = 1.5 m.
- L4** = 1.0 m. (90° bend equivalent length)
- L5** = 1.5 m.
- L6** = 0.5 m.
- L7** = 1.0 m. (90° bend equivalent length)
- L8** = 0.5 m.
- L9** = 0.5 m. (45° bend equivalent length)
- L10** = 1.5 m.
- L11** = 1.0 m. (90° bend equivalent length)
- L12** = 1.5 m.

$L \text{ Total} = 12 \text{ m.} \quad 12 \text{ m.} < L_{\text{max}} = 30 \text{ m.}$

Correct in implementation

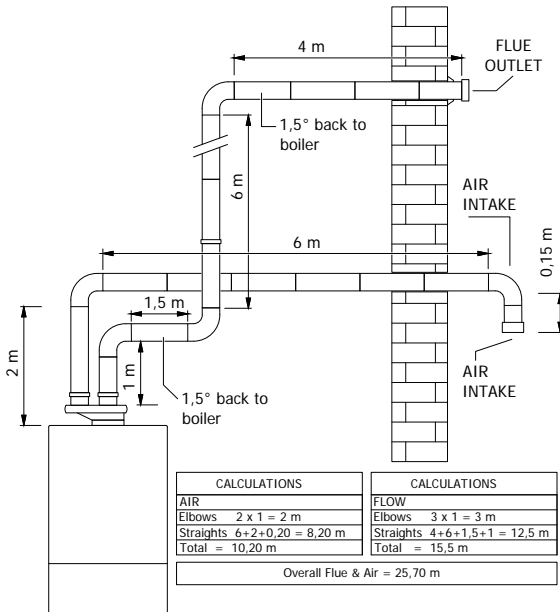

Figure 2.21 Separator (Twin) Flue Kit Installation example Warmhaus combi 2530C, 3035C, 3540C

## 2.12 Condensate

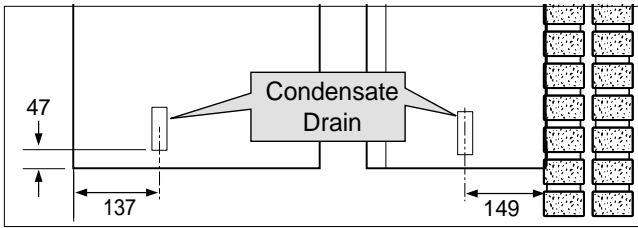

Figure 2.22

This appliance is fitted with a siphonic 75 mm condensate trap system that requires filling before operating the appliance for the first time or after maintenance.

All condensate pipework should conform to the following:

- Where a new or replacement boiler is being installed, access to an internal 'gravity discharge' termination should be one of the main factors considered in determining boiler location.
- Plastic with push fit or solvent connections.
- Internal plastic pipe work a minimum of 19 mm ID (typically 22 mm OD)
- External plastic pipe must be a minimum of 30 mm ID (typically 32 OD) before it passes through the sleeved wall.
- All horizontal pipe runs, must fall a minimum of 45 mm per metre away from the Boiler.
- External & unheated pipe work should be kept to a minimum and insulated with Class "O" waterproof pipe insulation.
- All installations must be carried out in accordance to the relevant connection methods as shown in the "Condensate installation diagrams" & BS6798:2009
- Pipe work must be installed so that it does not allow spillage into the dwelling in the event of a blockage (through freezing)
- All internal burrs should be removed from the pipe work and any fittings.

In order to minimise the risk of freezing during prolonged very cold spells, one of the following methods of terminating condensate drainage pipe should be adopted.

### Internal Drain Connections

Wherever possible, the condensate drainage pipe should be routed to drain by gravity to a suitable internal foul water discharge point such as an internal soil and vent stack or kitchen or bathroom waste pipe etc. See Figs 2.23 and 2.24.

### Condensate Pump

Where gravity discharge to an internal termination is not physically possible or where very long internal pipe runs would be required to reach a suitable discharge point, a condensate pump of a specification recommended by the boiler or pump manufacturer should be used terminating into a suitable internal foul water discharge point such as an internal soil and vent stack or internal kitchen or bathroom waste pipe etc. (Fig 2.25).

### External Drain Connections

The use of an externally run condensate drainage pipe should only be considered after exhausting all internal termination options as described previously. An external system must terminate at a suitable foul water discharge point or purpose designed soak away. If an external system is chosen then the following measures must be adopted:

The external pipe run should be kept to a minimum using the most direct and "most vertical" route possible to the discharge point, with no horizontal sections in which condensate might collect.

- For connections to an external soil/vent stack see Fig 2.26. Insulation measures as described should be used.
- When a rainwater downpipe is used, an air break must be installed between the condensate drainage pipe and the downpipe to avoid reverse flow of rainwater into the boiler should the downpipe become flooded or frozen, see Fig 2.27.

- Where the condensate drain pipe terminates over an open foul drain or gully, the pipe should terminate below the grating level, but above water level, to minimise "wind chill" at the open end. The use of a drain cover (as used to prevent blockage by leaves) may offer further prevention from wind chill. See Fig 6.
- Where the condensate drain pipe terminates in a purpose designed soak away (see BS 6798) any above ground condensate drain pipe sections should be run and insulated as described above. See Fig 7

### Unheated Internal Areas

Internal condensate drain pipes run in unheated areas, e.g. lofts, basements and garages, should be treated as external pipe. Ensure the customer is aware of the effects created by a frozen condensate and is shown where this information can be found in the user manual.

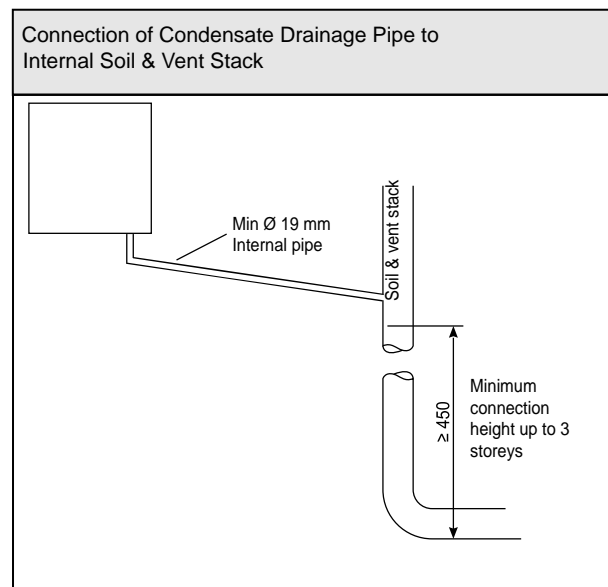

Figure 2.23

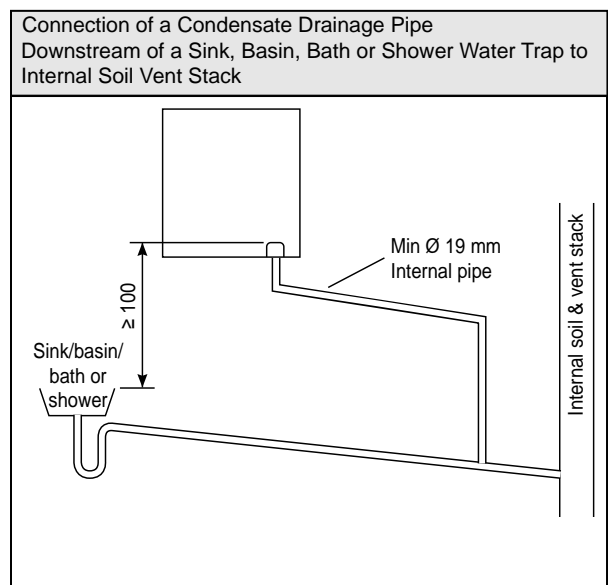

Figure 2.24

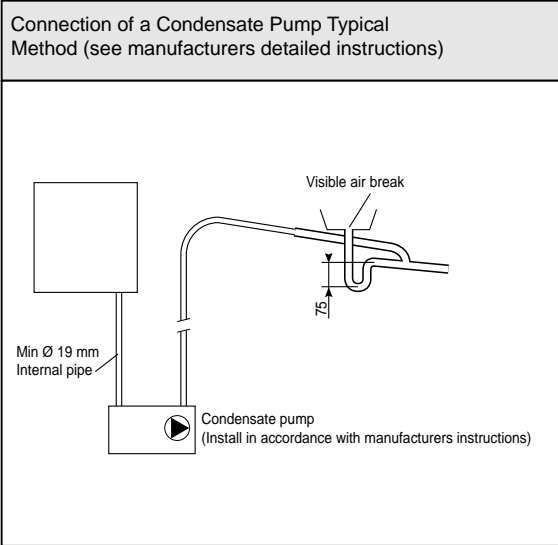

Figure 2.25

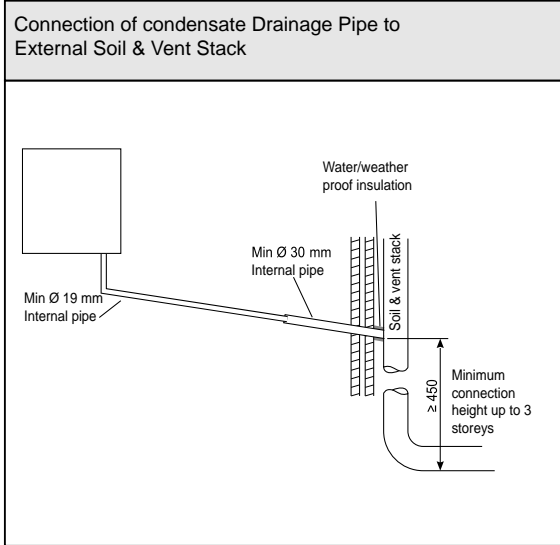

Figure 2.26

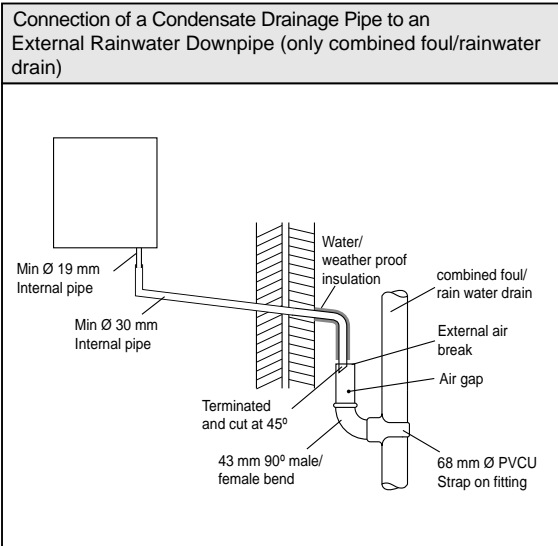

Figure 2.27

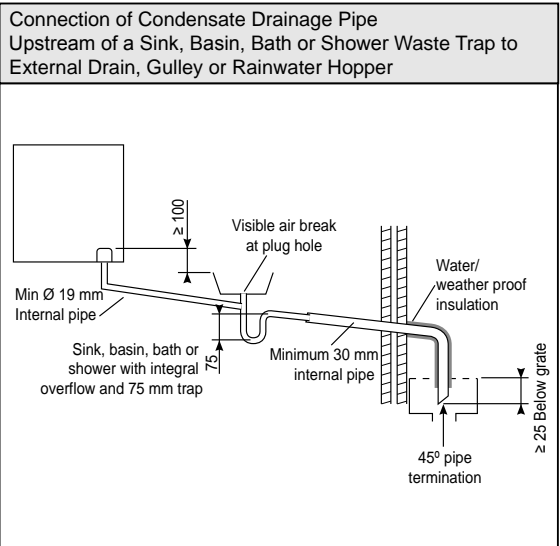

Figure 2.28

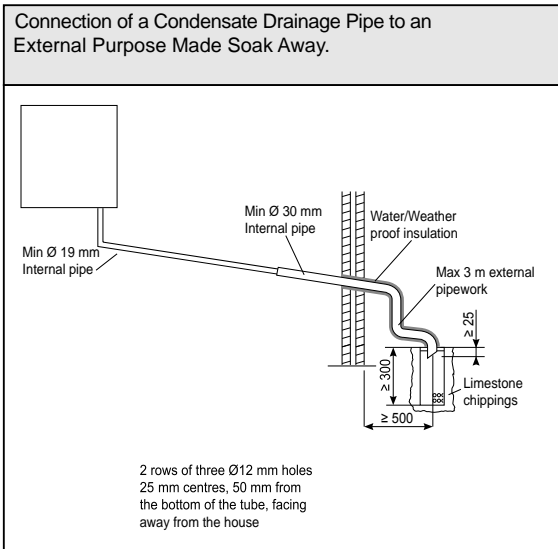

Figure 2.29

### 2.13 Connections & Filling

**NOTES:**

Ensure all boss blanking plugs are removed before connecting hardware. Each valve must be fitted to the correct boss as shown in the picture. Ensure each union is fitted with fibre seals provided.

Do not subject any of the isolating valves to heat as the seals may be damaged.

**WATER CONNECTIONS CH**

1. Connect the CH flow service valve (black handle) and copper tail provided in the hardware pack to the threaded boss connection provided\* at the lower rear of the boiler (\* OPTIONAL).
2. Connect the CH rtn. valve (black handle) and copper tail.

**WATER CONNECTIONS DHW**

1. Fit the DHW inlet service valve (blue handle) and copper tail to the threaded boss connection ensuring the seal provided is correctly located.
2. Fit the DHW outlet pipe tail to DHW outlet connection, ensuring the seal provided is correctly located.
3. Fit the filling loop provided between the DHW inlet valve and the CH return valve.

**GAS CONNECTION**

**IMPORTANT:** The gas service cock is sealed with a non-metallic blue fibre washer, which must not be overheated when making capillary connections. Refer to Section 1.16 for details of the position of the gas connection.

For additional gas supply info refer to "Gas Supply" on page 10.

**SAFETY VALVE DRAIN**

The safety valve connection, located at the bottom right-hand side of the boiler, comprises a 15 mm diameter stub pipe.

The Installer to provide a compression joint on the end of the stub pipe. This assists with pipe removal when servicing.

**Note:** The domestic hot water flow rate is automatically regulated to a maximum:

- 2530 C = 14.8 l/m (3.3 gpm)
- 3035 C = 16.8 l/m (3.7 gpm)
- 3540 C = 19.0 l/m (4.2 gpm)

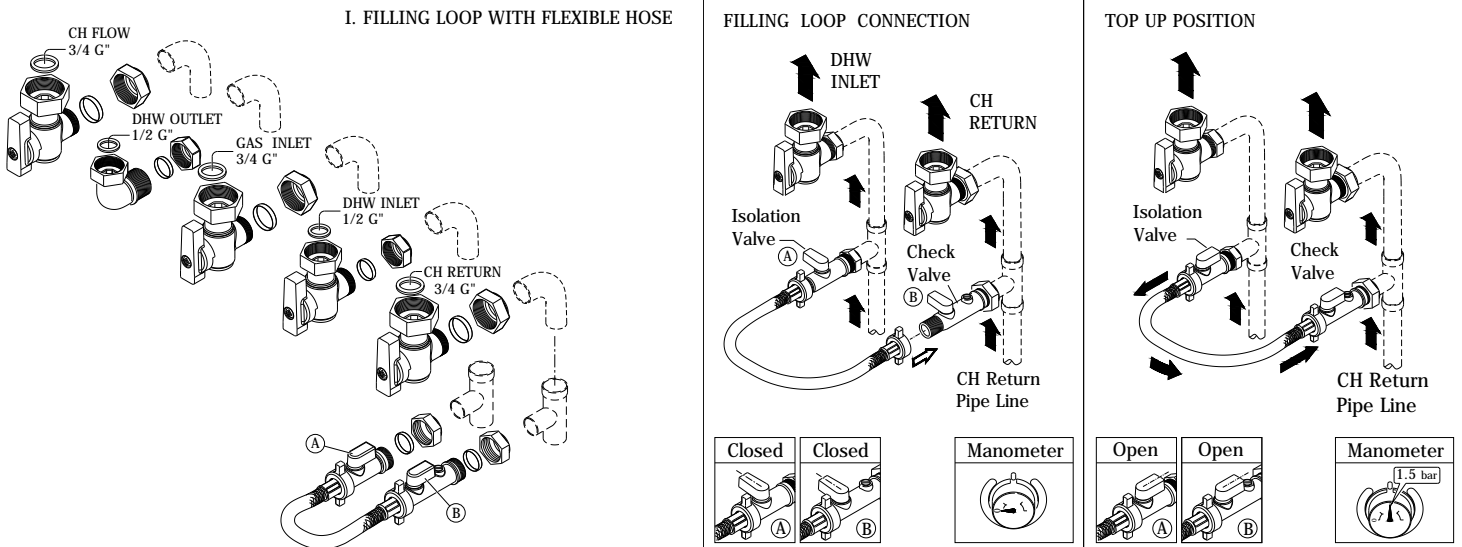

Figure 2.30 Filling-Loop Kit (OPTIONAL)

**FILLING LOOP CONNECTION**

When filling there may be a slight water leak from the air vent therefore electrical connections should be protected.

**IMPORTANT:** when the filling there may be a slight water leak from the air vent therefore electrical connections should be protected.

**Warning:** Do not add cold water into the boiler when it is hot. To correct filling up, turn off the boiler and wait until the temperature drops under 40 °C and the radiators seem cold before filling the heating system.

- I. Filling loop with flexible hose (Optional)
- II. Filling loop with straight pipe (Optional)

**FILLING LOOP CONNECTION (System A)**

1. Remove the dust cap and connect to flexible hose to the check valve securely.
2. Slowly turn the both valves (A and B) to the **Open** position until the pressure gauge reads between 1.2 and 1.5 bar.
3. Turn the both valves slowly (A and B) to the **Close** position and check the pressure in between 1.2 and 1.5 bar if pressure less than 1.2 bar then.
4. Slowly turn the both valves (A and B) to the **Open** position until the pressure gauge reads between 1.2 and 1.5 bar.
5. Turn the both valves slowly (A and B) to the **Close** position and disconnected the flexible hose from the check valve.
6. Fit the dust cap to the open and make sure no water leakage from valves or caps.

**NOTE:** If loss of pressure problem persists you must contact your installer or service company.

**FILLING LOOP CONNECTION (System B)**

1. Turn the DHW valve knob (E) counter clockwise slowly to open position.
2. Turn the CH Inlet valve knob (F) counter clockwise slowly and look at the pressure gauge (manometer) reads between 1.2 to 1.5 bar.
3. Turn the CH Inlet valve knob (F) slowly to the **Close** position and check the pressure in between 1.2 and 1.5 bar if pressure less than 1.2 bar then.
4. Turn the CH Inlet valve knob (F) counter clockwise slowly and look at the pressure gauge (manometer) reads between 1.2 to 1.5 bar.
5. Turn the both valves (E and F) to clockwise to closed position and make sure no water leakage from valves.

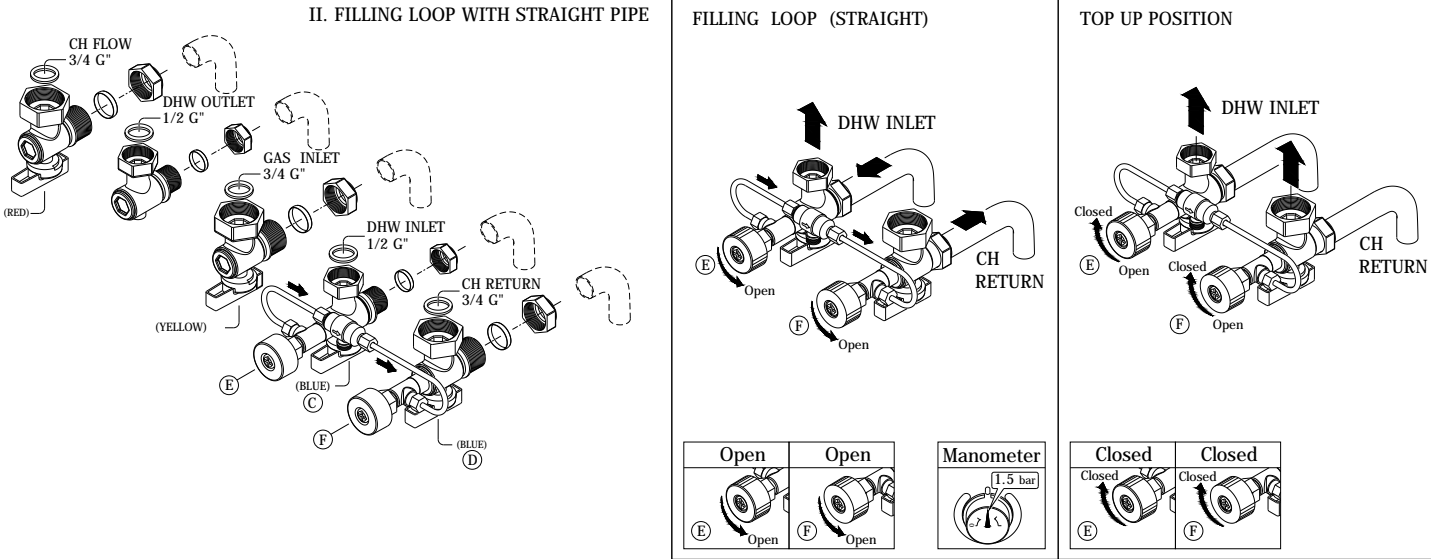

Figure 2.31

## 2.14 Electrical Connections

### WARNING:

This appliance **MUST** be earthed.

A mains supply of 230Vac ~ 50 Hz is required.

The fuse rating should be 2A. All external controls and wiring must be suitable for mains voltage.

Wiring external to the boiler **MUST** be in accordance with the current I.E.E. (BS.7671) Wiring Regulations and any local regulations.

Wiring should be 3 core PVC insulated cable, not less than 0.75 mm<sup>2</sup> (24 x 0.2 mm), and to BS 6500 Table 16. For IE reference should be made to the current ETCI rules for electrical installations.

Connection must be made in a way that allows complete isolation of the electrical supply such as a double pole switch having a 3 mm contact separation in both poles. The means of isolation must be accessible to the user after installation.

## 2.15 Internal Wiring

The Warmhaus Combi boiler comes pre-fitted with 1.2 m of mains cable. This must be connected to a permanent live supply and **NOT** switched by thermostats/programmers. For installers wishing to change this cable refer to "Replacing Pre-fitted Mains Cable". The Warmhaus Combi boiler comes pre-fitted with a link wire between the room thermostat/timer connections on the terminal strip. This creates a permanent call for heat and must be removed when adding a room thermostat/programmer. The terminal block cover carries two spare fuses for the main PCB.

To add thermostat/programmer:

1. Isolate the mains supply to the boiler.
2. Remove the front panel.
3. Swing the control box down into the servicing position. Refer to Figure 2.32
4. Route incoming cables through the grommets in bottom panel (note, grommets are 'blind' and will require puncturing) and secure using clamps and screws provided in hardware pack.
5. Pull off rubber terminal block cover.
6. Connect wires to terminal block, as shown below
7. Re-assemble in reverse order.

### INSTALLER CONNECTIONS (LHS)

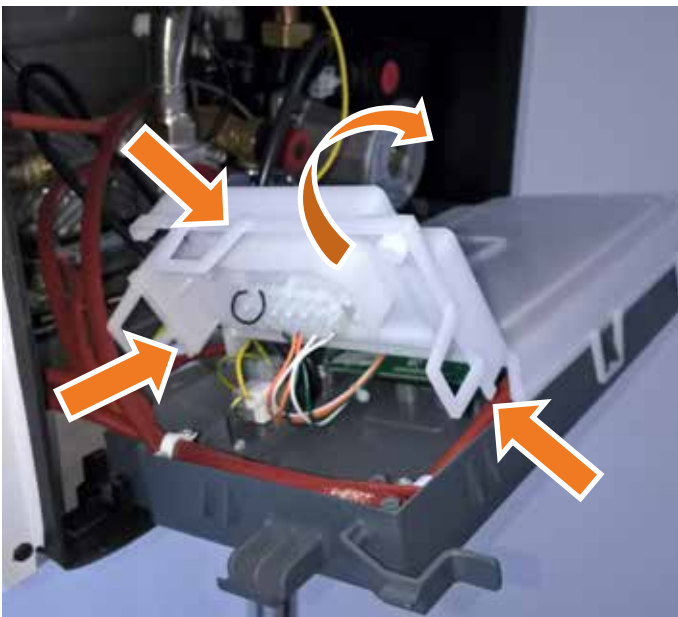

Figure 2.32

### INSTALLER CONNECTIONS (RHS)

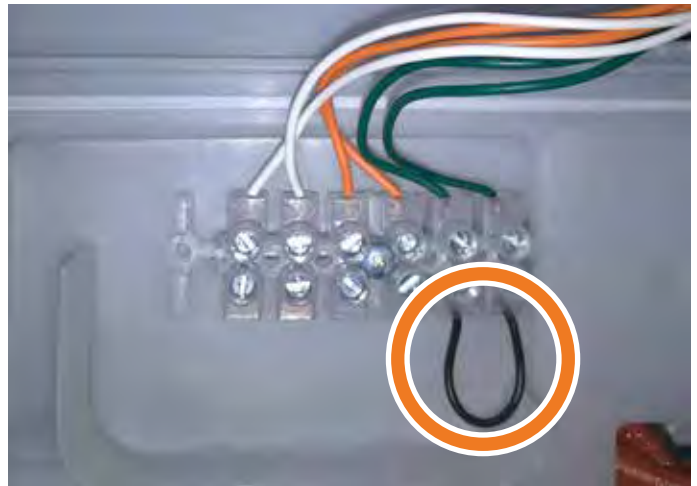

Figure 2.33

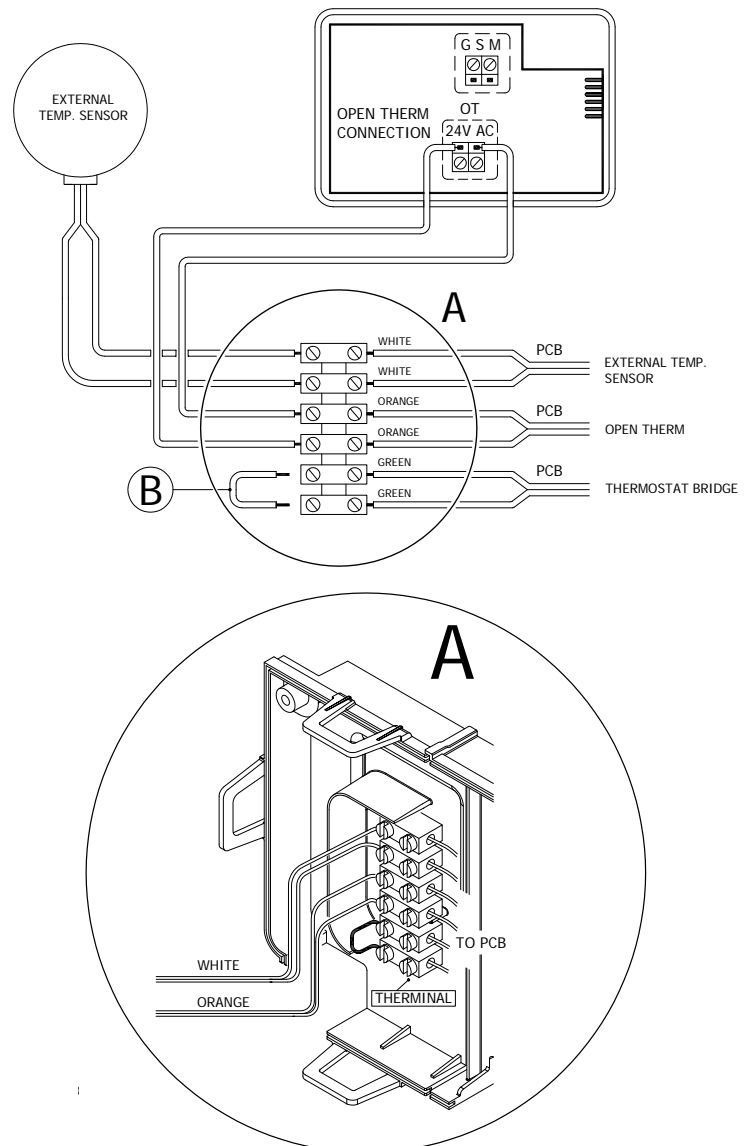

Figure 2.34



**REMOVE THE BRIDGE WIRE FROM THE ROOM THERMOSTAT/TIMER TERMINAL**

**(B) WHEN THE TIMER OR OPEN THERM CONNECTED THE BOILER!**

**2.16 CH Operation (External Weather Temperature Sensor Use (Optional))**

External Weather Temperature Sensor (optional) can be installed in your combi by our Authorized Service (see: Installation Section; Accessory Connection Scheme), and you can enable automatic temperature adjustment for the radiator with immediate responses to external weather temperature changes via smart and comfort operation.

Therefore, it maintains an efficient and economic operation by reducing the radiator water temperature when external weather temperature increases and gradually increasing the radiator water temperature when external weather temperature decreases and sets you free from making radiator temperature adjustments. This sensor is activated when connected independently from the typology or availability of used thermostat, the relation between output temperature and external temperature is defined according to curves given in the graphic below based on position of button located on the combi panel.

After connecting the External Weather Temperature Sensor, adjustment is made according to average external weather temperature of your province with P04 parameter. Our authorized service will make this adjustment during installation. If the Central Heating Temperature Control Knob is rotated fully anti-clockwise then for an Outside

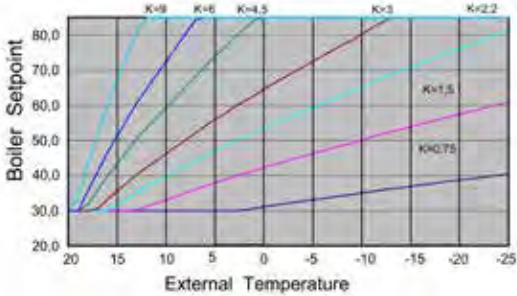

Figure 2.35 External weather temperature sensor operation curves

Temperature of 15 °C a Flow Temperature of 30 °C will be provided. For an Outside Temperature of 0 °C a Flow Temperature of 44 °C will be provided with the relationship varying linearly in between these 2 points (line on the graph 1.5).

**2.17 The Weather Compensation Kit**

This kit provides the facility to apply outside air temperature control to the boiler water flow temperature which provides energy savings. The outside sensor provided measures outside air temperature and sends a signal to the boiler, which adjusts the maximum boiler flow temperature in response. If outside air temperature is greater than the system design temperature, the boiler flow temperature is reduced providing running cost savings. The boiler will operate in the condensing mode more frequently increasing savings.

Once the sensor is fitted it is automatically detected.

The sensor operation may be configured by adjustment of the boiler operating parameters, if necessary.

**Fitting the sensor**

The air sensor should be located on an external wall of the building to be heated. Fix the sensor to a north/north-east facing wall to avoid direct radiation from the sun. The air sensor should be located to avoid any heating effect from the boiler flue.

To fix the air sensor to the wall, unscrew the sensor box plastic cover and screw/plug the sensor body to the wall.

Wire a twin core 0.5 mm<sup>2</sup> cable from the sensor to the boiler through an RH grommet located on the underside of the boiler. Cable length between sensor and boiler should be no greater than 50 m. Note that this connection is safety extra low voltage. It is not necessary for the person carrying out the wiring to be approved to Part P of the Building Regulations.

Avoid running this cable alongside mains voltage cables.

**Wiring the Weather Compensation Kit to the Warmhaus Combi.**

1. Isolate the electricity supply to the boiler.
2. Remove the boiler front panel (refer to boiler installation instructions).
3. Hinge down the control box.
4. Insert the cable through the grommet located on the terminal (see fig. 2.34).
5. Connect the sensor wiring into the RHS of the 6 way terminal block and secure with a cable clamp.
6. Re-assemble in reverse order.

**Note:** If fitting this with the boiler, then please complete product Fiche system label, adding % efficiency. This is a Class II Control (2%).



Figure 2.36

## INSTALLER CONNECTIONS (RHS)

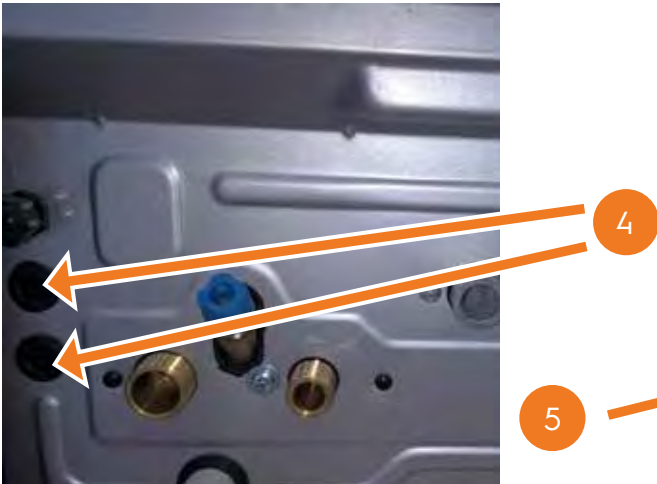

Figure 2.37

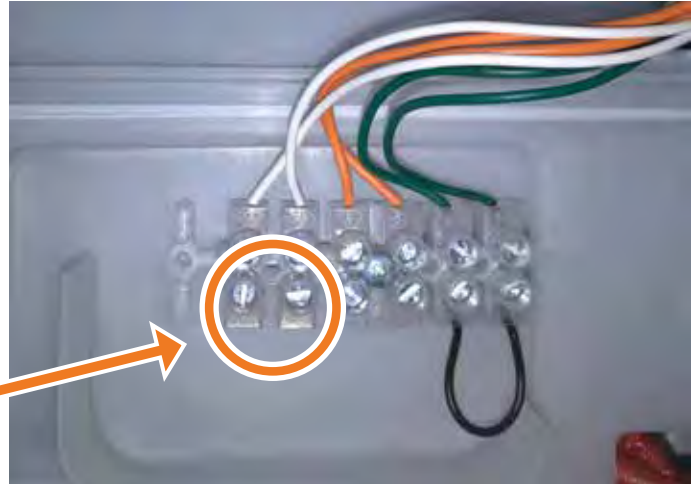

Figure 2.38

## 2.18 Commissioning And Testing

### A. Electrical Installation

1. Checks to ensure electrical safety should be carried out by a competent person.
2. ALWAYS carry out the preliminary electrical system checks, i.e. earth continuity, polarity, resistance to earth and short circuit, using a suitable test meter.

After wiring the boiler, all grommets in the bottom panel MUST be in place to ensure that the boiler case sealing is maintained.

### B. Gas Installation

1. The whole of the gas installation, including the meter, should be inspected and tested for tightness and purged in accordance with the recommendations of BS.6891. In IE refer to IS.813.
2. Purge air from the gas installation by the approved methods only and always close air purging points and seal correctly.

**WARNING. Whilst effecting the required gas tightness test and purging air from the gas installation, open all windows and doors, extinguish naked lights and DO NOT SMOKE.**

### GENERAL

**Please Note:** The combustion for this appliance has been checked, adjusted and preset at the factory for operation on the gas type defined on the appliance data plate. DO NOT adjust the air/gas ratio valve.

### Having checked:

- That the boiler has been installed in accordance with these instructions.
- The integrity of the flue system and the flue seals, as described in the Flue Installation section.

Proceed to put the boiler into operation as follows:

### CHECK THE OPERATIONAL (WORKING) GAS INLET PRESSURE

Set up the boiler to operate at maximum rate by opening hot tap to maximum flow.

With the boiler operating in the maximum rate condition check that the operational (working) gas pressure at the inlet gas pressure test point complies with the requirements - refer to "Gas Supply" (section 1.8 Gas Supply).

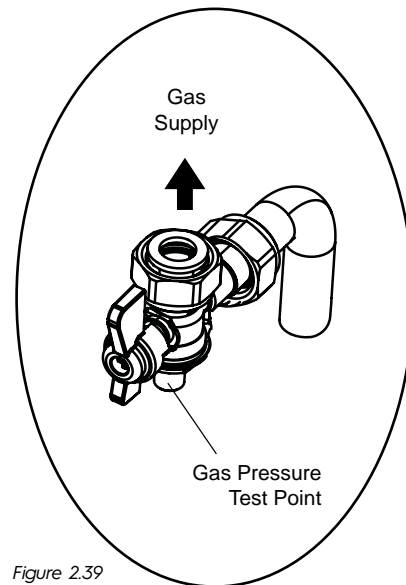

Figure 2.39

Ensure that this inlet pressure can be obtained with all other gas appliances in the property working



For "PLUS" model the Air venting function proceed as follows:

Press the Reset+DHW(-) button and wait until the cycle is completed.  
The boiler will display "AIR"



Figure 2.40

As part of the commissioning process, the combustion of this appliance must be checked and the Benchmark Checklist completed. A flow chart to assist is provided on page 73.

#### ATTENTION!

**IT IS A CONDITION OF THE MANUFACTURER'S WARRANTY THAT THE BENCHMARK COMMISSIONING CHECKLIST IS FULLY COMPLETED AND LEFT WITH THE APPLIANCE**

#### WATER CIRCULATION SYSTEM

1. With the system COLD, check that the initial pressure is correct to the system design requirements.  
For pre-pressurised systems, this should be 1.0 bar.
  2. With the system HOT, examine all water connections for soundness. The system pressure will increase with temperature rise but should not exceed 2.5 bar.
  3. With the system still hot, turn off the gas, water and electricity supplies to the boiler and drain down to complete the flushing process.
- Note:** A flushing solution should be used during the flushing procedure. Flushing solutions: Fernox Superfloc, Sentinel X300 (new systems) or X400 (existing systems). Refer to Section 1.16.
4. Refill and vent the system, add inhibitor (see Frame 5), clear all air locks and again check for water soundness.
  5. Restart the system initial pressure to the design requirement.
  6. Balance the system. Refer to Section 1.15.
  7. Check the condensate drain for leaks and check that it is discharging correctly.
  8. Finally, set the controls to the User's requirements.

#### HANDING OVER

After completing the installation and commissioning of the system the installer should hand over to the householder by the following actions:

1. Make the householder aware that the user instructions are located in the pocket in the drop down door and explain his/her responsibilities under the relevant national regulations.
2. Explain and demonstrate the lighting and shutting down procedures.
3. The operation of the boiler and the use and adjustment of all system controls should be fully explained to the householder, to ensure the greatest possible fuel economy consistent with the household requirements of both heating and hot water consumption. Advise the User of the precautions necessary to prevent damage to the system and to the building, in the event of the system remaining inoperative during frosty conditions.
4. Explain the function and the use of the boiler heating and domestic hot water controls.

Explain that due to system variations and seasonal temperature fluctuations DHW flow rates/temperature rise will vary, requiring adjustment at the draw off tap. It is therefore necessary to draw the users attention to the section in the Users Instructions titled "Control of Water Temperature" and the following statement:

"Additionally, the temperature can be controlled by the user via the draw-off tap: the lower the rate the higher the temperature, and vice versa".

**Notes:**

- 1. If the pump has not operated in the last 24 hours it will run briefly to prevent seizure.
- 2. If the diverter valve has not operated in the last 24 hours it will be operated briefly to prevent seizure. These two operations will not occur at the same time.

**WATER TEMPERATURES**

Temperatures can be selected using the CH and DHW thermostats.

Table 2.1

Knob Setting	CH Flow Temp	DHW Outlet Temp
Max	80 °C	60 °C
Min	25 °C	35 °C

Due to system variations and seasonal temperature fluctuations DHW flow rates/temperature rise will vary, requiring adjustment at the draw off tap: The lower the rate the higher the temperature, and vice versa.

- 5. Explain the function of the boiler fault mode.
- 6. Explain and demonstrate the function of time and temperature controls, radiator valves etc., for the economic use of the system.
- 7. If a timer is fitted draw attention to the timer Users Instructions and hand them to the householder.
- 8. Loss of system water pressure Explain that the dial on the boiler indicates the central heating system pressure and that if the normal COLD pressure of the system is seen to decrease over a period of time then a water leak is indicated. Explain the repress rising procedure and if unable to re-pressurize or if the pressure continues to drop a registered local heating Installer should be consulted.
- 9. Explain boiler restart procedure (refer to section 3.2 & 3.4).
- 10. After installation and commissioning please complete the Commissioning Checklist before handover to the customer. For IE, its is necessary to complete a "Declaration of Conformity" to indicate compliance to I.S. 813:2002.

**IMPORTANT**

- 11. A comprehensive service should be carried out.

**ANNUALLY.**

Stress the importance of regular servicing by a Gas Safe Registered Engineer. In IE servicing work must be carried out by a Registered Gas Installer (RGI).

- 12. Inform the householder of the guarantee form and the requirement to register it to receive the full benefit of the warranty.

# SECTION 3 USER'S SECTION

---

Priwa & Enerwa  
Priwa Plus & Enerwa Plus



### 3.1 GENERAL WARNINGS FOR USER

#### 3.1.1 Use of Combi

If a gas odour is available in the environment, close home entrance line and gas valves of your combi or close! The LPG tank valve or tube valve if bulk gas is used. Do not shut on-off electricity buttons and do not do anything those may create sparks. Call the Gas Company or Authorized Service.

#### NATIONAL GRID EMERGENCY 0800 111 999

First start should be performed by the Warmhaus Authorized Service for your safety and preventing void warranty scope. Our Authorized Service will give you required information about use of combi after performing initial controls of your combi and starting for the first time.

#### Perform below given controls prior to starting to use:

- Ensure that radiator/heating system, tap water and gas valves located under your combi are open, the radiator installation pressure is between 1-1.5 bar on the manometer located under the Combi and system air is discharged,
- Gas is available in your gas line (you can control by igniting one of your gas ovens),
- Combi electrical fuse is open,
- No flammable materials and products are available near to the Combi,
- Exhaust gas flue set output is not blocked,
- If a room thermostat or control device is connected, ensure that it is at ON position.

If you will shut-off the combi for a long period, perform below written operations:

- Discharge the radiator installation water not containing anti-freeze,
- Close combi electrical fuse, gas valve, radiator and tap water valves!, If you will shut-off the combi for a short period, perform below written operations:
- Do not close combi electrical fuse, gas valve, radiator and tap water valves!
- Leave the Combi at Summer position and activate its Frost Protection function,

Shut-off the combi during maintenance and repair operations to be performed around exhaust gas discharge flues. After operations are completed, have the combi controlled by Warmhaus Authorized Service prior to starting the combi.

#### Follow below given main rules:

- Do not clean external frame of combi while combi is functioning and do not use easily flammable materials.
- Do not hold the combi with wet hands or feet; also without shoes and with bare feet.
- Do not pick electricity cables.
- In case cables are damaged, shut-off the combi and fuse switches and do not use the combi.
- Electrical cables of combi and its accessories should have replaced by the Authorized Service.
- Do not expose the hung combi to direct vapour those may arise from cooking places.
- Prevent use of combi by children and inexperienced persons.

#### HOW TO MOVE WHEN NATURAL GAS ODOUR IS DETECTED...



Do not use lighter - matches.



Do not light on and off lamps and other electrical devices or pull off the plug.



Ventilate the environment by opening doors and windows.



Close valves of devices operating with natural gas and your gas meter.



Do not use the door bell.



Do not use phones in case of a natural gas leakage. It may create sparks.



Immediately evacuate the place with gas odour.



Natural Gas Emergency Line from your neighbour or another suitable place.



Do not make any intervention on installation.



Never close culverts ensuring discharge of the gas from the environment in case of a natural gas leakage.

#### DURING EMERGENCIES



NATIONAL GRID EMERGENCY



FIRE DEPARTMENT



AMBULANCE



POLICE

**INFORMATION:** You can visit web sites of local gas authorities and **NATURAL GAS EMERGENCY** sections.

**Advice:** Please take note local emergency phone numbers.

### 3.2 Control Panel Of Priwa And Enerwa Model Combi Devices

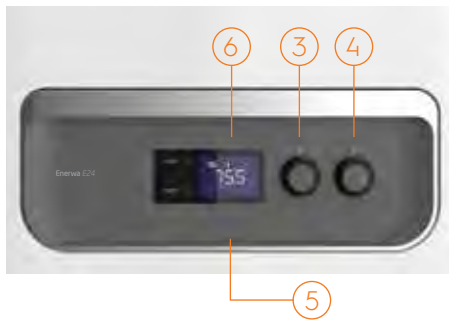

Figure 3.1 Control panel of Priwa & Enerwa combi

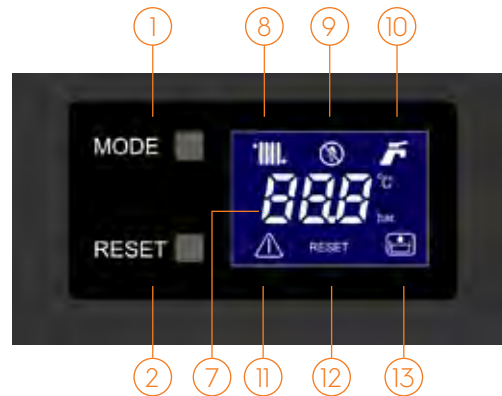

Figure 3.2 Control panel of Priwa & Enerwa combi screen



Figure 3.3

#### BUTTONS and PUSHBUTTONS

1. MODE, position adjustment button.
2. RESET button.
3. Radiator (CH) water temperature adjustment button.
4. DHW temperature adjustment button.
5. Software connection slot.
6. Digital display screen.
7. Temperature, data and failure codes display.
8. Radiator symbol is seen when combi is functioning in (CH) position. Symbol flashes at heating steps or when radiator temperature adjustment is made.
9. Flame symbol is only seen when boiler is active (burning in combi); when system detects availability of flame. It is seen as symbol in case of failure.
10. DHW tap symbol is seen at summer and/or winter position of the combi. Symbol flashes on DHW request or when DHW adjustment is made.
11. Failure indicator.
12. Failure status RESET requirement.
13. Radiator low water pressure.

The temperature value displayed on the combi screen has a  $\pm 3^{\circ}\text{C}$  tolerance depending on environmental conditions not arising from the combi.

PRIWA & ENERWA combi screens consist of navy blue coloured backlit LCD screen, 2 buttons, Radiator (3) and Hot Tap Water (4) and 2 pcs, RESET (2) and MODE (1) pushbuttons.

**RESET:** It is used for re-starting the combi and eliminating the failure in case of combi failure.

**MODE:** Winter/Summer/OFF mode is used for position adjustment.

Operating positions and related notifications:

#### POSITION EXPLANATIONS:

- CLOSED or OFF (3 digits LCD screen)
- WINTER► Radiator temperature +  $^{\circ}\text{C}$  + tap + radiator is displayed.
- SUMMER► Radiator temperature +  $^{\circ}\text{C}$  + tap is displayed.
- CH ON► Radiator Temperature +  $^{\circ}\text{C}$  + tap + flashing radiator (symbol) is displayed.
- DHW ON► DHW temperature +  $^{\circ}\text{C}$  + flashing tap (symbol) is displayed.
- CH FROST PROTECTION► Radiator temperature +  $^{\circ}\text{C}$  + flashing radiator (symbol) + when boiler is ignited flame (symbol) is displayed.
- DHW FROST PROTECTION► CH temperature +  $^{\circ}\text{C}$  flashing radiator and tap (symbol) + when boiler ignited flame (symbol)
- CH/DHW SETTING CHANGE► CH adjustment change will be activated when radiator symbol rapidly flashes. DHW adjustment change will be activated when tap symbol rapidly flashes.
- Service technician function radiator + tap displayed. (Only for authorized service, wait for the function to end without pressing any button or rotating the button in such case!)

---

CH: (System) Central Heating    DHW: Domestic Hot Water

---

### 3.3 Selection Of On/Off/Standby And Summer/Winter Modes

Use V automat switch for interrupting the electrical connection of combi. The temperature value when electricity is supplied to the device is the temperature value of water in the installation.

#### 3.3.1 On/off/standby positions



Use V automat (fuse) switch for shutting ON/OFF the electrical connection of combi.



When the combi is started for the first time, screen displays nG letter and then a number (for instance 24) indicating kW power of the device.



Then, OFF letter is displayed,



and screenlight is closed. Now, combi is at STANDBY position. The temperature value when electricity is supplied to the device is the temperature value of water in the installation.



{If you have a ground heating system, as our Authorized Service adjust your combi for “**Low Temperature Operation**”, maximum temperature shall be limited with the Radiator temperature adjustment button (3) (e.g. maximum 47 °C)}.

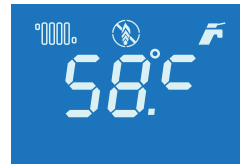

At that position, you can adjust the temperature between 35 - 60 °C with the Domestic Hot Water temperature adjustment button (4) whose symbol is displayed. When DHW button is rotated, while screen light is on if you rotate (right) clockwise, you can increase the temperature, and you can decrease the temperature when rotated counter clockwise (left).

#### 3.3.2 Operation at winter position

At that position, combi operates both for heating the environment and providing hot tap water.



Radiator temperature is adjusted with button (3) and Domestic Hot Water temperature adjustment is made with button (4) and this temperature is displayed by indicator (7) on the screen.



In order to shuton the combi, hold **MODE** button, whereas a circle starts on the screen, release the button when circle is completed.

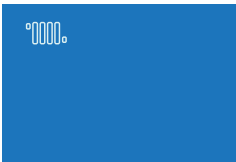

In such case, combi initially gets in the Radiator position, its symbol flashes at left top corner of screen and existing radiator installation temperature is displayed on the screen and then screen light turns off. At that position, you can adjust the temperature between 35 - 80 °C with the Radiator temperature adjustment button (3).

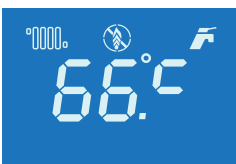

Temperature value increases when button is rotated clockwise or decreases when rotated counter clockwise. The adjusted value shall be confirmed after flashing for 4-5 seconds after releasing the button and continues to display the temperature value in the installation.



If you are starting the combi for the first time hold MODE button, and release the button after the cycle is completed on the screen, initially combi switches to radiator position, its symbol will flash on left top corner of the screen existing radiator installation temperature shall be indicated on the screen and screenlight will be turned-off.



In order to switch to DHW position, hold MODE button and release the button after completion of cycle on the screen. At that position, symbol flashes at right top corner of the screen and existing DHW temperature will be seen on the screen and screen light will turn off.



At that position, you can adjust the temperature between 35 - 60 °C with the Domestic Hot Water temperature adjustment button (4). Screen light will be open during adjustment, tap symbol and Domestic Hot Water temperature value will flash. When the DHW button is rotated, screen light turns on and temperature can be increased by rotating clockwise, and decreased by rotating counter clockwise. Adjusted temperature is indicated on the screen via the indicator (7). The value adjusted when button is released shall be approved after flashing for 4-5 seconds.

### 3.3.4 Resetting the combi (re-starting)

In cases that device gives failure/locking errors hold RESET button for 3-4 seconds, and release after completing the cycle on the screen. You can reset the device and have it repeated re-start operations



A sample utilisation error; when E81 or E06 failure codes are displayed on the device screen, it has passed to failure since no ignition occurred in your device. In that case, any of gas line valves connected to the combi may be closed, combi will be restarted when closed valve is opened and RESET button is pressed. If combi is not started with resetting, please consult our Authorized Service.

### 3.3.5 Shutting off the combi

To bring the combi to OFF position while it is in SUMMER position;

### 3.3.6 Selection of on/off/standby and summer/winter



When the MODE button is hold, after the cycle is completed while screen light is on,



screen will display OFF letter, that means your combi is OFF.



To bring combi in OFF position while it is in WINTER; hold MODE button, after cycle is completed while the screen light is on, combi will be in SUMMER position.

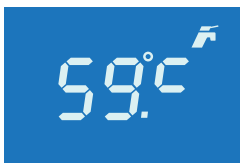

Then, upon repeating the same operation, letter will be displayed on screen after completing the cycle and screen light turns off.



Now, your combi is at STANDBY position as OFF.

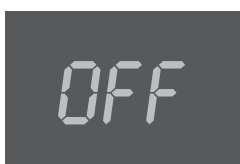

### 3.4 Control Panel Of Priwa Plus & Enerwa Plus Combi

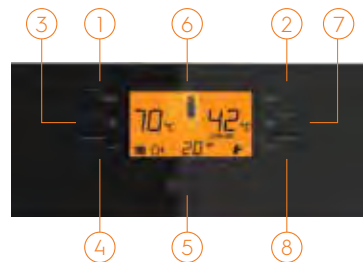

Figure 3.4 Control Panel of Priwa Plus & Enerwa Plus Combi

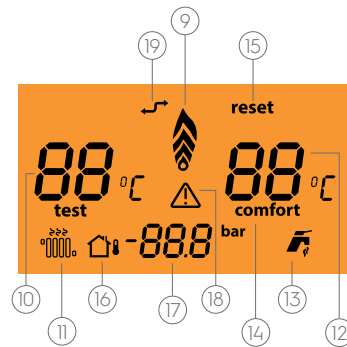

Figure 3.5 Control Panel Screen of Priwa Plus & Enerwa Plus Combi

#### 3.4.1 Buttons And Pushbuttons

1. MODE, position adjustment button.
2. RESET button.
3. Radiator (CH) temperature increasing button.
4. Radiator (CH) temperature decreasing button.
5. Software connection slot.
6. Digital display screen.
7. Domestic Hot Water temperature increasing button.
8. Domestic Hot Water temperature decreasing button.
9. Flame modulation indicator
10. Radiator (CH) water temperature.
11. Radiator (CH) mode operating indicator.
12. Domestic Hot Water temperature.
13. Domestic Hot Water operating indicator.
14. Comfort mode operation.
15. Failure status RESET requirement.
16. External Weather Temperature Sensor connection indicator
17. Digital manometer (Radiator pressure 1.3 bar warning symbol; E02 failure code is indicated if the pressure is lower than this value)
18. Failure indicator.

The temperature value displayed on the combi screen has a  $\pm 3^{\circ}\text{C}$  tolerance depending on environmental conditions not arising from the combi. Screen of Priwa Plus & Enerwa Plus combi models consist of amber coloured backlight LCD screen 6 pieces: RESET, MODE, CH (+), CH (-), DHW (+), DHW (-) pushbuttons.

**RESET:** It is used for re-starting the combi and eliminating the failure in case of combi failure.

**MODE:** Used for Winter/Summer/OFF mode adjustment.



Figure 3.6

Operating positions and related notifications:

### 3.4.2 Position explanations:

- Service technician function radiator + tap displayed. (Only for authorized service, wait for the function to end without pressing any button in such case!)
- CLOSED or OFF (3 digits LCD screen)
- WINTER► Radiator temperature + °C + tap + radiator is displayed.
- SUMMER► Radiator temperature + °C + tap is displayed.
- CH ON► Radiator Temperature + °C + tap + flashing radiator (symbol) is displayed.
- DHW ON► DHW temperature + °C + flashing tap (symbol) is displayed.
- CH FROST PROTECTION► Radiator temperature + °C + flashing radiator (symbol) + when boiler is ignited flame (symbol) is displayed.
- DHW FROST PROTECTION► CH temperature + °C flashing radiator and tap (symbol) + when boiler ignited flame (symbol).
- CH/DHW SETTING CHANGE► CH adjustment change will be activated when radiator symbol rapidly flashes. DHW adjustment change will be activated when tap symbol rapidly flashes.
- Service technician function radiator + tap displayed. (Only for authorized service, wait for the function to end without pressing any button in such case!)

### 3.4.3 Selection of on/off/standby and summer/winter modes

ON/OFF button is not available on the combi panel. Switching on/off should be performed on the V automat switch to be connected to the combi line.

### 3.4.4 On/off/standby positions

ON/OFF button is not available on the combi panel. Switching on/off should be performed on the V automat switch to be connected to the combi line.



When the combi is started for the first time, screen displays nG letter and then a number (for instance 24) indicating kW power of the device.



Then, OFF letter is displayed,



and screenlight is closed. Now, combi is at STANDBY position. The temperature value when electricity is supplied to the device is the temperature value of water in the installation.

### 3.4.5 Operation at winter position

At that position, combi operates both for heating the environment and providing Domestic Hot Water. Radiator (CH) temperature adjustment is made with (3) and (4) numbered buttons in Figure 28, Domestic Hot Water. Temperature adjustment is made with (7) and (8) numbered buttons and this temperature is indicated with (10) numbered indicator for Radiator (CH) and with (12) numbered indicator for Domestic Hot Water.



Hold the MODE button for switching on the combi when OFF letter is available on the screen.



A cycle starts on the screen.



Release the button when cycle is completed.



In such case, combi initially gets into Radiator position, its symbol flashes on the left bottom corner of screen and tap symbol is seen at right bottom corner. A digital manometer indicating the installation pressure is located at lower middle section of the screen and also existing radiator installation temperature is seen on the screen at the same time and screen light is turned off.



Analogue manometer is located near to right-bottom side of the combi. Installation pressure should be seen in this manometer even in the absence of electricity.

When combi is started, flame modulation symbol is seen at the middle section of the screen. At that position, you can increase and decrease the temperature with radiator temperature adjustment buttons (**see. Figure 3.4**) (3) between 35 – 80 °C, screen lights when buttons are pressed and °C symbol flashes besides the radiator temperature value.



{If you have a ground heating system, as our Authorized Service adjust your combi for "Low Temperature Operation", maximum temperature shall be limited with the Radiator (CH) temperature adjustment button (3) (e.g. maximum 50 °C)}.



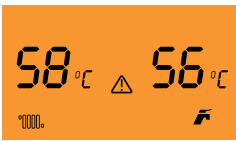

Domestic Hot Water Adjustment at Winter Position; you can adjust the hot tap water temperature value between 35 - 60 °C with (7) and (8) numbered buttons under the RESET button. Screen lights during temperature change, °C symbol flashes besides the DHW temperature value. Screen light turns off after adjustment.

### 3.4.6 Operation at summer position

Combi only operates for heating the domestic hot water at that position. In order to switch to tap water position;

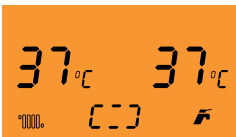

If you are starting the combi for the first time hold MODE button, and release the button after the cycle is completed on the screen, initially combi switches to radiator position, its symbol will flash on left top corner of the screen existing radiator installation temperature and screen light will turn off.

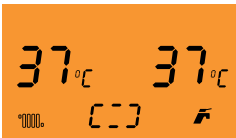

In order to switch to tap water position, hold MODE button and release the button after completion of cycle on the screen. At that position, symbol flashes at right bottom corner of the screen and existing tap water temperature will be seen on the screen and screen light will turn off.

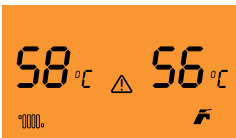

At that position, you can adjust the Domestic Hot Water temperature between 35 -60 °C with (7) and (8) numbered buttons below the RESET button.

Screen lights during temperature change, °C symbol flashes besides the DHW temperature value. Adjustment value is Confirmed after screen light turned off following the adjustment.

### 3.4.7 Shutting off the combi

To bring the combi to OFF position while it is in SUMMER position;

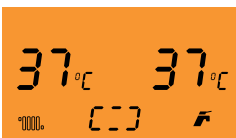

When the MODE button is hold, while screen light is on after the cycle is completed, letter seen on the screen, screen light turns off, now the combi is at OFF position.



To bring the combi to OFF position while it is in WINTER position;

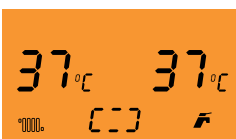

When the MODE button is hold while screen light is on after the cycle is completed, combi shall pass to SUMMER position.



Then, when the same transaction is repeated, after cycle is completed letter is seen on the screen screen light turns off, your combi is now at STANDBY position.

### 3.5 Use With Room Thermostat (Optional)

Combi has initial preparation for remote control connection via environment thermostats being sold as optional sets. All Warmhaus thermostats can be connected with dual-wired cables. Carefully read user's and installation instructions given in the Accessory set. Thanks to control units with room thermostat having program clock, you can control your combi at installation place, operating based on room temperature and also adjust different uses depending on each day of the week.



**Important:** It is compulsory to have two different lines according to legal regulations being in force regarding electrical installations in case of using a thermostat On/Off on the Remote Control. It is not allowed to use any pipe or hose of the combi as electricity or phone earthing line. That must be ensured prior to making electrical connections of the combi.

#### General Utilisation Type

- Please consult our authorized services for room thermostats compatible with Warmhaus combi.
- Do not remove device components during operation.
- Do not place at a position allowing direct sunlight exposure or near heat sources.
- Manufacturer company shall not be responsible for below given situations:
  - a) Faulty installation
  - b) Making intervention on the device by unauthorized persons
  - c) Failing to follow instructions given in this book and room thermostat booklets

**Installation Instruction:** Device installation shall only be performed by the Warmhaus Authorized Service. The dual cable required for installation is supplied by the dealer/consumer.



Room thermostat should be installed at 1,25 and 1,50 m height from ground and at least 30 cm distance.



At least 30 cm distance should be available from doors and windows open for air circulation.

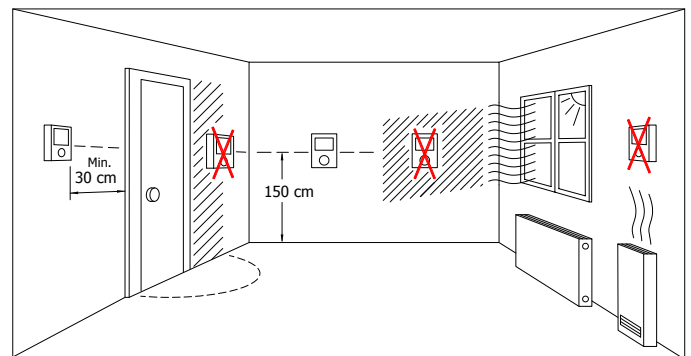

Figure 3.7 Thermostat position

Maintenance and Service Life: Warmhaus room thermostat should not come into contact with water or excessive humidity. Unless an external damage occurs, the room thermostat does not require any maintenance.

### 3.6 External Weather Temperature Sensor Use (Optional)

External Weather Temperature Sensor (optional) can be installed in your combi by our Authorized Service (see: Installation Section; Accessory Connection Scheme), and you can enable automatic temperature adjustment for the radiator with immediate responses to external weather temperature changes via smart and comfort operation. Therefore, it maintains an efficient and economic operation by reducing the radiator water temperature when external weather temperature increases and gradually increasing the radiator water temperature when external weather temperature decreases and reduces the need to making radiator temperature adjustments. This sensor is activated when connected independently from the typology or availability of thermostat used the relation between output temperature and external temperature is defined according to curves given in the graphic below based on position of button located on the combi panel.

After connecting the External Weather Temperature Sensor, adjustment is made according to average external weather temperature of your province with P04 parameter. Our authorized service will make this adjustment during installation.

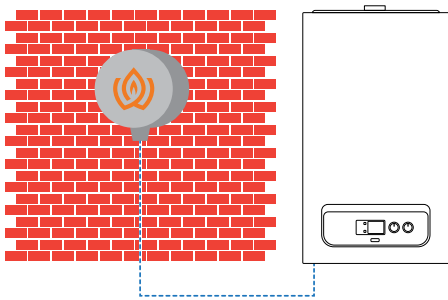

Figure 3.8 External weather temperature sensor

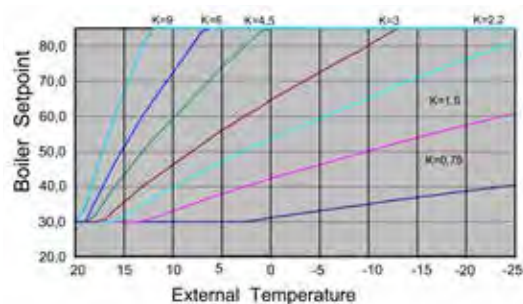

Figure 3.9 External weather temperature sensor operation curves

### 3.7 Customizing Combi Features

As your combi has an advanced electronic card, operation conditions and certain parameters related with your preferences may be changed by our Authorized Service. Please consult our authorized service when any changes requested in below given parameters.

#### (P08) Radiator (Heating) Power

Combi is equipped with an electronic modulation with power suitable with actual heat requirement of installation place. Thus, the combi automatically operates with variable gas flow rates depending on heat load of installation between the minimum and maximum power. (P07) Controlled Power Increase Period.

When combi starts, it uses a controlled period defined for reaching the adjusted maximum heating power. This period is adjusted as 3 minutes as standard and can be increased up to 3 minutes.

#### (P21) Low temperature region selection

This parameter should be adjusted as 1 for ground heating or heating systems operating with low temperature (max CH temp. 47 °C). 0 (zero) value is selected for radiator systems to operate at high temperatures as standard.

#### (P24) Child protection

This parameter is not active as standard, please consult our Authorized Service for activating the parameter (Protection lock is activated when parameter is adjusted as 1). Buttons are locked after 2 minutes following use of buttons when the function is active. Keylock is opened when the MODE button is hold until cycle is completed for getting off the child protection. Your combi is under control against setting changes upon activation of this feature.

#### (P40) Radiator ignition delay period

Combi device is equipped with an electronic timer for preventing frequent ignition by the combi during heating stage. This period is adjusted as 2 minutes as standard and can be increased up to 10 minutes.

#### (P42) Ready hot water (Pre-Heating passive/active)

In order to rapidly prepare without waiting for your hot tap water request and reducing the cold water consumption during waiting, grid water is heated in the plate exchanger and ready hot water is stored. This function can be activate by service during installation.

#### LCD Screen

Activation of this function in PRIWA and ENERWA models is performed with parametric adjustment by our Authorized Service depending on your request.

#### Air Discharge function

Activating the menu for LAWA, PRIWA and ENERWA models: Air discharge function can be activated by pressing the RESET button more than 5 seconds while CH button and DHW button are at maximum position. Upon activation of this function, 3 ways valve and pump is operated or not operated for discharging the air within the radiator installation.

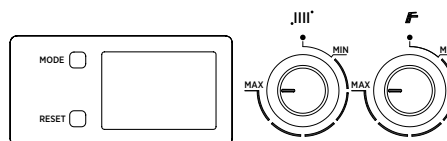

Figure 3.10 Reset and buttons MAX position

### 3.8 Troubleshooting

#### Failure Codes Table

Failure Code	Failure / Error Definition	Possible Reasons	Combi Status / Solution
rE 02	Low water pressure in heating system / system parameter is wrong adjusted	Adequate pressure is not available in the radiator installation for efficient and smooth operation of.	Control the manometer of your Combi, correct pressure value should be between 1-1.2 bar, ensure correct pressure in case of being required. Press the RESET.
E 03	High water pressure in radiator system (in Plus)	Excessive water pressure, safety valve.	Reduce the pressure from water discharge tap. Call the authorized.
E 04	DHW Temperature Sensor failure	In case the card detects failure or error in NTC tap water sensor, combi notifies this error situation.	Combi is not functioning (!).
E 05	Radiator temperature Sensor failure	Electronic card detected a failure in output NTC sensor.	Combi is not functioning (!).
E 13	Exhaust Gas Temperature Sensor excessive temperature alarm	Combi passes into failure due to excessive temperature of exhaust gas accumulated inside due to any failure during.	Call the authorized service in case of repeated after reset.
E 14	Exhaust Gas Temperature Sensor failure	Electronic card detected an anomaly in exhaust gas sensor.	Combi is not functioning (!).
E 15	Fan failure (feedback/feeding)	Fan is blocked. Excessive external air pressure.	Call the authorized service in case of repeated after reset.
rE 06 rE 08	No ignition. Not ignited within the previously defined period in case of any request for radiator or Domestic Hot Water production. Intervention may be required for removing the "ignition prevention status" at first ignition of device or after a long standby period	Control whether gas supply line valves are open. Respectively, control whether gas valves of your combi, home and building are open.	Call the authorized service in case of repeated after reset.
rE 07	Safety / Security Thermostat Intervention (dual Ca. sensor)	If internal excessive heating occurs due to any failure during normal operation, combi passes to failure status and	Press the RESET button. (!)
E 09	Waterless operation in the radiator system	Water leakage in the installation line or combi	Consult the authorized installer and/or authorized service.
E 10	AUX Output Sensor failure	Sensor failure	Call the authorized service in case of repeated after reset. (!)
E 16	AUX Return Sensor failure	Sensor failure	Call the authorized service in case of repeated after reset. (!)

Table 3.1

E 11	Gas valve modulator connection is broken.	Internal failure	Call the authorized service in case of repeated after reset. (1)
E 17	Maximum difference failure between 2 NTC temperature sensors	Inadequate circulation	Call the authorized service and installer in case of repeated after reset. (1)
E 19	Maximum difference failure between 2 NTC temperature sensors	Inadequate circulation	Call the authorized service and installer in case of repeated after reset. (1)
rE 28	Maximum locking number reached	Usable RESET number reached.	Warning: Failure can be reset successively for maximum 5 times, then function is terminated for at least one hour and one try is possible per hour provided that having maximum 5 tries. 5 attempts are available when.
E 37	Low voltage failure	Seen when the voltage required for operation of combi is under.	Combi starts again without requiring RESET after the Electrical voltage turns into normal
E 40	Electricity network frequency error	Fluctuation in electricity frequency	Call the authorized service in case of repeated after reset. (1)
rE 41	Flame loss after 6 successive ignitions	Control whether gas supply line valves are open. Respectively, control whether gas valves of your combi, home and building are	Call the authorized service in case of repeated after reset. (1)
E 42	Failure in pushbuttons	Button failure	Call the authorized service. (1)
E 43	Room thermostat (OT) communication failure	Disconnection or communication loss in room thermostat	Call the authorized service. (1)
rE 44	Failure of exceeding the gas valve opening period without flame	Occurs when the gas valve remains open longer than expected, combi continues operating for normal	Press the RESET button. (1) Make sure not too many short DHW demands within 2 min.
E 62	Calibration request	Electronic brain detects absence of calibration. Control when electronic card is replaced or will be required for changing an air and gas variation in parameters section.	It ends when calibration is completed.
rE 72	Delta T error due to failing to ignite	Gas line valves are closed or flue problem	Ensure that gas line valves are open and control flue pulse/circulation. (1)
E 74	Second Ca. Temperature Sensor failure	Sensor failure	Call the authorized service. (1)
E 77	Absolute current values reached	Make a reset, check gas pressure, Check for combustion values and CO <sub>2</sub> calibration, check for gas pressure. Perform calibration.	If not successful. Replace board, if not successful replace valve
E 78	Max regulation current value reached	Make a reset, check gas pressure, Check for combustion values and CO <sub>2</sub> calibration, check for gas pressure. Perform calibration.	If not successful. Replace board, if not successful replace valve
E 79	Min regulation current value reached	Make a reset, check gas pressure, Check for combustion values and CO <sub>2</sub> calibration, check for gas pressure. Perform calibration.	If not successful. Replace board, if not successful replace valve
rE 80	Gas valve driver failure	Internal failure	Call the authorized service. (1)
rE 81	Ignition problem at first start (1, 2)	Problem in the flue line. Check flue blockage chimney gaskets.	Call the authorized service. (1)
rE 82	Burning problem failure		
E 83	Temporary mis-burning failure	Gas pressure and/or flue line problem	Have the gas pressure and flue line controlled. (1)
E 84	Capacity reduction for detected (supposed) low gas inlet pressure	Check inlet pressure, check CO <sub>2</sub> calibration values	Call the authorized service. (1)
rE 88	Failure in gas line cycle	A failure is detected in gas valve components.	Combi is not functioning (1).
E 89	Problem on combustion feedback signal	Check gas pressure	Call the authorized service. (1)

E 90	Unable to regulate combustion	Check calibration values, chimney, gas valve, board	Call the authorized service. (1)
E 92	Air compensation active	Check for CO <sub>2</sub> values, possible wind presence, Could be a solution to increase min E owed capacity (with the related parameter)	Call the authorized service. (1)
E 93	Unable to regulate combustion (temporarily)	To check calibration values, chimney, gas valve, board	Call the authorized service. (1)
E 94	Possible low gas pressure or exhaust recirculation	Check Gas pressure Check flue gas pipe gaskets	Call the authorized service. (1)
E 95	Intermittent combustion value	Check electrode position, electrical connection stability (intermittent connection)	Call the authorized service. (1)
E 96	Flue blockage	Check for chimney and combustion values, if ok perform calibration	Call the authorized service. (1)
rE 80	Gas valve failure	Internal failure	Call the authorized service. (1)
rE 81	Ignition problem at first start (1,2)	Problem in the flue line	Call the authorized service. (1)
rE 82	Burning problem failure		
E 83	Temporary mis-burning failure	Gas pressure and/or flue line problem	Have the gas pressure and flue line controlled. (1)
rE 88	Failure in gas line cycle	A failure is detected in gas valve components.	Combi is not functioning (1).
rE 98	Electronic card start (first start) failure	Internal failure	Call the authorized service. (1)
rE 99	General failure	An error is detected in the combi.	Press the RESET button. (1)

(1) Call the Authorized Service if failure continues.

(2) 81 numbered failure corresponds any blocking in the exhaust gas pipe.

In such case, you should consult the authorized service technician before re-starting the combi.

### 3.9 Recommendations For Economical Use Of Combi

Your combi is adjusted at ECO mode for economic use, we recommend not to change.

#### Correct Capacity Selection

Heat loss calculation of the combi location should be made correctly and combi capacity should comply with this calculation. Devices not having adequate capacity shall give late responses to heating requests, devices with higher capacity may require fuel consumption as they more frequently opened and closed. Therefore, combi capacities should be selected according to the place used.

#### Insulation

Insulation of your building is the most important item reducing the heat loss and gas consumption. However, as your combi has the highest thickness insulation of its class, heat loss is minimized.

#### Radiators

Ensure balancing our pressure distribution of your radiator installation within the house by making reduction adjustments from radiator valves. Placing furniture in front of radiators prevents air circulation and causes discomfort and more fuel consumption. Reducing radiator valves of rooms not used for a long period or if thermostatic radiator valve is used, bringing to the lowest position then, closing room doors will provide saving.

#### Domestic Hot Water

Always adjust the domestic hot water temperature as (38-42 °C). Adjustment of temperature adjuster as low ensures a considerable power saving. In addition, high domestic hot water temperatures cause

strong calcification and that negatively affects operation of the device (for instance, longer heating periods, less flow rate).

#### Thermostatic Radiator Valves

You can both acquire savings and comfort by balancing the heat distribution among the house by using Thermostatic Radiator Valves.

#### Room Thermostats

Your combi will operate more economically as you will have the chance to adjust requested room temperature according to comfort and economy timings via room thermostats. Thus, you can adjust temperature of your room as you wish, and also you can acquire approximately 6% power saving with every degree of temperature decrease.

#### Ventilation

Do not leave windows slightly open for ventilating room/rooms. In such case, continuous heat loss will occur and not having any certain improvement in the room air.

#### Fully opening windows for a short period provides a better result.

Bring thermostatic radiator valves to lowest position when ventilating rooms.

#### Cleaning And Maintenance

Attention: to preserve the boiler's integrity and keep the safety features, performance and reliability, which distinguish it, unchanged over time, you must at least execute maintenance operations on a yearly basis in compliance with what is stated in the relative point at "annual check and maintenance of the appliance", in compliance with

national, regional, or local standards in force.

We recommend stipulating a yearly cleaning and maintenance contract with an authorized local firm.

### 3.10 Issues Required To Be Taken Into Consideration For Warranty Conditions

This warranty given by Warmhaus does not cover elimination of failures arising from abnormal use of the product and also out of the warranty scope for below given situations:

1. Damages and failures occurring in devices which are not first started by Warmhaus Authorized Services,
2. Damages and failures arising from use of the product contrary to items given in User's Manual and using out of its intended purpose.
3. Damages and failures arising from wrong type selection,
4. Damages and failures arising from maintenance and repairs performed by persons other than our Authorized Services,
5. Damages and failures occurring due to transportation, unloading, loading, storing, external physical (Crushing, scratches, fractures) and chemical factors following delivery of the Product,
6. Damages and failures arising from fire and lightning,
7. Damages and failures arising from false fuel use and fuel characteristics,
8. Low or excessive voltage; unearthed socket usage;
9. Damages and failures arising from faulty electricity installations,
10. Damages and failures arising from failing to perform timely annual maintenance
11. And cleaning, defined periodical maintenance operations by our Authorized Services,
12. Damages and failures those may occur in the device or usage area due to other products and accessories used in a system with the device subject to the Warranty,
13. Damages and failures arising from frost/icing or occurring due to using in the outdoor places (open balcony, etc.).
14. Altering the Registry Label and Warranty Certificate,
15. Damages and failures arising from using water out of the water values defined in device user's guide,

Elimination of above mentioned failures shall be performed against payment. Our distinguished customer, we believe the importance of providing good products to you as well as rendering good services.

#### Recommendations and Data to be Followed:

1. When first start of your combi is done, please keep the technical service document given by the Authorized Service and a copy of device invoice and the Warranty Document approved by your **Authorized Dealer**.
2. Use your product according to principles of installation and operation guide.
3. Keep the "SERVICE DOCUMENT" if received from your service technician following the service taken. The Service Document will be beneficial for you in any problems those may occur in your device in the future.

#### Thermostatic Radiator Valves

You can both acquire savings and comfort by balancing the heat distribution among the house by using Thermostatic Radiator Valves.

#### Room Thermostats

Your combi will operate more economically as you will have the chance to adjust requested room temperature according to comfort and economy timings via room thermostats. Thus, you can adjust temperature of your room as you wish, and also you can acquire approximately 6% power saving with every degree of temperature decrease.

#### Ventilation

Do not leave windows slightly open for ventilating room/rooms. In such case, continuous heat loss will occur and not having any certain improvement in the room air.

Fully opening windows for a short period provides a better result.

Bring thermostatic radiator valves to lowest position when ventilating rooms.

#### Cleaning and Maintenance

Attention: to preserve the boiler's integrity and keep the safety features, performance and reliability, which distinguish it, unchanged over time, you must at least execute maintenance operations on a yearly basis in compliance with what is stated in the relative point at "annual check and maintenance of the appliance", in compliance with national, regional, or local standards in force.

We recommend stipulating a yearly cleaning and maintenance contract with an authorized local firm.

### 3.11 Issues Required To Be Taken Into Consideration For Warranty Conditions

This warranty given by Warmhaus does not cover elimination of failures arising from abnormal use of the product and also out of the warranty scope for below given situations:

1. Damages and failures occurring in devices which are not first started by Warmhaus Authorized Services,
2. Damages and failures arising from use of the product contrary to items given in User's Manual and using out of its intended purpose.
3. Damages and failures arising from wrong type selection,
4. Damages and failures arising from maintenance and repairs performed by persons other than our Authorized Services,
5. Damages and failures occurring due to transportation, unloading, loading, storing, external physical (Crushing, scratches, fractures) and chemical factors following delivery of the Product,
6. Damages and failures arising from fire and lightning,
7. Damages and failures arising from false fuel use and fuel characteristics,
8. Low or excessive voltage; unearthed socket usage;
9. Damages and failures arising from faulty electricity installations,
10. Damages and failures arising from failing to perform timely annual maintenance
11. And cleaning, defined periodical maintenance operations by our Authorized Services,
12. Damages and failures those may occur in the device or usage area due to other products and accessories used in a system with the device subject to the Warranty,
13. Damages and failures arising from frost/icing or occurring due to using in the outdoor places (open balcony, etc.).
14. Altering the Registry Label and Warranty Certificate,
15. Damages and failures arising from using water out of the water values defined in device user's guide,

Elimination of above mentioned failures shall be performed against payment.

Our distinguished customer, we believe the importance of providing good products to you as well as rendering good services.

#### Recommendations and Data to be Followed:

1. When first start of your combi is done, please keep the technical service document given by the Authorized Service and a copy of device invoice and the Warranty Document approved by your **Authorized Dealer**.
2. Use your product according to principles of installation and operation guide.
3. Keep the "SERVICE DOCUMENT" if received from your service technician following the service undertaken. The Service Document will be beneficial for you in any problems those may occur in your device in the future.

# SECTION 4

# TECHNICIAN & SERVICING

---

Priwa & Enerwa  
Priwa Plus & Enerwa Plus  
Service Manual





## 4.1 Parts Comprising The Combi

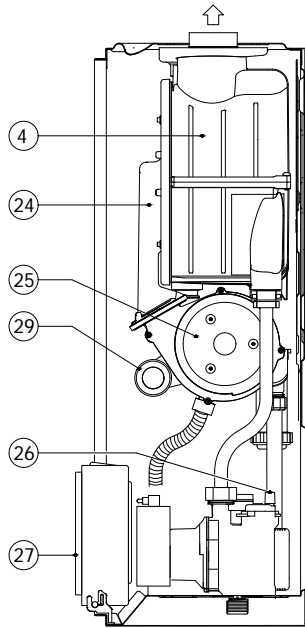
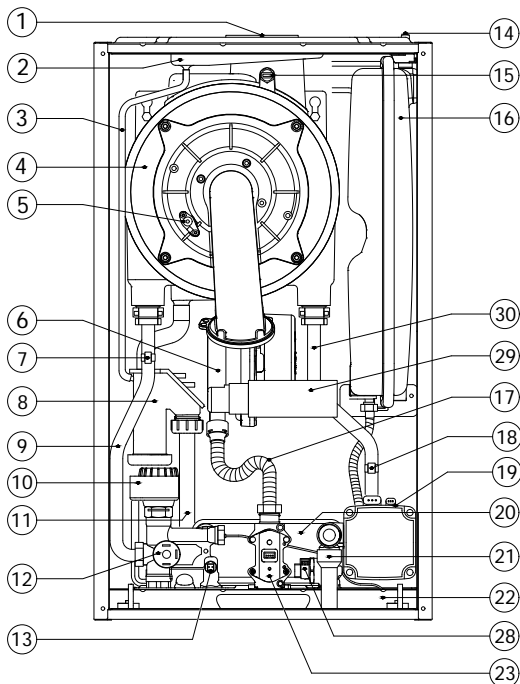

1. Flue Outlet
2. Flue condensation Pan
3. Condensation Water Discharge Hose
4. Main Heat Exchanger
5. Ignition Electrode
6. Air gas Mixing Unit (AGM)
7. CH Flow NTC Sensor
8. Condensation Water Trap (Siphon)
9. CH Outlet (Flow) Pipe
10. 3-Way Motorized Valve
11. Condensation water Discharge Hose
12. Low Pressure switch
13. DHW NTC Sensor
14. Expansion Tank Air Valve
15. Flue Gas NTC Sensor
16. Expansion Valve
17. Gas Inlet Pipe
18. CH Return NTC Sensor
19. Frequency Control Pump
20. DHW Plate Heat Exchanger
21. 3-Bar safety Valve
22. Manometer
23. Gas valve
24. Heat Exchanger Door
25. Electronic Fan
26. Automatic Air Relief Valve
27. Control Panel
28. Tap Water Flow Sensor
29. Sincer
30. CH Inlet (Return) Pipe

Figure 4.1

## 4.2 Boiler Front Panel Removal / Replacement

### Removal

1. Loosen the two screws retaining the front panel.
2. Pull panel forward and upward and remove.

### Replacement

3. Hook the panel onto the top retaining clips.
4. Push the panel ensuring that the plastic panel is in right position and centered.
5. Re-tighten the two retaining screws.

1

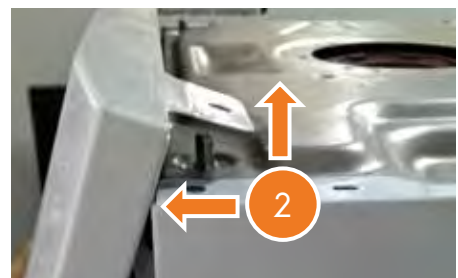



3



Figure 4.2

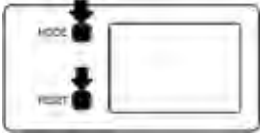
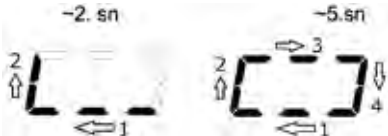
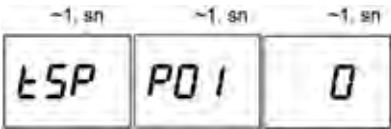
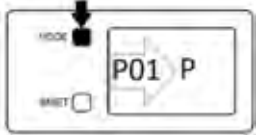
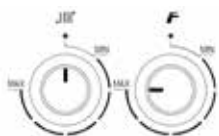
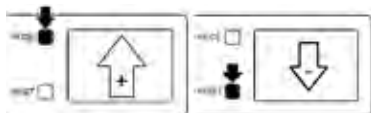
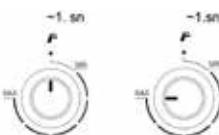

## 4.3 Set Transparent Parameters Menu (Tsp)

SET Transparent Parameters Menu (TSP)		
Designation: Lawa / Priwa / Enerwa wall-hung boilers		
Object		Type-model / Technical data
Procedure setting or checking TsP parameters		Lawa 24-28 / Priwa 24-28-33 / Enerwa 24-28-33
Pos No	Operation	Description GB
0		<b>Attention:</b> This procedure must be applied by authorized persons and valid for only condensing boiler. <b>Attention:</b> The parameters as indicated DO NOT CHANGE should not be adjusted / touched by any official document supplied by Warmhaus R&D.
1		Set both knobs at MIN position
2		Push two button MODE + RESET simultaneously
3		Wait until the approval circle complete on the LCD and release buttons
4		The screen will appear tSP - P01 – 0 <b>Attention:</b> Do not change this parameter
5		From this moment toggle MODE ( + ) to increase or RESET ( - ) to decrease any parameter aimed to be changed
6		Ones you reach the parameter aimed to be changed, on the screen turn the DHW knob to MAX position
7		Now you are able to change the parameter. Toggle MODE ( + ) to increase or RESET ( - ) to decrease to SET PARAMETER VALUE
8		Ones you reach desired value PXX = Y move DHW knob at MIN position and then after MAX position (SWING)





9		<p>The value you set on the screen will flashing after this SWING. Ones the flashing stop the value is SAVED.</p>
10		<p>Move the DHW button at MIN position</p>
11		<p>At this point on the screen shows; for example = TsP – P02 – 0</p>
12		<p>Make sure both knobs at MIN position</p>
13		<p>Push two button MODE + RESET simultaneously</p>
14		<p>Wait until the approval circle complete on the LCD and release buttons. In this way EXIT the TsP Menu.</p>
15		<p><b>Attention:</b> If parameter P14 set as 5 for Au-To calibration, if the electricity cut OFF / ON - OR wait longer time than 3 minute the P14 will be reset automatically to = 0 so please make calibration just after exit of TsP</p>
<p>Author: İsmail B. Taşdemir / R&amp;D Manager  Release date: 4/20/2017  Rev. No: 0  Drw. No: WH.17.061</p>		

Table 4.1 Procedure WH.17.061



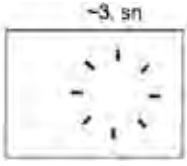

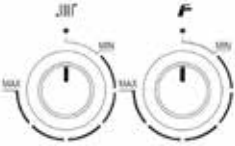
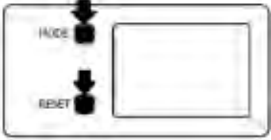
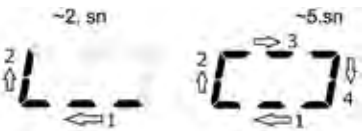



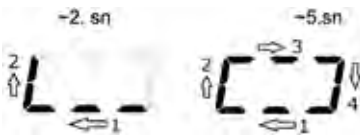

SET Transparent Parameters Menu (TSP)		
Designation: Lawa Plus / Priwa Plus / Enerwa Plus wall-hung boilers		
Object		Type-model / Technical data
Procedure setting or checking TsP parameters		Lawa Plus 24-28 / Priwa Plus 24-28-33 / Enerwa Plus 24-28-33
Pos No	Operation	Description GB
0		<b>Attention:</b> This procedure must be applied by authorized persons and valid for only condensing boiler. <b>Attention:</b> The parameters as indicated DO NOT CHANGE should not be adjusted / touched by any official document supplied by Warmhaus R&D.
1		Press the RESET and CH (-) button simultaneously
2		Wait until the approval circle complete on the LCD and release buttons
3		The screen will appear tSP - Parameter = 01 - Value = 0 <b>Attention:</b> Do not change this parameter
4		From this moment toggle CH (+) to increase or CH (-) to decrease any parameter aimed to be changed
5		Ones you reach the parameter aimed to be changed, Change the parameter VALUE by using the DHW (+) or DHW (-) buttons
6		Push the RESET button to save the adjusted value. Wait until the approval circle complete on the LCD and release button.
7		To exit the TSP menu push the RESET and CH (-) simultaneously.
8		Wait until the approval circle complete on the LCD and release buttons. In this way EXIT the TsP Menu
9		<b>Attention:</b> If parameter P14 set as 5 for Au-To calibration, if the electricity cut OFF / ON - OR wait longer time than 3 minute the P14 will be reset automatically to = 0 so please make calibration just after exit of TsP
Author: İsmail B. Taşdemir / R&D Manager		
Release date: 4/20/2017		
Rev. No: 0		
Draw. No: WH.17.061		

Table 4.2 Procedure WH.17.062

## 4.4 Parameters List

Transparent Parameters Menu (TSP) / Revision. 02 - Rel. 20.04.2017

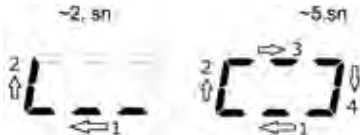
Designation: All Warmhaus Wall-Hung Boilers

Object		Manufacturer	Type-model(s)	
Burner Control Transparent Parameter List		BERTELLI	HDIMSG30-CK01 (17145) / HDIMSG30-CK02 (17153) / HAGC30-CK01 (17144.01) / HAGC30-CK02 (17144.01)	
Parameter no	Parameter	Type of Parameter	Value Field	Priwa 24 Default
P01	<b>Hydraulic system</b>	ATMO & PREMIX	0 – 8	0
	0 = Instantaneous			
	1 = Thermostat storage tank			
	2 = Not Used			
P02	<b>Gas type</b>	ATMO & PREMIX	0 – 1	0 = NG
	0 = Natural gas			1 = LPG
	1 = LPG			
P03	<b>DHW inlet configuration</b>	ATMO & PREMIX	0 – 1	1
	0 = Flow switch			
	1 = Flow meter			
P04	KT coefficient for regulation with EXT probe	ATMO & PREMIX	4 - 90	30
P05	Anti-fast cycles time (value 1 = 1 minute)	ATMO & PREMIX	0 - 10 min (dak)	3
P06	Maximum CH power	ATMO	0 % - 100 %	N/A
P07	Ignition heating ramp time (value 1 = 10 seconds)	ATMO & PREMIX	0 - 80	18
P08	Maximum CH power	PREMIX	P10 - 100 %	80
P09	Maximum DHW power	PREMIX	P10 - 100 %	100
P10	Minimum power	ATMO & PREMIX	0 % - P09	0
P11	CH Minimum temperature set point value (C°)	ATMO & PREMIX	20 C° - P12	25
P12	CH Maximum temperature set point value (C°)	ATMO & PREMIX	P11 - 85 C°	80
P13	DHW maximum temperature set point value (C°)	ATMO & PREMIX	35 C° - 65 C°	60
P14	Type of calibration	ATMO & PREMIX	0 - 20	0
	0 = Manuel calibration / ma - nu			
	5 = Auto calibration / Au - To			
P15	Selection of boiler power	PREMIX	0 - 8	0
	0 = 24 kw			
	1 = 28 kw			
	2 = 33 kw			
	3 = 45 kw			
	4 = 65 kw			
	5 = 24n kw - New Burner			
	6 = 25n kw (equal to 5 only visualitation 25n)			
	7 = 30n kw (equal to 1 only visualitation 30n)			
8 = 35n kw (equal to 2 only visualitation 35n)				
P16	Combustion configuration - DO NOT CHANGE!	ATMO	0 – 1	N/A
	0 = Closed combustion chamber with combustion control			
	1 = Open combustion chamber with flue thermostat			
P17	Climatic zone selection	ATMO & PREMIX	1..81	34
P18	CH comfort selection;	ATMO & PREMIX	0 - 2	0
	0 = Eco (if the Pre Heat will be used in the boiler Eco should be SET on the TsP.)			
	1 = Comfort (if this adjusted on TsP, then Pre Heat Function is will not work)			
P19	Exhaust measurement configuration	PREMIX	0 -1	1
	0 = Flue thermostat			
	1 = Flue NTC			
P20	Minimum value for DHW set point (C°)	ATMO & PREMIX	35 C° - 50 C°	35
P21	Low temperature zone selection	ATMO & PREMIX	0 -1	0
	0 = Low temperature disabled			
	1 = Low temperature enabled / Max CH temperature 47°C			
P22	Flues gas pipe length (value 1 = 1 meter)	ATMO & PREMIX	1 - 10	1
P23	Cycling time pump activation - cold zone (value 1 = 1 minute)	ATMO & PREMIX	1 - 10	0

						Upload			Mark (s) of conformity	
						%100 Uploaded EOLTest Stations			granted by WARMHAUS	
Priwa Plus 24 Default	Enerwa 24 Default	Enerwa Plus 24 Default	Priwa 28 Default	Priwa Plus 28 Default	Enerwa 28 Default	Enerwa Plus 28 Default	Priwa 33 Default	Priwa Plus 33 Default	Enerwa 33 Default	Enerwa Plus 33 Default
0	0	0	0	0	0	0	0	0	0	0
0 = NG	0 = NG	0 = NG	0 = NG	0 = NG	0 = NG	0 = NG	0 = NG	0 = NG	0 = NG	0 = NG
1 = LPG	1 = LPG	1 = LPG	1 = LPG	1 = LPG	1 = LPG	1 = LPG	1 = LPG	1 = LPG	1 = LPG	1 = LPG
1	1	1	1	1	1	1	1	1	1	1
30	30	30	30	30	30	30	30	30	30	30
3	3	3	3	3	3	3	3	3	3	3
N/A	N/A	N/A	N/A	N/A	N/A	N/A	N/A	N/A	N/A	N/A
18	18	18	18	18	18	18	18	18	18	18
80	80	80	80	80	80	80	82	82	82	82
100	100	100	100	100	100	100	100	100	100	100
0	0	0	0	0	0	0	0	0	0	0
25	25	25	25	25	25	25	25	25	25	25
80	80	80	80	80	80	80	80	80	80	80
60	60	60	60	60	60	60	60	60	60	60
0	0	0	0	0	0	0	0	0	0	0
0	0	0	1	1	1	1	2	2	2	2
N/A	N/A	N/A	N/A	N/A	N/A	N/A	N/A	N/A	N/A	N/A
34	34	34	34	34	34	34	34	34	34	34
1	0	1	0	1	0	1	0	1	0	1
1	1	1	1	1	1	1	1	1	1	1
35	35	35	35	35	35	35	35	35	35	35
0	0	0	0	0	0	0	0	0	0	0
1	1	1	1	1	1	1	1	1	1	1
0	0	0	0	0	0	0	0	0	0	0

Object		Manufacturer	Type-model(s)	
Burner Control Transparent Parameter List		BERTELLI	HDIMSG30-CK01 (17145) / HDIMSG30-CK02 (17153) / HAGC30-CK01 (17144.01) / HAGC30-CK02 (17144.01)	
Parameter no	Parameter	Type of Parameter	Value Field	Priwa 24 Default
P24	Push button child lock protection	ATMO & PREMIX	0 - 1	0
	0 = Child lock disabled			
	1 = Child lock enabled			
P25	Altitude loss compensation parameter (value x 100 meters)	PREMIX	0 - 20	0
P26	Water hammer delay (value 1 = 1 second)	ATMO & PREMIX	0 - 3	0
P27	Pre Heat switch off temperature	ATMO & PREMIX	30 - 75	55
P28	LCD back light activation time (value 1 = 1 second)	ATMO & PREMIX	0 - 120	45
P30	Ignition power	ATMO	0 - 40	N/A
P31	Ignition fan speed (P31 x 25 rpm)	PREMIX	80 - 160	144 = NG
				144 = LPG
P32	Maximum power fan speed (P32 x 25 + 2000 rpm)	PREMIX	P33 - 255	224 = NG
				212 = LPG
P33	Minimum power fan speed (P33 x 25 rpm)	PREMIX	30 - 60	40 = NG
				40 = LPG
P36	F49 Offset	PREMIX	0 - 100	50
P37	Configuration Aux probe	ATMO & PREMIX	3 - 3	3
	3 = Return temperature NTC			
P38	Antifreezing activation temperature (C°)	ATMO & PREMIX	0 - (+10 C°)	5
P39	CH post circulation time (value 1 = 10 seconds)	ATMO & PREMIX	0 - 99 sec x 10	18
P40	Delay in the activation of CH ignition after DHW request (value 1 = 10 seconds) if Preheat adjusted time = value / 2	ATMO & PREMIX	0 - 60 sec x 10	12
P41	Sanitary modulation with Fluxmeter	ATMO & PREMIX	0 - 1	0
	0 = Disconnected			
	1 = Connected			
P42	DHW Preheat function configuration (Please check P18 first)	ATMO & PREMIX	0 - 1	0
	0 = Pre heat OFF / PrE - OFF			
	1 = Pre heat ON / PrE - On			
P43	Delay of DHW activation with solar config. (value 1 = 1 second)	ATMO & PREMIX	0 - 30 sec	0
P44	Pressure switch selection	ATMO & PREMIX	0 - 1	0
	0 = Water pressure switch			
	1 = Water pressure sensor			
P45	Antilegionella function (storage tank only)	PREMIX	54 / 55 - 80	54
	54 = Disabled			
P46	Modulating pump speed selection (optional)	PREMIX	0 - 1	0
	0 = No modulation			
	1 = Automatic modulation in range of %66 - %100			
P47	Delta temperature CH flow and return for pump modulation	ATMO & PREMIX	10 - 40	20
P48	Pump configuration	ATMO & PREMIX	0 - 1	0
	0 = Intermittent			
	1 = Continuous			
P49	OEM Menu Enabled (P49 = 49 enable read/write of following parameters)	ATMO & PREMIX	0 - 99	0

						Upload			Mark (s) of conformity	
						%100 Uploaded EOLTest Stations			granted by WARMHAUS	
Priwa Plus 24 Default	Enerwa 24 Default	Enerwa Plus 24 Default	Priwa 28 Default	Priwa Plus 28 Default	Enerwa 28 Default	Enerwa Plus 28 Default	Priwa 33 Default	Priwa Plus 33 Default	Enerwa 33 Default	Enerwa Plus 33 Default
0	0	0	0	0	0	0	0	0	0	0
0	0	0	0	0	0	0	0	0	0	0
0	0	0	0	0	0	0	0	0	0	0
55	55	55	55	55	55	55	55	55	55	55
45	45	45	45	45	45	45	45	45	45	45
N/A	N/A	N/A	N/A	N/A	N/A	N/A	N/A	N/A	N/A	N/A
144 = NG	144 = NG	144 = NG	140 = NG	140 = NG	140 = NG	140 = NG	140 = NG	140 = NG	140 = NG	140 = NG
144 = LPG	144 = LPG	144 = LPG	128 = LPG	128 = LPG	128 = LPG	128 = LPG	128 = LPG	128 = LPG	128 = LPG	128 = LPG
224 = NG	224 = NG	224 = NG	210 = NG	210 = NG	210 = NG	210 = NG	228 = NG	228 = NG	228 = NG	228 = NG
212 = LPG	212 = LPG	212 = LPG	200 = LPG	200 = LPG	200 = LPG	200 = LPG	220 = LPG	220 = LPG	220 = LPG	220 = LPG
40 = NG	40 = NG	40 = NG	43 = NG	43 = NG	43 = NG	43 = NG	44 = NG	44 = NG	44 = NG	44 = NG
40 = LPG	40 = LPG	40 = LPG	41 = LPG	41 = LPG	41 = LPG	41 = LPG	42 = LPG	42 = LPG	42 = LPG	42 = LPG
50	50	50	50	50	50	50	50	50	50	50
3	3	3	3	3	3	3	3	3	3	3
5	5	5	5	5	5	5	5	5	5	5
18	18	18	18	18	18	18	18	18	18	18
12	12	12	12	12	12	12	12	12	12	12
0	0	0	0	0	0	0	0	0	0	0
0	0	0	0	0	0	0	0	0	0	0
0	0	0	0	0	0	0	0	0	0	0
1	0	1	0	1	0	1	0	1	0	1
54	54	54	54	54	54	54	54	54	54	54
0	1	1	0	0	1	1	0	0	1	1
20	20	20	20	20	20	20	20	20	20	20
0	0	0	0	0	0	0	0	0	0	0
0	0	0	0	0	0	0	0	0	0	0

Object		Manufacturer	Type-model(s)	
Burner Control Transparent Parameter List		BERTELLI	HDIMSG30-CK01 (17145) / HDIMSG30-CK02 (17153) / HAGC30-CK01 (17144.01) / HAGC30-CK02 (17144.01)	
Parameter no	Parameter	Type of Parameter	Value Field	Priwa 24 Default
P50	Relay configuration 1 LC27	ATMO & PREMIX	0 – 8	0
	0 = Not used			
	1 = Remote alarm normally open			
	2 = Remote alarm normally close			
	3 = Zone valve			
	4 = Automatic refill valve			
	5 = Not used			
	6 = Recirculation pump			
	7 = Zone valve with OT			
8 = Not used				
P51	Relay configuration 2 LC27	ATMO & PREMIX	0 – 8	0
P52	Automatic water refill	ATMO & PREMIX	0 – 1	0
	0 = Not present			
	1 = Present			
P53	Parameter perc combustion	ATMO	0 – 30	N/A
P54	Fluxmeter value for DHW request activation (= value / 10 ( liter / minute)	ATMO & PREMIX	10-40 / 10 (lt/min)	15
P55	DHW post ventilation time (value 1 = 10 seconds)	ATMO & PREMIX	1 - 30 sec x 10	3
P56	DHW post circulation time (value 1 = 1 second)	ATMO & PREMIX	0 – 100	30
P57	Flue clapet configuration	PREMIX	0% – 10%	0
P58	Offset fan ignition phase	ATMO	0 – 20	N/A
P59	Offset Fan Low NOx	ATMO	0 – 40	N/A
P60	Offset CH turning off after ignition	ATMO & PREMIX	0 – 20	0
P61	Exhaust temperature alarm (C°)	PREMIX	20 C° – 150 C°	105
P62	Low Noise (B&P parameter)	ATMO & PREMIX	0 – 1	0
	Please CUT OFF the GAS to change this parameter			
P63	Delay in zone valve activation (value 1 = 10 seconds)	ATMO & PREMIX	0 – 99	0
P64	Fan supply reduction @min power (up to180Vac)	ATMO	0 – 15	N/A
P65	Fan selection (not use)	PREMIX	0 – 6	0
	0 = EBM			
	1 = B&P			
	2 = Not used			
	3 - 6 = Not used			
P66	DHW water flow restrictor selection	ATMO & PREMIX	0 – 4	0
	0 = No flow regulator present			
	1 = flow regulator present			
	2 - 4 = Not used			
P67	Button configuration selection;	ATMO & PREMIX	0 – 1	1
	0 = Push button only			
	1 = Turning knobs with push button			
P68	B&P parameter 1 - DO NOT CHANGE	PREMIX	0 – 255	63
P69	B&P parameter 1 - DO NOT CHANGE	PREMIX	0 – 255	1
P80	Delta TCH (slope on CH for check pump blockage) (0 = disable)	ATMO & PREMIX	0 – 20	5
	0 = Disabled			
	Value = Temperature increase C° / per second			
P81	Maximum CH temperature for burner switch off function (0 = disable)	ATMO & PREMIX	0 – 150	0
P82	Delta temperature between CH Flow & Return (0 = disable)	ATMO & PREMIX	0 – 50	23
P83	Service maintenance counter (Value = months) (0 = Disable)	ATMO & PREMIX	0...255	0
P98	Reset TSP to default value	ATMO & PREMIX	0 – 1	0
P99	Reset OEM to default value	ATMO & PREMIX	0 – 1	0
Author	Release date	Rev. No:	Drw. No:	

Table 4.3 Transparent Parameters Menu-Procedure WH.17089



						Upload			Mark (s) of conformity	
						%100 Uploaded EOLTest Stations			granted by WARMHAUS	
Priwa Plus 24 Default	Enerwa 24 Default	Enerwa Plus 24 Default	Priwa 28 Default	Priwa Plus 28 Default	Enerwa 28 Default	Enerwa Plus 28 Default	Priwa 33 Default	Priwa Plus 33 Default	Enerwa 33 Default	Enerwa Plus 33 Default
0	0	0	0	0	0	0	0	0	0	0
0	0	0	0	0	0	0	0	0	0	0
0	0	0	0	0	0	0	0	0	0	0
N/A	N/A	N/A	N/A	N/A	N/A	N/A	N/A	N/A	N/A	N/A
15	15	15	15	15	15	15	15	15	15	15
3	3	3	3	3	3	3	3	3	3	3
30	30	30	30	30	30	30	30	30	30	30
0	0	0	0	0	0	0	0	0	0	0
N/A	N/A	N/A	N/A	N/A	N/A	N/A	N/A	N/A	N/A	N/A
N/A	N/A	N/A	N/A	N/A	N/A	N/A	N/A	N/A	N/A	N/A
0	0	0	0	0	0	0	0	0	0	0
105	105	105	105	105	105	105	105	105	105	105
0	0	0	0	0	0	0	0	0	0	0
0	0	0	0	0	0	0	0	0	0	0
N/A	N/A	N/A	N/A	N/A	N/A	N/A	N/A	N/A	N/A	N/A
0	0	0	1	1	1	1	1	1	1	1
0	0	0	0	0	0	0	0	0	0	0
0	1	0	1	0	1	0	1	0	1	0
63	63	63	63	63	63	63	63	63	63	63
1	1	1	1	1	1	1	1	1	1	1
5	5	5	5	5	5	5	5	5	5	5
0	0	0	0	0	0	0	0	0	0	0
23	23	23	23	23	23	23	23	23	23	23
0	0	0	0	0	0	0	0	0	0	0
0	0	0	0	0	0	0	0	0	0	0
0	0	0	0	0	0	0	0	0	0	0

As this is the property of Warmhaus Isıtma ve Sogutma Sistemleri San. Tic. A.Ş. It must not be passed on to any person not authorized by Warmhaus Isıtma ve Sogutma Sistemleri San. Tic. A.Ş or be copied or otherwise utilized by anybody without expressed written permission.

## 4.5 Wiring Diagrams

### 4.5.1 Priwa 24 wiring diagrams

Electrical Diagram		
Designation: Priwa 24 - wall-hung boiler		
Object	Manufacturer: Type-model / Technical data	Mark (s) of conformity
Burner control	BERTELLI HAGC30-CK01 ( 17144.01 )	granted

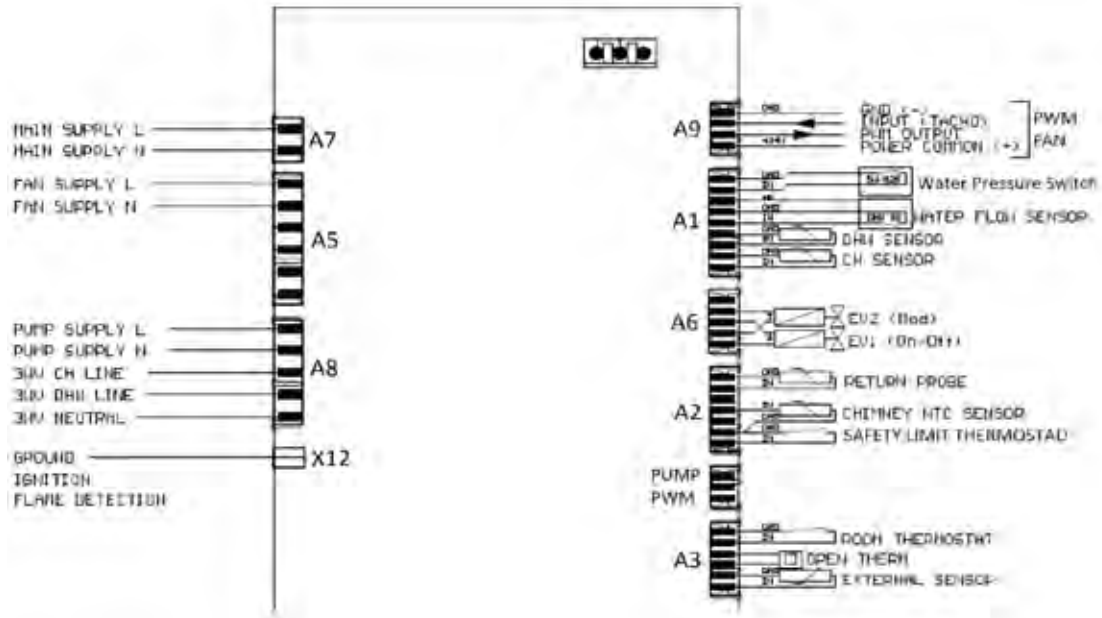

#### HIGH VOLTAGE SIDE

Plug	n.pin	Description of the pin	Notes
A5	1	L FAN	High voltage
	2	N FAN	
	3		
	4	N FUSED	
	5	L FUSED	
	6	N FUSED	
A7	1	L BOARD SUPPLY	High voltage
	2	N BOARD SUPPLY	
X12		GROUND	High voltage
A8	1	F PUMP	High voltage
	2	N PUMP	
	3	L 3 WAY VALVE CH	
	4	L 3 WAY VALVE DHW	
	5	N 3 WAY VALVE (N. O.)	
X8		SPARK & FLAME DETECTION	High voltage

#### LOW VOLTAGE SIDE

Plug	n.pin	Description of the pin	Notes
A3	1	EXTERNAL PROBE	Low voltage
	2	GND EXTERNAL PROBE	
	3	OPEN THERM	
	4	OPEN THERM	
	5	RTA ROOM THERMOSTAT	
	6	GND ROOM THERMOSTAT	
A2	1	CH2 PROBE/SAFETY LIMIT THERMOSTAT	Low voltage
	2	GND	
	3	+5V AIR PRESS SWC/FUME TRM SWC	
	4	AIR PRESS SWC	
	5	TTB	
	6	RETURN PROBE	
A1	1	CH PROBE	Low voltage
	2	GND	
	3	DHW PROBE	
	4	GND	
	5	DHW FLOW SWITCH	
	6	GND	
	7	+5V	
	8	WATER PRESS SWITCH/SENSOR	
	9	GND	
A6	1	- EV1 GAS VALVE	Low voltage
	2	- EV2 GAS VALVE (MOD)	
	3	+ EV1 GAS VALVE	
	4	+ EV2 GAS VALVE (MOD)	
	5		
A9 (Premix)	1	+24VNS	Low voltage
	2	OUT PWM F	
	3	IN FAN SPEED	
	4	GND	

Author: İsmail B. Taşdemir / R&D Mng.

Release date: 20/04/17

Rev. No: 2

Drw. No: WH.17.098

As this is the property of Warmhaus Isıtma ve Sogutma Sistemleri San. Tic. A.Ş. It must not be passed on to any person not authorized by Warmhaus Isıtma ve Sogutma Sistemleri San. Tic. A.Ş or be copied or otherwise utilized by anybody without expressed written permission.

Figure 4.3

4.5.2 Priwa 28 / Priwa 33 wiring diagrams

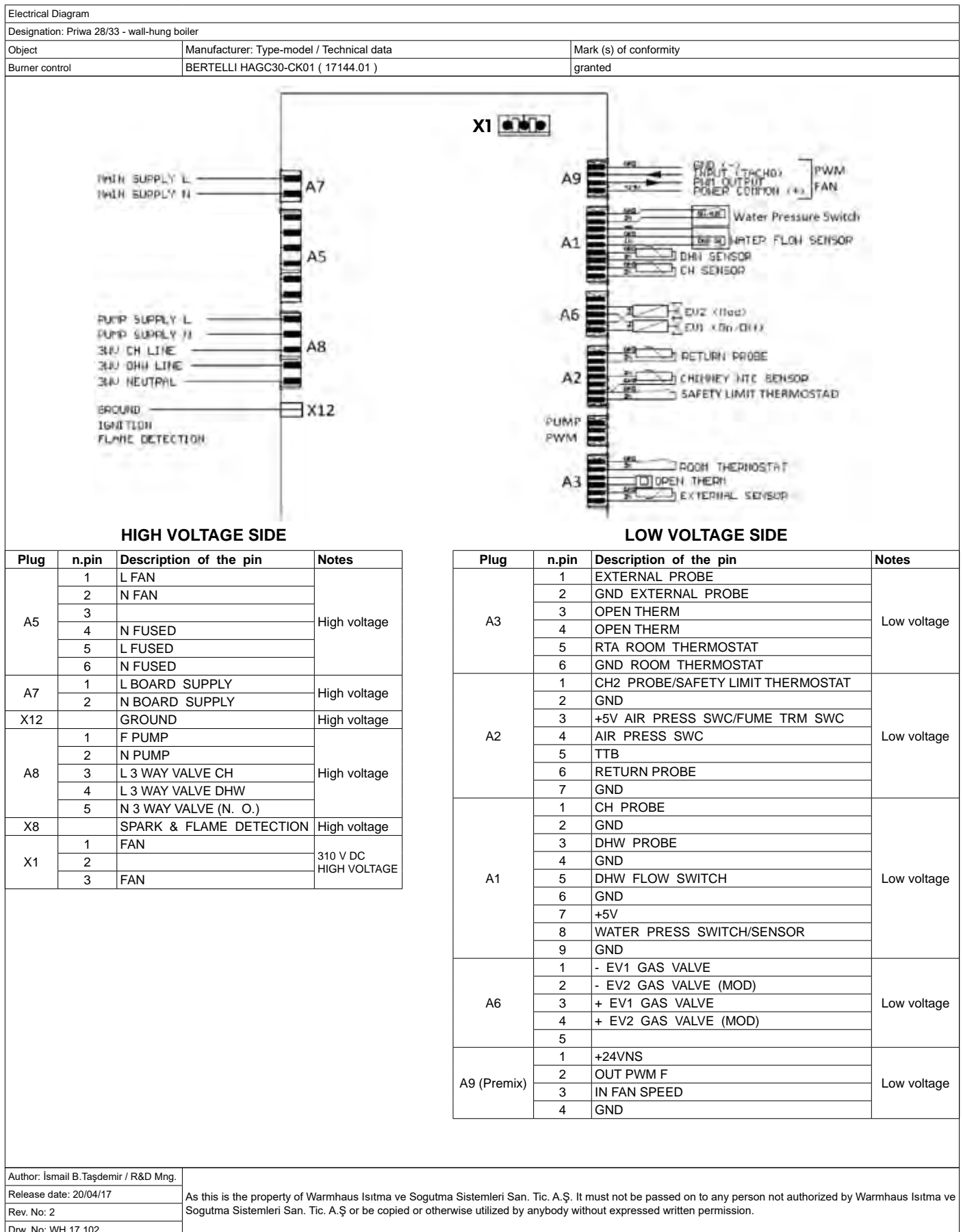

Figure 4.4

### 4.5.3 Priwa Plus 24 wiring diagrams

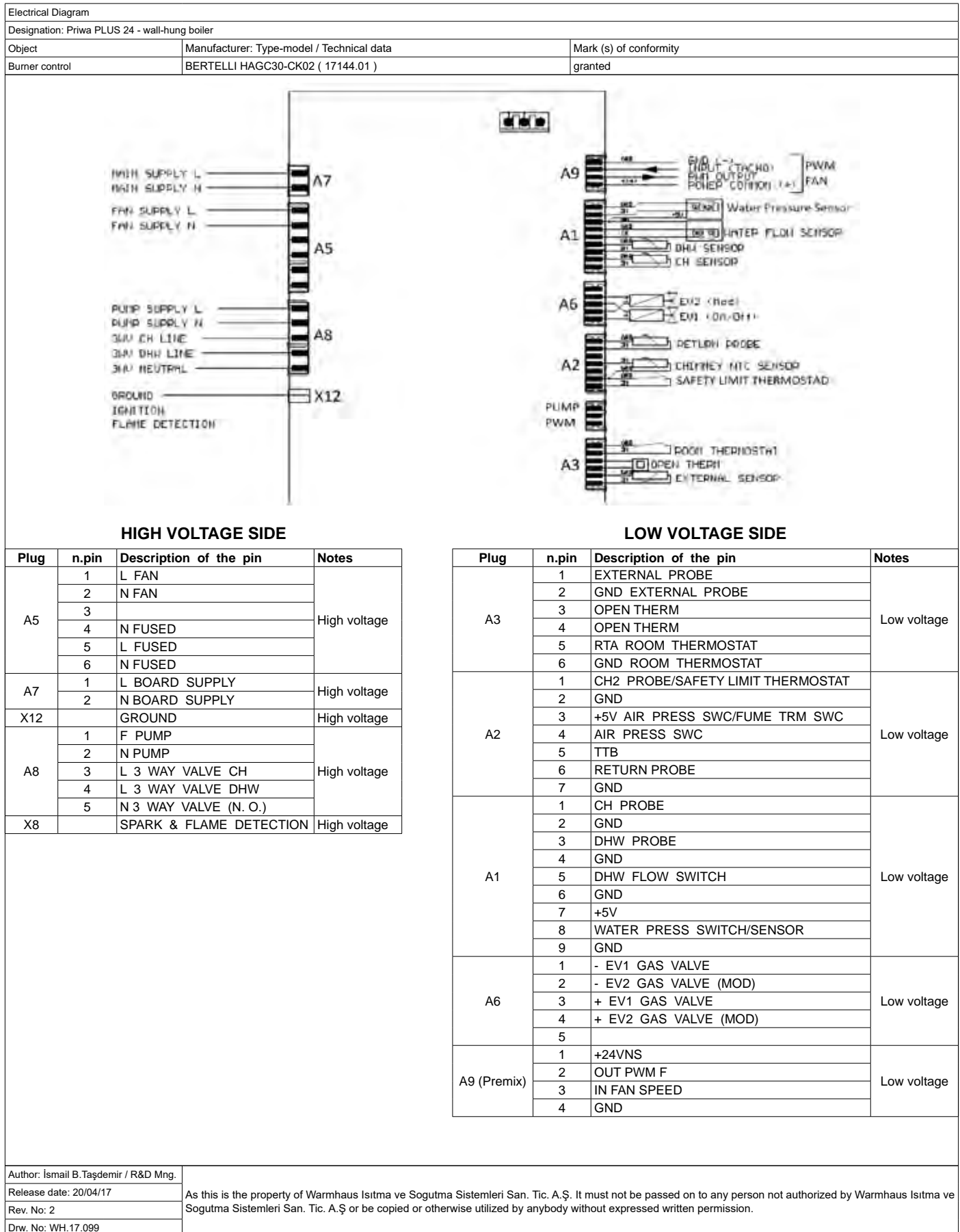

Figure 4.5

4.5.4 Priwa Plus 28 / Priwa Plus 33 wiring diagrams

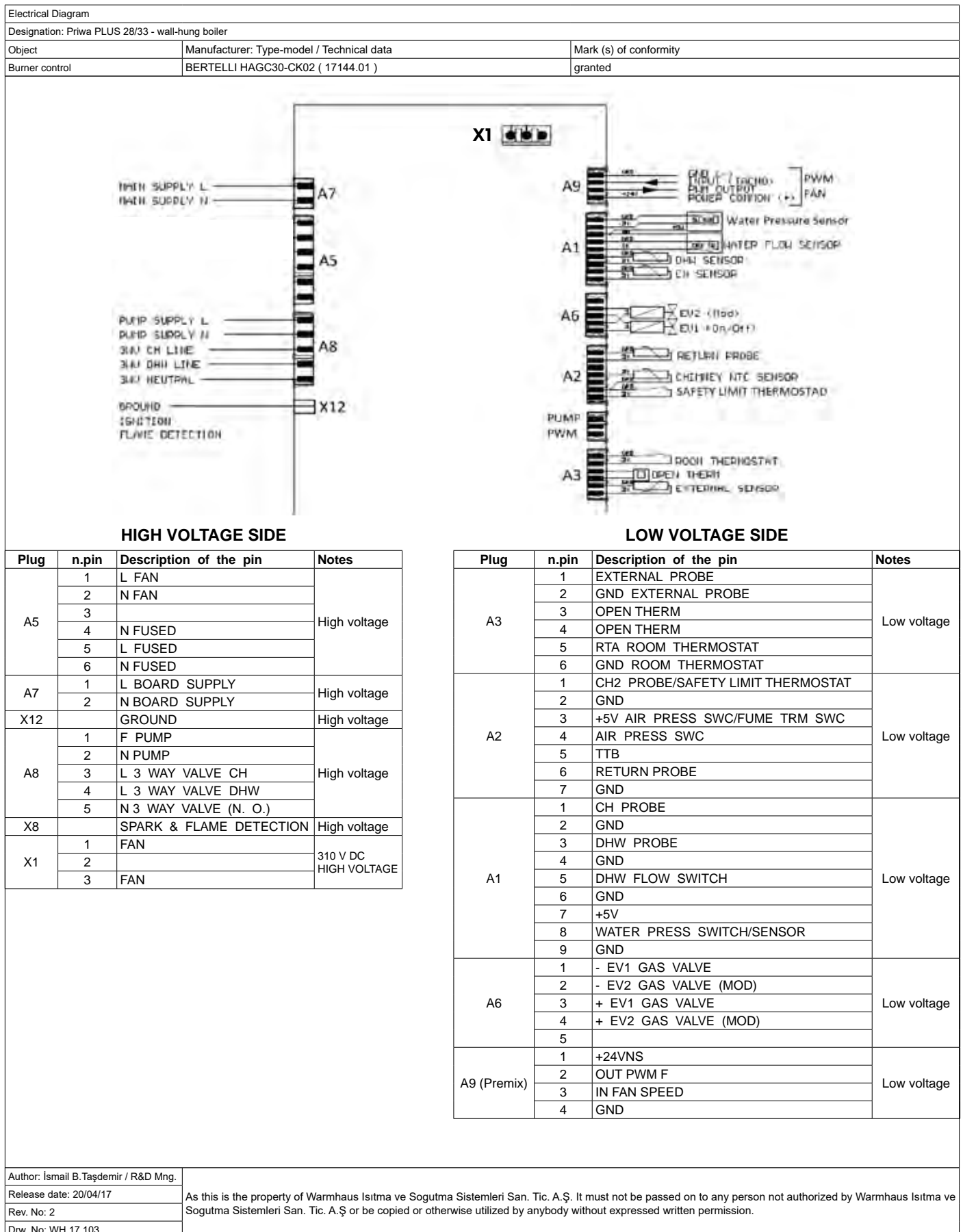

Figure 4.6

### 4.5.5 Enerwa 24 / Enerwa 2530 C

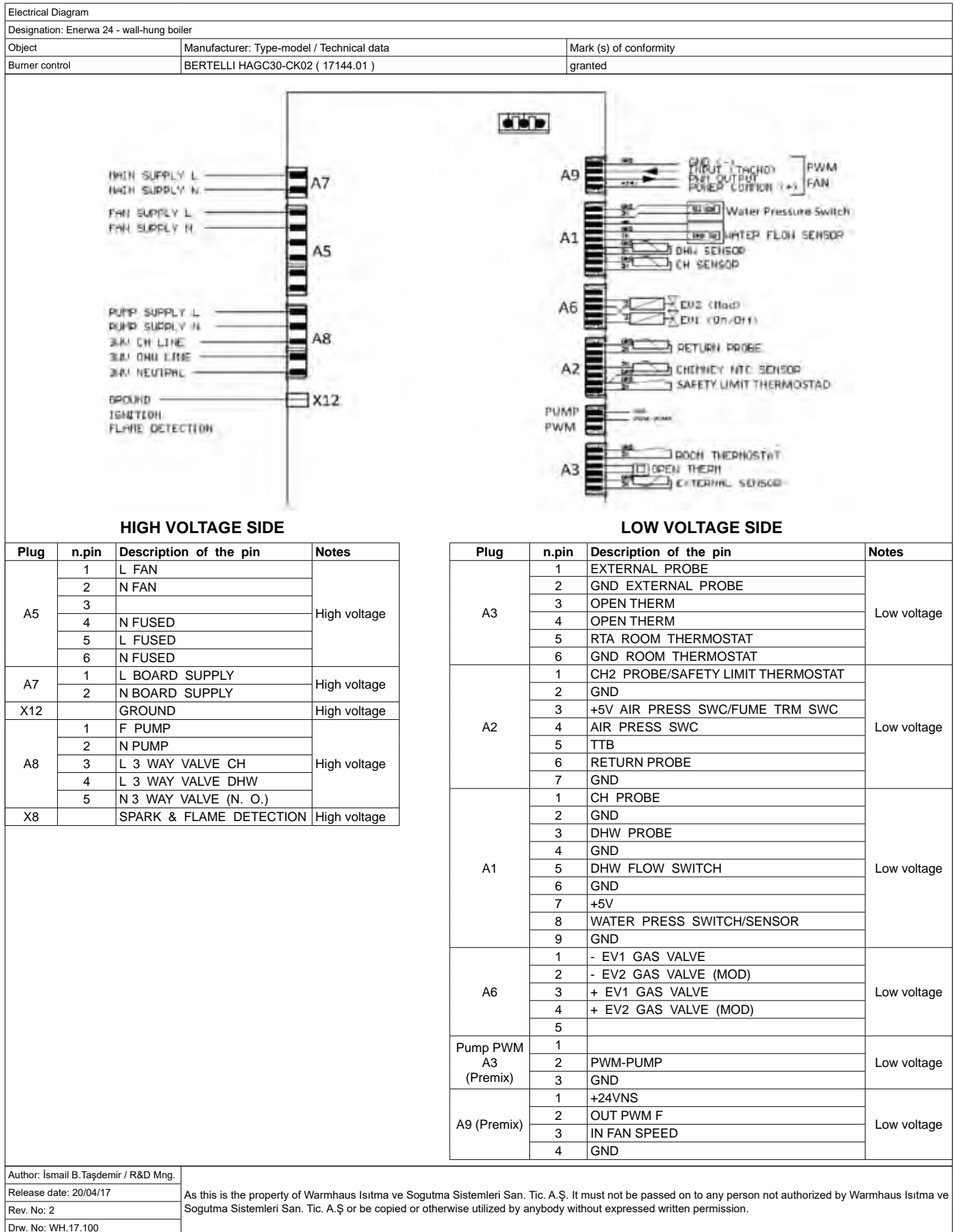

Figure 4.7

4.5.6 Enerwa 28 / Enerwa 33 / Enerwa 3035 / Enerwa 3540 C

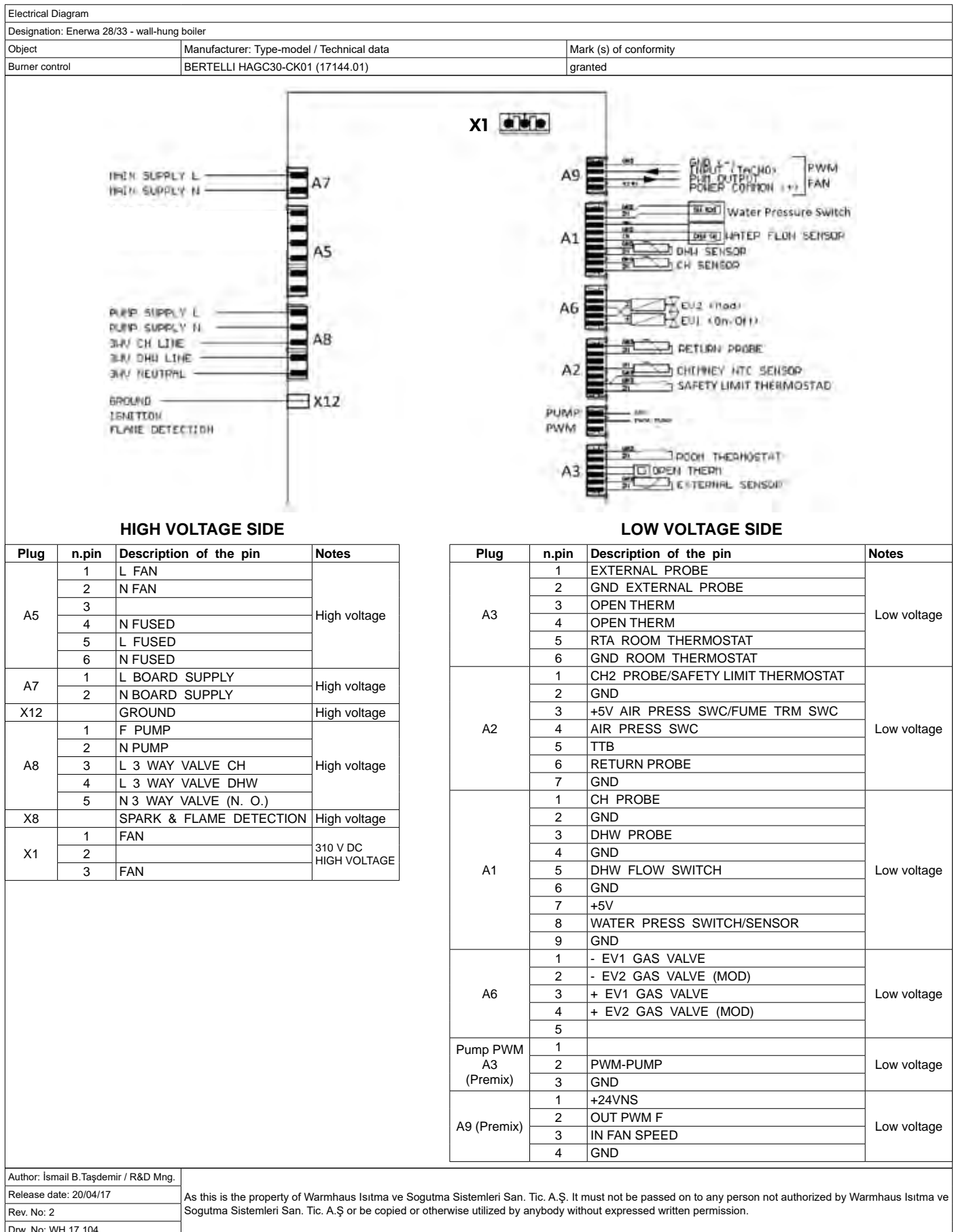
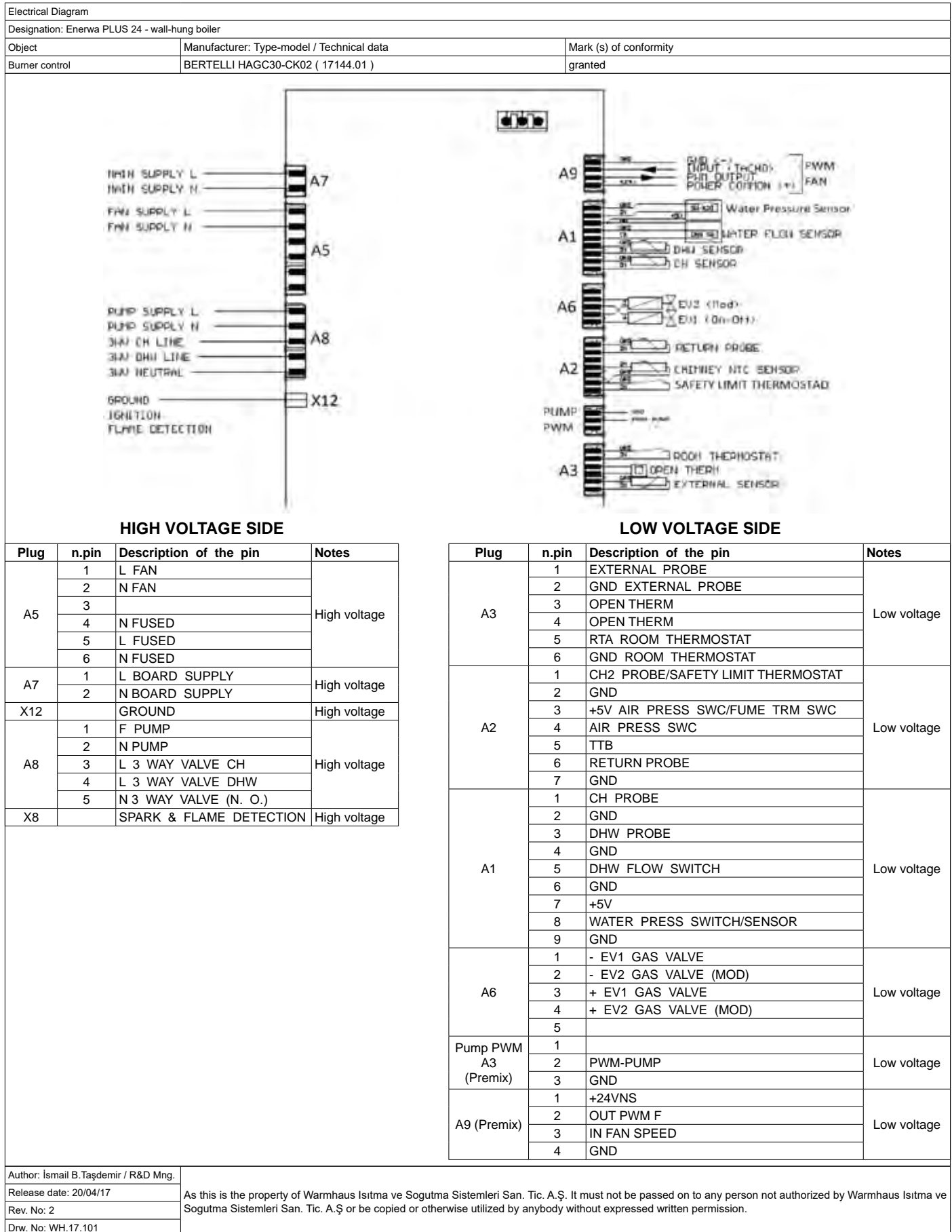

Figure 4,8

#### 4.5.7 Enerwa Plus 24 / Enerwa Plus 2530 C



Author: İsmail B. Taşdemir / R&D Mng.  
 Release date: 20/04/17  
 Rev. No: 2  
 Drw. No: WH.17.101

As this is the property of Warmhaus Isıtma ve Soğutma Sistemleri San. Tic. A.Ş. It must not be passed on to any person not authorized by Warmhaus Isıtma ve Soğutma Sistemleri San. Tic. A.Ş or be copied or otherwise utilized by anybody without expressed written permission.

Figure 4.9



4.5.8 Enerwa Plus 28 / Enerwa Plus 33 / Enerwa Plus 3035 / Enerwa Plus 3540 C

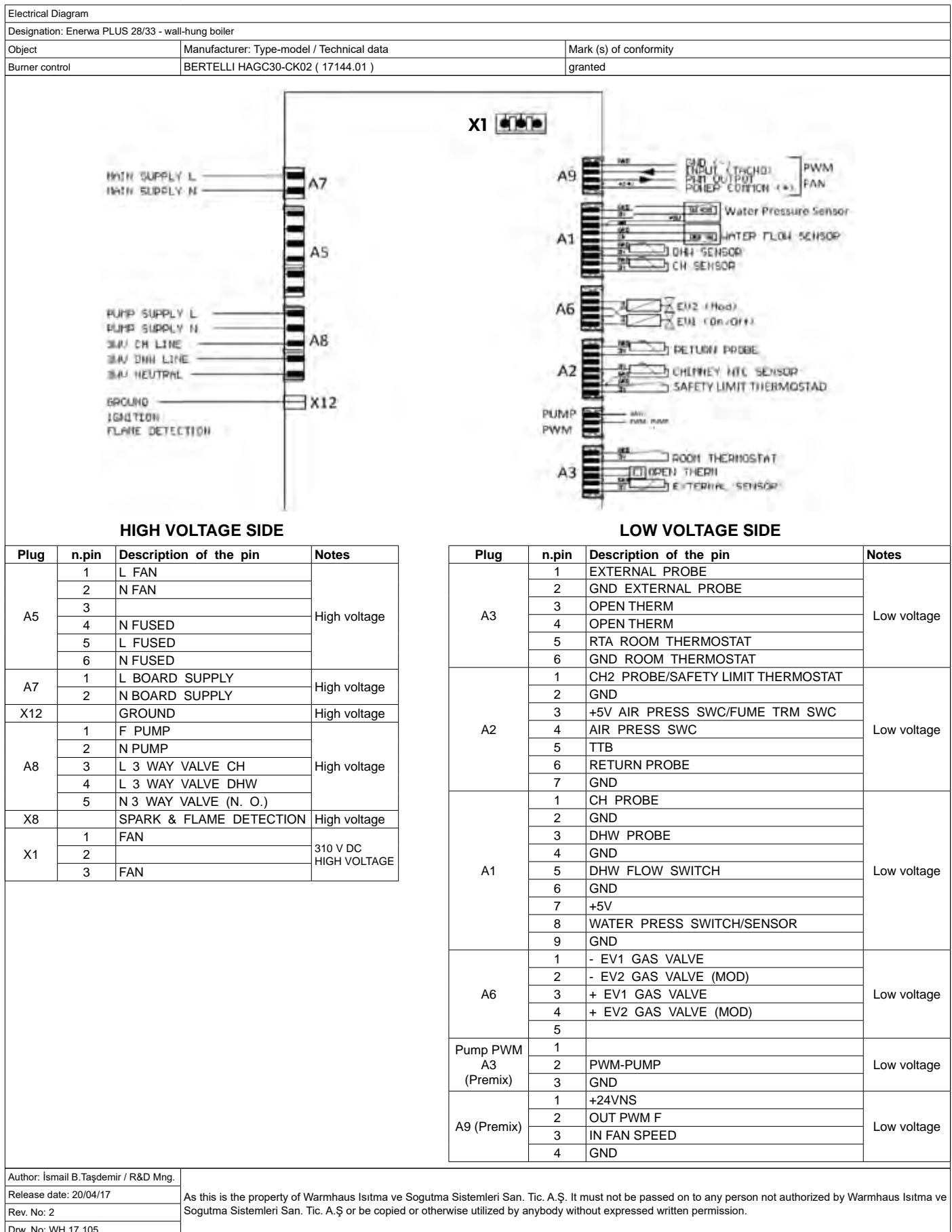

Figure 4.10

## 4.6 Silencer Assembly - Premix 24 kW Boilers

Silencer Assembly on PREMIX 24 kW boilers		
Designation: PREMIX 24 kW wall-hung boilers, ONLY		
Object	Manufacturer: Type-model / Technical data	Mark (s) of conformity
Assembly of Silencer to the 24 kW PREMIX boilers	Warmhaus PREMIX 24 kW boilers	granted

Silencer assembly for PREMIX 24 kW boilers has been described given below;  
The boilers Valid for this procedure ;

- Priwa 24
- Priwa Plus 24
- Enerwa 24 - 2530 C
- Enerwa Plus 24 - 2530 C

Introduction of silencer for 24 kW boilers aim to reduce Noise Level for following Phases;

- Air voice on max capacity comes from air suction via venturi @ Max capacity
- Reduce voice ignition phase also prevent any resonance if any.

Silencer Installation into the boiler;

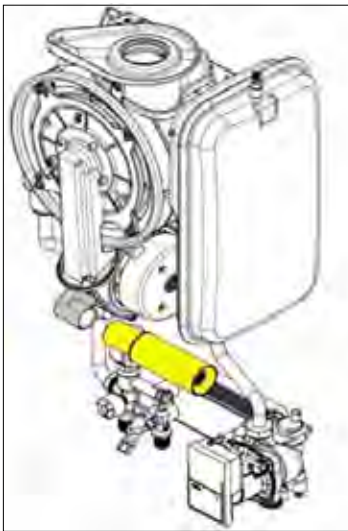

Figure 4.11

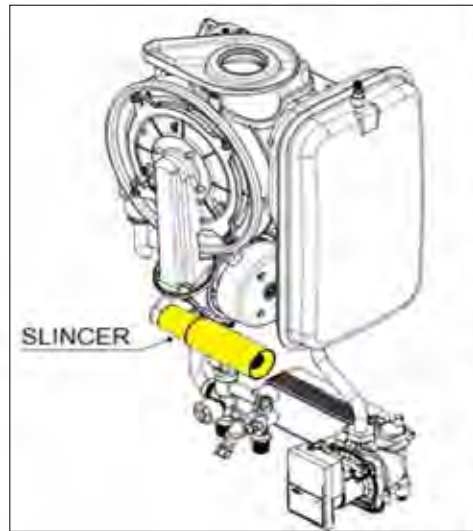

Figure 4.12

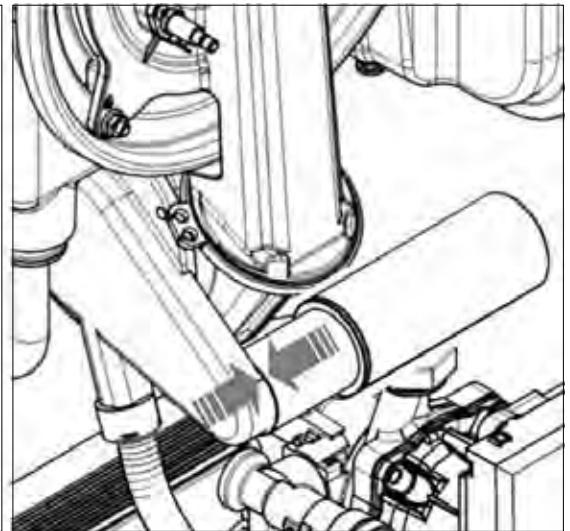

Figure 4.13

Procedure Silencer Assembly on the boiler from step 1 to 10;

- Step 1 - Open the boiler frontal casing on the boiler
- Step 2 - Assemble the Silencer to the Venturi end comply with the Fig 1 - 2
- Step 3 - Attention to the right assembly; silencer must be placed tight / placed well refer to Fig 3 arrows
- Step 4 - Close the frontal panel
- Step 5 - Set TsP Parameter P 31 = 144 for Natural Gas (G20) and LPG (G31)
- Step 6 - Set TsP Parameter P 32 = 224 for Natural Gas (G20) OR P32 = 212 for LPG (G31)
- Step 7 - Set TsP Parameter P 33 = 40 for Natural Gas (G20) and LPG (G31)
- Step 8 - Set TsP Parameter P 14 = 5 for preparation of Au-To Calibration
- Step 9 - Make calibration to the boiler according to Au-To Calibration Procedure
- Step 10 - Make no of 15 ignition attempts to let ignition adaptation algorithm works.

Author: İsmail B. Taşdemir / R&D Mng.	As this is the property of Warmhaus Isıtma ve Sogutma Sistemleri San. Tic. A.Ş. It must not be passed on to any person not authorized by Warmhaus Isıtma ve Sogutma Sistemleri San. Tic. A.Ş or be copied or otherwise utilized by anybody without expressed written permission.
Release date: 20/04/17	
Rev. No: 2	
Drw. No: WH.17.101	

## 4.7 Check Boiler Combustion & Calibration Values (Priwa 24 / Priwa Plus 24 / Enerwa 24 / Enerwa Plus 24 - 2530 C)

Check Boiler Combustion & Calibration Values		
Designation: Priwa 24 / Priwa Plus 24 / Enerwa 24 / Enerwa Plus 24		
Object	Manufacturer: Type-model / Technical data	Mark (s) of conformity
Boiler combustion set values and permitted tolerances	Warmhaus All Wal-hung boilers	granted

This document has been composed to check and adjust combustion set values and permitted tolerances for premix boilers listed above.

**Attention 1:** This procedure must be applied by authorized persons on GAS VALVE CALIBRATION function or SERVICE MAN function valid for only Premix boilers.

**Attention 2:** The combustion analyzer must be REGULARLY calibrated, If the measurement device is not calibrated, do not make any check or Gas valve Calibration.

**Attention 3:** If the measurement will be done with TESTO (flue gas analyzer brand name) that means sensor base on OXYGEN so please always use O<sub>2</sub> in this condition, do not use CO<sub>2</sub> in TESTO as it is not precise!

**Attention 4:** Make sure front cover of the boiler must be close during these measurements always!

### Procedure 1-II step Check Combustion & Calibration Values;

**Step 1** To check combustion activate the SERVICE MAN function. (please refer boiler model service man function activation document)

**Step 2** Set the boiler at MAXIMUM (HI) and MINIMUM (LO) on SERVICE MAN function and check the combustion values

**Step 3** For correct boiler operation, the content of CO<sub>2</sub> (measured with ULTRAMAT 23) or O<sub>2</sub> (TESTO devices) in the combustion fumes must observe the tolerances indicated in the following table

Combustion & Calibration Values For NATURAL GAS G20		Natural Gas - G 20 (20 mbar)				
		CO <sub>2</sub> (%)	O <sub>2</sub> (%)	CO (ppm)	NOx (ppm)	Combustion Set Point
Maximum Power= P02= HI	Nominal Value	9.0	5.1	140	26	20
	Permitted Tolerance Value	8.8 - 9.2	5.2 - 4.7	120-170	27-24	16 - 26
Ignition Power= P01	Nominal Value	9.0	4.9	55	17	35
	Permitted Tolerance Value	8.8 - 9.2	5.2 - 4.7	45-70	13-19	29 - 45
Minimum Power=P00=LO	Nominal Value	9.0	5.0	4	13	65
	Permitted Tolerance Value	8.8 - 9.2	5.2 - 4.7	0-10	12-15	44 - 97

Combustion & Calibration Values For PROPANE G31		LPG - G 31 (37 mbar)				
		CO <sub>2</sub> (%)	O <sub>2</sub> (%)	CO (ppm)	NOx (ppm)	Combustion Set Point
Maximum Power= P02= HI	Nominal Value	10.3	5.1	145	15	50
	Permitted Tolerance Value	10.5 - 10.0	5.9 - 5.0	120-170	14-25	41-65
Ignition Power= P01	Nominal Value	10.8	4.9	85	15	80
	Permitted Tolerance Value	11 - 10.5	5.5 - 4.7	70-100	10-20	66 - 97
Minimum Power=P00=LO	Nominal Value	10.1	5.5	0	13	60
	Permitted Tolerance Value	10.5 - 10	5.9 - 5.0	0-10	8-15	40 - 90

Table 4.4

\* During calibration operation boiler makes some combustion cycles. In this phase CO can be over than 1000 ppm for just short periods.

\*\* Normal operation boiler makes some combustion check cycles each 8-10 Min. In this phase CO can be over than 300 ppm for just short (5-15 sec) periods.

**WARNING: IN ANY CONDITION DURING CALIBRATION NEVER EXCEED OVER THAN > 100 FOR SET FLAME!!!!**

Author: İsmail B. Taşdemir / R&D Mng.	As this is the property of Warmhaus Isıtma ve Sogutma Sistemleri San. Tic. A.Ş. It must not be passed on to any person not authorized by Warmhaus Isıtma ve Sogutma Sistemleri San. Tic. A.Ş. or be copied or otherwise utilized by anybody without expressed written permission.
Release date: 20/04/17	
Rev. No: 2	
Drw. No: WH.17.092	

## 4.8 Check Boiler Combustion & Calibration Values (Priwa 24 n / Priwa Plus 24 n / Enerwa 24 n / Enerwa Plus 24 n - 2530 C)

Check Boiler Combustion & Calibration Values		
Designation: Priwa 24 n / Priwa Plus 24 n / Enerwa 24 n / Enerwa Plus 24 n		
Object	Manufacturer: Type-model / Technical data	Mark (s) of conformity
Boiler combustion set values and permitted tolerances	All Wall-hung boilers	granted

This document has been composed to check and adjust combustion set values and permitted tolerances for premix boilers listed above. During first start up the boiler if boiler capacity shows 24 n / 25 n this means burner is NEW GENERATION.

**Attention 1:** This procedure must be applied by authorised persons on GAS VALVE CALIBRATION function or SERVICE MAN function valid for only Premix boilers.

**Attention 2:** The combustion analyzer must be REGULARLY calibrated, If the measurement device is not calibrated, do not make any check or Gas valve Calibration.

**Attention 3:** If the measurement will be done with TESTO (flue gas analyzer brand name) that means sensor base on OXYGEN so please always use O<sub>2</sub> in this condition, Do not use CO<sub>2</sub> in TESTO is not precise!

**Attention 4:** Make sure front cover of the boiler must be close during these measurements always!

### Procedure 1-11 step Check Combustion & Calibration Values;

**Step 1** To check combustion activate the SERVICE MAN function (please refer to boiler model service man function activation document)

**Step 2** Set the boiler at MAXIMUM (HI) and MINIMUM (LO) on SERVICE MAN function and check the combustion values

**Step 3** For correct boiler operation, the content of CO<sub>2</sub> (measured

with ULTRAMAT 23) or O<sub>2</sub> (TESTO devices) in the combustion fumes must observe the tolerances indicated in the following table

**Step 4** If the value of CO<sub>2</sub> (Ultramat 23) or O<sub>2</sub> (TESTO) is different, please check FLUE GAS SIDE carefully before to proceed

**Step 5** Please check the Flue gas sealing is on position on the flue out let AND make sure no recirculation from Flue gas side to air intake AND the flue gas SET is original WARMHAUS parts or NOT

**Step 6** After Flue gas side check, Set the boiler at MAXIMUM (HI) and MINIMUM (LO) on SERVICE MAN function and check the combustion values

**Step 7** If the value of CO<sub>2</sub> (Ultramat 23) or O<sub>2</sub> (TESTO) is different, please check ELECTRODE carefully before to proceed

**Step 8** Check the electrode and their relative distances. If necessary, CALIBRATE or REPLACE the electrodes and position them correctly. (please refer to Electrode Calibration document)

**Step 9** After Flue Electrode position check, set the boiler at MAXIMUM (HI) and MINIMUM (LO) on SERVICE MAN function and check the combustion values

**Step 10** If the values measured from boiler not within tolerance, activate GAS VALVE CALIBRATION function to set the boiler on values indicated in the following table

**Step 11** After GAS VALVE CALIBRATION, set the boiler at MAXIMUM (HI) and MINIMUM (LO) on SERVICE MAN function and check the combustion values to be sure boiler well adjusted

Combustion & Calibration Values For NATURAL GAS G20		Natural Gas - G 20 (20 mbar)				
		CO <sub>2</sub> (%)	O <sub>2</sub> (%)	CO (ppm)	NOx (ppm)	Combustion Set Point
Maximum Power= P02= HI	Nominal Value	9.0	5.1	105	26	20
	Permitted Tolerance Value	8.8 - 9.2	5.2 - 4.7	90-120	27-24	16 - 26
Ignition Power= P01	Nominal Value	9.0	5.1	40	17	35
	Permitted Tolerance Value	8.8 - 9.2	5.2 - 4.7	35-50	13-19	29 - 45
Minimum Power=P00=LO	Nominal Value	9.0	5.1	3	13	55
	Permitted Tolerance Value	8.8 - 9.2	5.2 - 4.7	0-10	12-15	36 - 83

Combustion & Calibration Values For PROPANE G31		LPG - G 31 (37 mbar)				
		CO <sub>2</sub> (%)	O <sub>2</sub> (%)	CO (ppm)	NOx (ppm)	Combustion Set Point
Maximum Power= P02= HI	Nominal Value	10.4	5.3	160	15	35
	Permitted Tolerance Value	10.5 - 10.0	5.9 - 5.0	120-170	14-25	28 - 46
Ignition Power= P01	Nominal Value	10.4	5.2	65	15	60
	Permitted Tolerance Value	10.5 - 10.0	5.9 - 5.0	45-80	10-20	48 - 78
Minimum Power=P00=LO	Nominal Value	10.3	5.3	6	13	38
	Permitted Tolerance Value	10.5 - 10	5.9 - 5.0	0-10	8-15	25 - 57

Table 4.6

\* During calibration operation boiler makes some combustion cycles. In this phase CO can be over than 1000 ppm for just short periods.

\*\* Normal operation boiler makes some combustion check cycles each 8-10 Min. In this phase CO can be over than 300 ppm for just short (5-15 sec) periods.

**WARNING: IN ANY CONDITION DURING CALIBRATION NEVER EXCEED OVER THAN > 100 FOR SET FLAME!!!!**

Author: İsmail B. Taşdemir / R&D Mng.	As this is the property of Warmhaus Isıtma ve Sogutma Sistemleri San. Tic. A.Ş. It must not be passed on to any person not authorized by Warmhaus Isıtma ve Sogutma Sistemleri San. Tic. A.Ş or be copied or otherwise utilized by anybody without expressed written permission.
Release date: 01/08/2017	
Rev. No: 1	
Drw. No: WH.17.434	

## 4.9 Check Boiler Combustion & Calibration Values (Priwa 28 / Priwa Plus 28 / Enerwa 28 / Enerwa Plus 28 - 3035 C)

Check Boiler Combustion & Calibration Values		
Designation: Priwa 28 / Priwa Plus 28 / Enerwa 28 / Enerwa Plus 28		
Object	Manufacturer: Type-model / Technical data	Mark (s) of conformity
Boiler combustion set values and permitted tolerances	All Wall-hung boilers	granted

This document has been composed to check and adjust combustion set values and permitted tolerances for premix boilers listed above.

**Attention 1:** This procedure must be applied by authorized persons on GAS VALVE CALIBRATION function or SERVICE MAN function valid for only Premix boilers.

**Attention 2:** The combustion analyzer must be REGULARLY calibrated, If the measurement device is not calibrated, do not make any check or Gas valve Calibration.

**Attention 3:** If the measurement will be done with TESTO (flue gas analyzer brand name) that means sensor base on OXYGEN so please always use O<sub>2</sub> in this condition, Do not use CO<sub>2</sub> in TESTO is it is not precise!

**Attention 4:** Make sure front cover of the boiler must be close during these measurements always!

### Procedure 1-11 step Check Combustion & Calibration Values;

**Step 1** To check combustion activate the SERVICE MAN function (please refer to boiler model service man function activation document)

**Step 2** Set the boiler at MAXIMUM (HI) and MINIMUM (LO) on SERVICE MAN function and check the combustion values

**Step 3** For correct boiler operation, the content of CO<sub>2</sub> (measured with ULTRAMAT 23) or O<sub>2</sub> (TESTO devices) in the combustion fumes must observe the tolerances indicated in the following table

**Step 4** If the value of CO<sub>2</sub> (Ultramat 23) or O<sub>2</sub> (TESTO) is different, please check FLUE GAS SIDE carefully before to proceed

**Step 5** Please check the Flue gas sealing is on position on the flue out let AND make sure no recirculation from Flue gas side to air intake AND the flue gas SET is original WARMHAUS parts or NOT

**Step 6** After Flue gas side check, Set the boiler at MAXIMUM (HI) and MINIMUM (LO) on SERVICE MAN function and check the combustion values

**Step 7** If the value of CO<sub>2</sub> (Ultramat 23) or O<sub>2</sub> (TESTO) is different, please check ELECTRODE carefully before to proceed

**Step 8** Check the electrode and their relative distances. If necessary, CALIBRATE or REPLACE the electrodes and position them correctly (please refer to Electrode Calibration document)

**Step 9** After Flue Electrode position check, set the boiler at MAXIMUM (HI) and MINIMUM (LO) on SERVICE MAN function and check the combustion values

**Step 10** If the values measured from boiler not within tolerance, activate GAS VALVE CALIBRATION function to set the boiler on values indicated in the following table

**Step 11** After GAS VALVE CALIBRATION, set the boiler at MAXIMUM (HI) and MINIMUM (LO) on SERVICE MAN function and check the combustion values to be sure boiler well adjusted

Combustion & Calibration Values For NATURAL GAS G20		Natural Gas - G 20 (20 mbar)				
		CO <sub>2</sub> (%)	O <sub>2</sub> (%)	CO (ppm)	NOx (ppm)	Combustion Set Point
Maximum Power= P02= HI	Nominal Value	9.0	5.0	120	30	16
	Permitted Tolerance Value	8.8 - 9.2	5.2 - 4.7	110-150	25-35	13 - 20
Ignition Power= P01	Nominal Value	9.0	5.0	48	29	30
	Permitted Tolerance Value	8.8 - 9.2	5.2 - 4.7	35-65	23-35	25 - 39
Minimum Power=P00=LO	Nominal Value	9.0	4.9	2	16	45
	Permitted Tolerance Value	8.8 - 9.2	5.2 - 4.7	0-10	14-25	30-68

Combustion & Calibration Values For PROPANE G31		LPG - G 31 (37 mbar)				
		CO <sub>2</sub> (%)	O <sub>2</sub> (%)	CO (ppm)	NOx (ppm)	Combustion Set Point
Maximum Power= P02= HI	Nominal Value	10.5	5.0	200	15	30
	Permitted Tolerance Value	10.5 - 10.0	5.9 - 5.0	150-200	14-25	24 - 39
Ignition Power= P01	Nominal Value	10.5	5.0	60	14	55
	Permitted Tolerance Value	10.5 - 10.0	5.9 - 5.0	45 - 80	10-20	44 - 72
Minimum Power=P00=LO	Nominal Value	10.0	5.1	0	13	35
	Permitted Tolerance Value	10.5 - 10.0	5.9 - 5.0	0-10	8-15	23 -53

Table 4.5

\* During calibration operation boiler makes some combustion cycles. In this phase CO can be over than 1000 ppm for just short periods.

\*\* Normal operation boiler makes some combustion check cycles each 8-10 Min. In this phase CO can be over than 300 ppm for just short (5-15 sec) periods.

**WARNING: IN ANY CONDITION DURING CALIBRATION NEVER EXCEED OVER THAN > 100 FOR SET FLAME!!!!**

Author: İsmail B. Taşdemir / R&D Mng.	As this is the property of Warmhaus Isıtma ve Sogutma Sistemleri San. Tic. A.Ş. It must not be passed on to any person not authorized by Warmhaus Isıtma ve Sogutma Sistemleri San. Tic. A.Ş or be copied or otherwise utilized by anybody without expressed written permission.
Release date: 20/04/17	
Rev. No: 2	
Drw. No: WH.WH.17.093	

## 4.10 Check Boiler Combustion & Calibration Values (Priwa 33 / Priwa Plus 33 / Enerwa 33 / Enerwa Plus 33 - 3540 C)

Check Boiler Combustion & Calibration Values		
Designation: Priwa 33 / Priwa Plus 33 / Enerwa 33 / Enerwa Plus 33		
Object	Manufacturer: Type-model / Technical data	Mark (s) of conformity
Boiler combustion set values and permitted tolerances	All Wall-hung boilers	granted

This document has been composed to check and adjust combustion set values and permitted tolerances for premix boilers listed above.

**Attention 1:** This procedure must be applied by authorized persons on GAS VALVE CALIBRATION function or SERVICE MAN function valid for only Premix boilers.

**Attention 2:** The combustion analyzer must be REGULARLY calibrated, If the measurement device not calibrated, do not make any check or Gas valve Calibration.

**Attention 3:** If the measurement will be done with TESTO (flue gas analyzer brand name) that means sensor base on OXYGEN so please always use O<sub>2</sub> in this condition, Do not use CO<sub>2</sub> in TESTO is it is not precise!

**Attention 4:** Make sure front cover of the boiler must be close during these measurements always!

### Procedure 1-11 step Check Combustion & Calibration Values;

**Step 1** To check combustion activate the SERVICE MAN function (please refer to boiler model service man function activation document)

**Step 2** Set the boiler at MAXIMUM (HI) and MINIMUM (LO) on SERVICE MAN function and check the combustion values

**Step 3** For correct boiler operation, the content of CO<sub>2</sub> (measured with ULTRAMAT 23) or O<sub>2</sub> (TESTO devices) in the combustion fumes

must observe the tolerances indicated in the following table

**Step 4** If the value of CO<sub>2</sub> (Ultramat 23) or O<sub>2</sub> (TESTO) is different, please check FLUE GAS SIDE carefully before to proceed

**Step 5** Please check the Flue gas sealing is on position on the flue out let AND make sure no recirculation from Flue gas side to air intake AND the flue gas SET is original WARMHAUS parts or NOT

**Step 6** After Flue gas side check, Set the boiler at MAXIMUM (HI) and MINIMUM (LO) on SERVICE MAN function and check the combustion values

**Step 7** If the value of CO<sub>2</sub> (Ultramat 23) or O<sub>2</sub> (TESTO) is different, please check ELECTRODE carefully before to proceed

**Step 8** Check the electrode and their relative distances. If necessary, CALIBRATE or REPLACE the electrodes and position them correctly (please refer to Electrode Calibration document)

**Step 9** After Flue Electrode position check, set the boiler at MAXIMUM (HI) and MINIMUM (LO) on SERVICE MAN function and check the combustion values

**Step 10** If the values measured from boiler not within tolerance, activate GAS VALVE CALIBRATION function to set the boiler on values indicated in the following table

**Step 11** After GAS VALVE CALIBRATION, set the boiler at MAXIMUM (HI) and MINIMUM (LO) on SERVICE MAN function and check the combustion values to be sure boiler well adjusted

Combustion & Calibration Values For NATURAL GAS G20		Natural Gas - G 20 (20 mbar)				
		CO <sub>2</sub> (%)	O <sub>2</sub> (%)	CO (ppm)	NOx (ppm)	Combustion Set Point
Maximum Power= P02= HI	Nominal Value	9,0	5,0	140	26	15
	Permitted Tolerance Value	8,8 - 9,2	5,2 - 4,7	120 - 160	27-24	12 - 20
Ignition Power= P01	Nominal Value	9,0	5,1	47	17	30
	Permitted Tolerance Value	8,8 - 9,2	5,2 - 4,7	40 - 60	13-19	24 - 39
Minimum Power=P00=LO	Nominal Value	9,0	5,0	4	13	50
	Permitted Tolerance Value	8,8 - 9,2	5,2 - 4,7	0 - 10	12-15	33 - 75

Combustion & Calibration Values For PROPANE G31		LPG - G 31 (37 mbar)				
		CO <sub>2</sub> (%)	O <sub>2</sub> (%)	CO (ppm)	NOx (ppm)	Combustion Set Point
Maximum Power= P02= HI	Nominal Value	10,5	5,0	220,0	15,0	20
	Permitted Tolerance Value	10,5 - 10,0	5,9 - 5,0	150-230	14-25	16 -26
Ignition Power= P01	Nominal Value	10,5	5,5	80,0	14,0	40
	Permitted Tolerance Value	10,5 - 10,0	5,9 - 5,0	60 - 90	10-20	32 - 52
Minimum Power=P00=LO	Nominal Value	10,5	5,0	0,1	13,0	30
	Permitted Tolerance Value	10,5 - 10,0	5,9 - 5,0	0-10	8-15	20 - 45

Table 4.6

\* During calibration operation boiler makes some combustion cycles. In this phase CO can be over than 1000 ppm for just short periods.

\*\* Normal operation boiler makes some combustion check cycles each 8-10 Min. In this phase CO can be over than 300 ppm for just short (5-15 sec) periods.

**WARNING: IN ANY CONDITION DURING CALIBRATION NEVER EXCEED OVER THAN > 100 FOR SET FLAME!!!!**

Author: İsmail B. Taşdemir / R&D Mng.	As this is the property of Warmhaus Isıtma ve Sogutma Sistemleri San. Tic. A.Ş. It must not be passed on to any person not authorized by Warmhaus Isıtma ve Sogutma Sistemleri San. Tic. A.Ş or be copied or otherwise utilized by anybody without expressed written permission.
Release date: 20/04/17	
Rev. No: 2	
Drw. No: WH.17.094	



Serviceman Mode		
Designation: Priwa / Enerwa wall-hung boilers		
Object	Type-model / Technical data	Mark (s) of conformity
Procedure serviceman mode		Priwa 24-28-33 / Enerwa 24-28-33 granted by Warmhaus R&D
Pos No	Operation	Description GB
0		<b>Attention:</b> This procedure must be applied by authorized persons and valid for only condensing boiler. <b>Attention:</b> Serviceman time out is 30 Minute.
1		DHW knob should be at Max and CH knob should be at MIN position. <b>Attention:</b> Make sure the all radiator valves are opened and during serviceman mode if boiler can reach the maximum CH limit temperature otherwise process will interrupt. Make sure boiler frontal casing is totally closed and sealing of the boiler body is secured during serviceman mode.
2		Push two button <b>MODE + RESET</b> simultaneously
3		Wait until the approval circle complete on the LCD and release buttons.
4		When the approval circle is completed the "LO" (minimum power) will be displayed on the screen. Wait 45 seconds to be stable.
5		For "HI" mode (maximum power), turn the CH knob to max position.
6		The "HI" will be displayed on the screen. Wait 45 seconds to be stable.
7		When the serviceman mode measurements are complete, then turn the CH knob to min position.
8		Push two button <b>MODE + RESET</b> simultaneously
9		Wait until the approval circle complete on the LCD and release buttons. In this way EXIT the serviceman mode.
Author: İsmail B. Taşdemir / R&D Manager		As this is the property of Warmhaus Isıtma ve Sogutma Sistemleri San. Tic. A.Ş. It must not be passed on to any person not authorized by Warmhaus Isıtma ve Sogutma Sistemleri San. Tic. A.Ş or be copied or otherwise utilized by anybody without expressed written permission.
Release date: 20/04/2017		
Rev. No: 0		
Draw. No: WH.17.067		

Table 4.7 Procedure WH.17.067

## 4.12 Priwa Plus / Enerwa Plus Wall-Hung Boilers Serviceman Mode



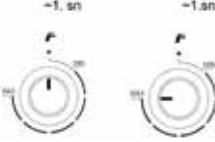
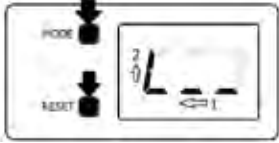
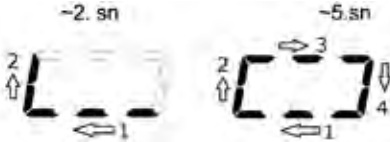
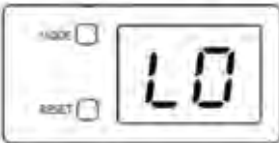
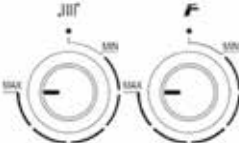
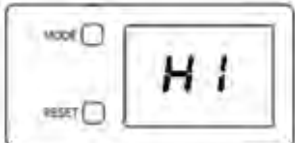

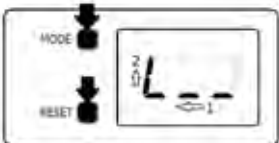
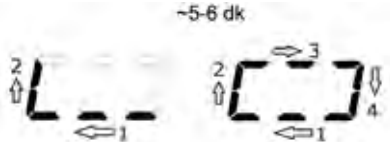





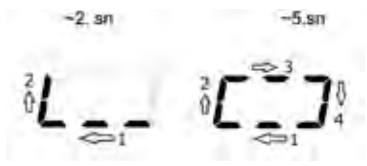

Serviceman Mode		
Designation: Priwa Plus / Enerwa Plus wall-hung boilers		
Object	Type-model / Technical data	Mark (s) of conformity
Procedure serviceman mode	Priwa Plus 24-28-33 / Enerwa Plus 24-28-33	granted by Warmhaus R&D
Pos No	Operation	Description GB
0		<b>Attention:</b> This procedure must be applied by authorized persons and valid for only condensing boiler. <b>Attention:</b> Serviceman time out is 30 Minute.
1		Press the RESET and MODE button simultaneously. <b>Attention:</b> Make sure the all radiator valves are opened and during serviceman mode if boiler can reach the maximum CH limit temperature otherwise process will interrupt. Make sure boiler frontal casing is totally closed and sealing of the boiler body is secured during serviceman mode.
2		Wait until the approval circle complete on the LCD and release buttons.
3		When the approval circle is completed the "LO" (minimum power) will be displayed on the screen. Wait 45 seconds to be stable.
4		For "HI" (maximum power) combustion menu push and hold the DHW (+) button.
5		The "HI" will be displayed on the screen. Wait 45 seconds to be stable.
6		When the serviceman mode measurements are complete, then Press the RESET and MODE button simultaneously.
7		Wait until the approval circle complete on the LCD and release buttons. In this way EXIT the serviceman mode.
Author: İsmail B. Taşdemir / R&D Manager		As this is the property of Warmhaus Isıtma ve Sogutma Sistemleri San. Tic. A.Ş. It must not be passed on to any person not authorized by Warmhaus Isıtma ve Sogutma Sistemleri San. Tic. A.Ş or be copied or otherwise utilized by anybody without expressed written permission.
Release date: 20/04/2017		
Rev. No: 0		
Drw. No: WH.17.068		

Table 4.8 Procedure WH.17068

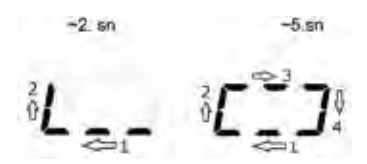

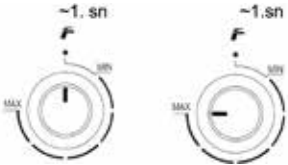
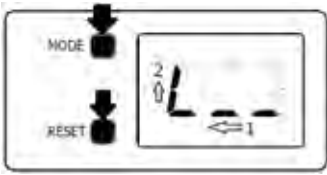
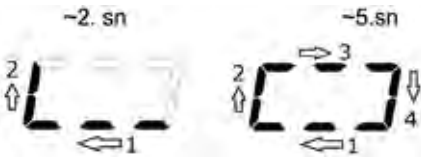
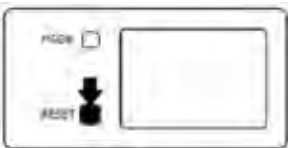
Manuel Calibration		
Designation: Priwa / Enerwa wall-hung boilers		
Object	Type-model / Technical data	Mark (s) of conformity
Procedure Manuel Calibration		Priwa 24-28-33 / Enerwa 24-28-33 granted by Warmhaus R&D
Pos No	Operation	Description GB
0		<b>Attention:</b> This procedure must be applied by authorized persons and valid for only condensing boiler. <b>Attention:</b> Calibration range is between +3 and -3. <b>Attention:</b> Set boiler to SUMMER Mode and complete Manuel Calibration within 30 minute because time out is 30 Minute.
1		Set DHW knob at Max and CH knob at MIN position. <b>Attention:</b> Make sure the all radiator valves are opened and during calibration if boiler can not reach the maximum CH limit temperature otherwise calibration process will interrupt. Make sure boiler frontal casing is totally closed and sealing of the boiler body is secured during calibration.
2		Push two button MODE + RESET simultaneously
3		Wait until the approval circle complete on the LCD and release buttons.
4		JUST AFTER RELEASE BUTTONS then Press the RESET button within 3 seconds.
5		On the screen "NA - NU" will be displayed and the boiler will try to make ignition attempts. Do not change gas pressure OR touch to the boiler on this stage!
6		Flame occurrence then boiler will try to determine the size of the flame and make a special cycle to self adaptation. Do not press any key during this time.
7		The boiler will be stable within 60 seconds after the "P0" is displayed on the screen. (P0=MINIMUM POWER)
8		When the combustion is stable press the "MODE" button. The Set Flame correction value will be displayed on the screen. <b>Attention:</b> Calibration range is between +3 and -3.

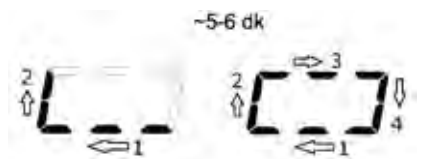
9		<p>To increase the CO<sub>2</sub> value press "MODE" button, to decrease the CO<sub>2</sub> value press "RESET" BUTTON.</p>
10		<p>After adjusting the P0 value, turn the CH knob to the position between the min and max (as seen in the picture). "P1" ignition power will be displayed on the screen. (P1=IGNITION POWER)</p>
11		<p>The boiler will be stable within 60 seconds after the "P1" is displayed on the screen. (P1=IGNITION POWER). Make the CO<sub>2</sub> correction if necessary adjustment method as described above (pos no 9). <b>Attention:</b> Calibration range is between +3 and -3.</p>
12		<p>To make the MAXIMUM POWER (P2) calibration, turn the CH knob to maximum position.</p>
13		<p>The boiler will be stable within 60 seconds after the "P2" is displayed on the screen. (P2=MAX). Make the correction adjustment as described above (pos no 9). <b>Attention:</b> Calibration range is between +3 and -3.</p>
14		<p>When the calibration is completed, turn the CH knob to min position.</p>
15		<p>Push two button MODE + RESET simultaneously</p>
16		<p>Wait until the approval circle complete on the LCD and release buttons. In this way EXIT the manual calibration menu.</p>
<p>Author: İsmail B. Taşdemir / R&amp;D Manager  Release date: 20/04/2017  Rev. No: 0  Drw. No: WH.17.063</p>		<p>As this is the property of Warmhaus Isıtma ve Soğutma Sistemleri San. Tic. A.Ş. It must not be passed on to any person not authorized by Warmhaus Isıtma ve Soğutma Sistemleri San. Tic. A.Ş or be copied or otherwise utilized by anybody without expressed written permission.</p>

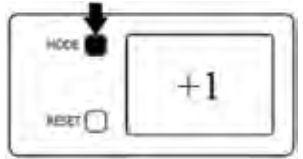
Table 4.9 Procedure WH.17.063







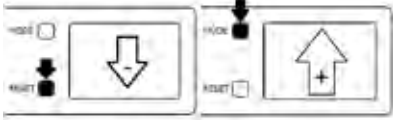
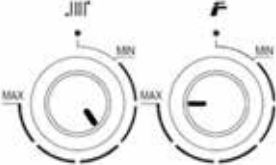
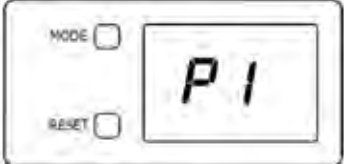
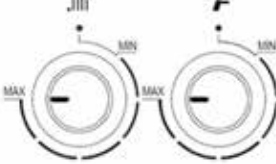
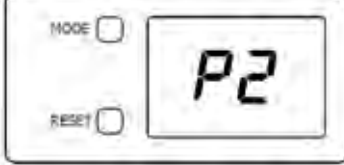
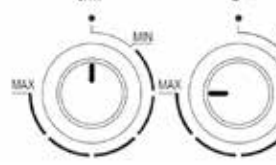
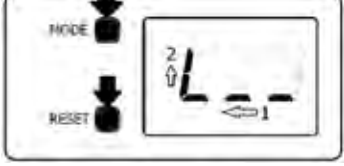
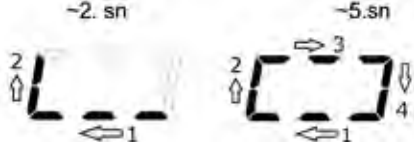





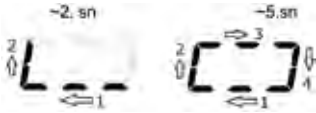

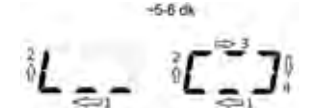
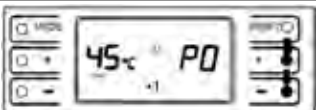
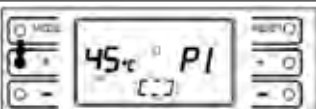
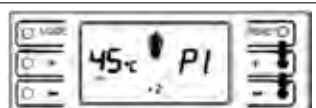
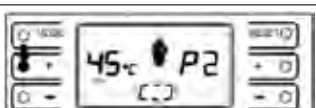
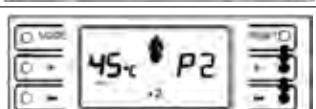

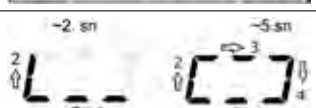



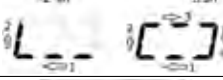

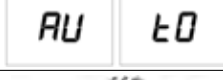
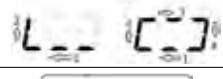
Manuel Calibration		
Designation: Priwa PLUS / Enerwa PLUS wall-hung boilers		
Object	Type-model / Technical data	Mark (s) of conformity
Procedure Manuel Calibration		granted by Warmhaus R&D
Pos No	Operation	Description GB
0		<b>Attention:</b> This procedure must be applied by authorized persons and valid for only condensing boiler. <b>Attention:</b> Calibration range is between +3 and -3. <b>Attention:</b> Set boiler to SUMMER Mode and complete Manuel Calibration within 30 minute because time out is 30 Minute.
1		Press the RESET and MODE button simultaneously. <b>Attention:</b> Make sure the all radiator valves are opened and during calibration if boiler cannot reach the maximum CH limit temperature otherwise calibration process will interrupt. Make sure boiler frontal casing is totally closed and sealing of the boiler body is secured during calibration.
2		Wait until the approval circle complete on the LCD and release buttons.
3		JUST AFTER RELEASE BUTTONS then Press the CH (-) button within 3 seconds.
4		On the screen "MA-NU" will be displayed and the boiler will try to make ignition attempts. Do not change gas pressure OR touch to the boiler on this stage!
5		Flame occurrence then boiler will try to determine the size of the flame and make a special cycle to self adaptation. Do not press any key during this time.
6		The boiler will be stable within 60 seconds after P0 AND set flame correction is displayed on the screen. (P0=MINIMUM POWER). To increase the CO <sub>2</sub> value press the DHW (+) button OR to decrease the CO <sub>2</sub> value press the DHW (-) button. Attention: Calibration range is between +3 and -3.
7		After adjusting the P0 value, keep pushing the CH (+) button until the circle complete on the screen then release to go P1 (IGNITION POWER) "P1" ignition will be displayed on the screen. Then wait 60 seconds for stabilization.
8		The boiler will be stable within 60 seconds after P1 AND set flame correction is displayed on the screen. (P1=IGNITION POWER). To increase the CO <sub>2</sub> value press the DHW (+) button OR to decrease the CO <sub>2</sub> value press the DHW (-) button. Attention: Calibration range is between +3 and -3.
9		After adjusting the P1 value, keep pushing the CH (+) button until the circle complete on the screen then release to go P2 (MAXIMUM POWER) "P2" Maximum power will be displayed on the screen. Then wait 60 seconds for stabilization.
10		The boiler will be stable within 60 seconds after P2 AND set flame correction is displayed on the screen. (P2=MAXIMUM POWER). To increase the CO <sub>2</sub> value press the DHW (+) button OR to decrease the CO <sub>2</sub> value press the DHW (-) button. Attention: Calibration range is between +3 and -3.
11		To exit the "MA-NU" calibration push and hold MODE button.
12		Wait until the approval circle complete on the LCD and release MODE button. Manual Calibration procedure has been completed.
Author: İsmail B. Taşdemir / R&D Manager		As this is the property of Warmhaus Isıtma ve Sogutma Sistemleri San. Tic. A.Ş. It must not be passed on to any person not authorized by Warmhaus Isıtma ve Sogutma Sistemleri San. Tic. A.Ş or be copied or otherwise utilized by anybody without expressed written permission.
Release date: 20/04/2017		
Rev. No: 0		
Drw. No: WH.17.064		

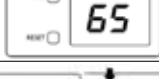
Table 4.10 Procedure WH.17064

## 4.15 Priwa / Enerwa Wall-Hung Boilers Auto Calibration

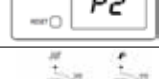
Auto Calibration			
Designation: Priwa / Enerwa wall-hung boilers			
Object	Type-model / Technical data	Mark (s) of conformity	
Procedure Au-To Calibration		Priwa 24-28-33 / Enerwa 24-28-33	granted by Warmhaus R&D
Pos No	Operation	Description GB	
0		<b>Attention:</b> This procedure must be applied by authorized persons and valid for only condensing boiler. <b>Attention:</b> The parameters as indicated DO NOT CHANGE should not be adjusted / touched by any official document supplied by Warmhaus R&D. Attention: Set boiler to SUMMER Mode and complete Au-To Calibration within 30 minute because time out is 30 Minute.	
1		<b>Attention:</b> Before auto calibration change & adjust P14=5 in the TSP menu. <b>Attention:</b> After adjusting the P14=5, in any case like lack of voltage or over run the time more than 3 minutes the P14 value will be change automatically to "0".	
2		Set DHW knob at Max and CH knob at MIN position. <b>Attention:</b> Make sure the all radiator valves are opened and during calibration if boiler cannot reach the maximum CH limit temperature otherwise calibration process will interrupt. Make sure boiler frontal casing is totally closed and sealing of the boiler body is secured during calibration.	
3		Push two button MODE + RESET simultaneously	
4		Wait until the approval circle complete on the LCD and release buttons.	
5		JUST AFTER RELEASE BUTTONS then Press the RESET button within 3 seconds.	
6		On the screen "Au-To" will be displayed and the boiler will try to make ignition attempts. Do not change gas pressure OR touch to the boiler on this stage!	
7		Flame occurrence then boiler will try to determine the size of the flame and make a special cycle to self adaptation. Do not press any key during this time.	
8		The boiler will be stable within 45 seconds after the "P0" is displayed on the screen. (P0=MINIMUM POWER)	
9		When the combustion is stable press the "MODE" button. Current set flame correction value will be displayed on the screen. This nset flame number can be differ from each appliance.	
10		To increase the CO <sub>2</sub> value press the RESET button AND to decrease the CO <sub>2</sub> value press the MODE button.	
11		After adjusting the P0 value, turn the CH knob to the position between the min and max (as seen in the picture). "P1" ignition power will be displayed on the screen. (P1=IGNITION POWER)	
12		The boiler will be stable within 45 seconds after the "P1" is displayed on the screen. (P1=IGNITION POWER). Make the CO <sub>2</sub> correction if necessary adjustment method as described above (pos no 10).	
13		To make the MAXIMUM POWER (P2) calibration, turn the CH knob to maximum position.	
14		The boiler will be stable within 45 seconds after the "P2" is displayed on the screen. (P2=MAX). Make the correction adjustment as described above (pos no 9).	
15		When the calibration is completed, turn the CH knob to min position.	
16		Push two button MODE + RESET simultaneously	
17		Wait until the approval circle complete on the LCD and release buttons. In this way EXIT the Au-To calibration menu.	
Author: İsmail B. Taşdemir / R&D Manager		As this is the property of Warmhaus Isıtma ve Soğutma Sistemleri San. Tic. A.Ş. It must not be passed on to any person not authorized by Warmhaus Isıtma ve Soğutma Sistemleri San. Tic. A.Ş or be copied or otherwise utilized by anybody without expressed written permission.	
Release date: 20/04/2017			
Rev. No: 0			
Doc No: WH.17.065			

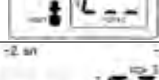



Auto Calibration		
Designation: Priwa / Enerwa wall-hung boilers		
Object	Type-model / Technical data	Mark (s) of conformity
Procedure Au-To Calibration		Priwa Plus 24-28-33 / Enerwa Plus 24-28-33 granted by Warmhaus R&D
Pos No	Operation	Description GB
0		<b>Attention:</b> This procedure must be applied by authorized persons and valid for only condensing boiler. <b>Attention:</b> The parameters as indicated DO NOT CHANGE should not be adjusted / touched by any official document supplied by Warmhaus R&D. Attention: Set boiler to SUMMER Mode and complete Au-To Calibration within 30 minute because time out is 30 Minute.
1		<b>Attention:</b> Before auto calibration change & adjust P14=5 in the TSP menu. <b>Attention:</b> After adjusting the P14=5, in any case like lack of voltage or over run the time more than 3 minutes the P14 value will be change automatically to "0".
2		Press the RESET and MODE button simultaneously. <b>Attention:</b> Make sure the all radiator valves are opened and during calibration if boiler cannot reach the maximum CH limit temperature otherwise calibration process will interrupt. Make sure boiler frontal casing is totally closed and sealing of the boiler body is secured during calibration.
3		Wait until the approval circle complete on the LCD and release buttons.
4		JUST AFTER RELEASE BUTTONS then Press the CH (-) button within 3 seconds.
5		On the screen "AU -TO" will be displayed and the boiler will try to make ignition attempts. Do not change gas pressure OR touch to the boiler on this stage!
6		Flame occurrence then boiler will try to determine the size of the flame and make a special cycle to self adaptation. Do not press any key during this time.
7		The boiler will be stable within 45 seconds after P0 AND set flame correction is displayed on the screen. (P0=MINIMUM POWER). To increase the CO <sub>2</sub> value press the DHW (-) button OR to decrease the CO <sub>2</sub> value press the DHW (+) button. <b>Attention:</b> Do not exceed calibration tolerance limits according to Combustion set document.
8		After adjusting the P0 value, keep pushing the CH (+) button until the circle complete on the screen then release to go P1 (IGNITION POWER) "P1" ignition will be displayed on the screen. Then wait 45 seconds for stabilization.
9		The boiler will be stable within 45 seconds after P1 AND set flame correction is displayed on the screen. (P1=IGNITION POWER). To increase the CO <sub>2</sub> value press the DHW (-) button OR to decrease the CO <sub>2</sub> value press the DHW (+) button. <b>Attention:</b> Do not exceed calibration tolerance limits according to Combustion set document.
10		After adjusting the P1 value, keep pushing the CH (+) button until the circle complete on the screen then release to go P2 (MAXIMUM POWER) "P2" Maximum power will be displayed on the screen. Then wait 45 seconds for stabilization.
11		The boiler will be stable within 45 seconds after P2 AND set flame correction is displayed on the screen. (P2=MAXIMUM POWER). To increase the CO <sub>2</sub> value press the DHW (-) button OR to decrease the CO <sub>2</sub> value press the DHW (+) button. <b>Attention:</b> Do not exceed calibration tolerance limits according to Combustion set document.
12		To exit the "AU-TO" calibration push and hold MODE button.
13		Wait until the approval circle complete on the LCD and release buttons.
Author: İsmail B. Taşdemir / R&D Manager		As this is the property of Warmhaus Isıtma ve Sogutma Sistemleri San. Tic. A.Ş. It must not be passed on to any person not authorized by Warmhaus Isıtma ve Sogutma Sistemleri San. Tic. A.Ş or be copied or otherwise utilized by anybody without expressed written permission.
Release date: 20/04/2017		
Rev. No: 0		
Drw. No: WH.17.066		

Table 4.12 Procedure WH.17.065

## 4.17 Priwa / Enerwa Wall-Hung Boilers Eeprom Reset



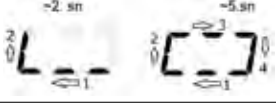
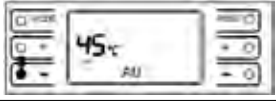
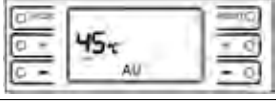
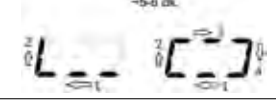
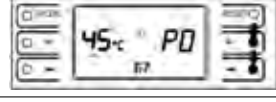
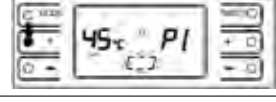
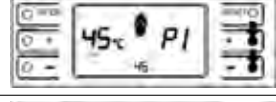
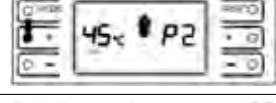
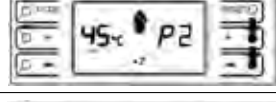

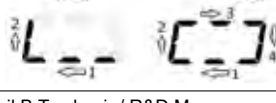





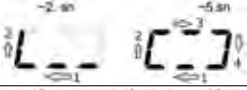
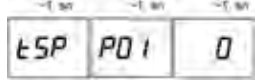

EEPROM Reset		
Designation: Priwa / Enerwa wall-hung boilers		
Object	Type-model / Technical data	Mark (s) of conformity
Procedure EEPROM Reset	Priwa 24-28-33 / Enerwa 24-28-33	granted by Warmhaus R&D
Pos No	Operation	Description GB
0		<b>Attention:</b> This procedure must be applied by authorized persons and valid for only condensing boiler. <b>Attention:</b> The parameters as indicated DO NOT CHANGE should not be adjusted / touched by any official document supplied by Warmhaus R&D. Attention: Set boiler to SUMMER Mode and complete Au-To Calibration within 30 minute because time out is 30 Minute.
1		<b>Attention:</b> Before auto calibration change & adjust P14=5 in the TSP menu. <b>Attention:</b> After adjusting the P14=5, in any case like lack of voltage or over run the time more then 3 minutes the P14 value will be change automatically to "0".
2		Set DHW knob at Max and CH knob at MIN position. Attention: Make sure the all radiator valves are opened and during calibration if boiler can not reach the maximum CH limit temperature otherwise calibration process will interrupt. Make sure boiler frontal casing is totally closed and sealing of the boiler body is secured during calibration.
3		Push two button MODE + RESET simultaneously
4		Wait until the approval circle complete on the LCD and release buttons.
5		JUST AFTER RELEASE BUTTONS then Press the RESET button within 3 seconds.
6		On the screen "Au -To" will be displayed and the boiler will try to make ignition attempts. Do not change gas pressure OR touch to the boiler on this stage!
7		Flame occurrence then boiler will try to determine the size of the flame and make a special cycle to self adaptation. Do not press any key during this time.
8		The boiler will be stable within 45 seconds after the "P0" is displayed on the screen. (P0=MINIMUM POWER)
9		When the combustion is stable press the "MODE" button. Current set flame correction value will be displayed on the screen. This nset flame number can be differ from each appliance.
10		To increase the CO <sub>2</sub> value press the RESET button AND to decrease the CO <sub>2</sub> value press the MODE button.
11		After adjusting the P0 value, turn the CH knob to the position between the min and max (as seen in the picture). "P1" ignition power will be displayed on the screen. (P1=IGNITION POWER)
12		The boiler will be stable within 45 seconds after the "P1" is displayed on the screen. (P1=IGNITION POWER). Make the CO <sub>2</sub> correction if necessary adjustment method as described above (pos no 10).
13		To make the MAXIMUM POWER (P2) calibration, turn the CH knob to maximum position.
14		The boiler will be stable within 45 seconds after the "P2" is displayed on the screen. (P2=MAX). Make the correction adjustment as described above (pos no 9).
15		When the calibration is completed, turn the CH knob to min position.
16		Push two button MODE + RESET simultaneously
17		Wait until the approval circle complete on the LCD and release buttons. In this way EXIT the Au-To calibration menu.
Author: İsmail B. Taşdemir / R&D Manager		As this is the property of Warmhaus Isıtma ve Sogutma Sistemleri San. Tic. A.Ş. It must not be passed on to any person not authorized by Warmhaus Isıtma ve Sogutma Sistemleri San. Tic. A.Ş or be copied or otherwise utilized by anybody without expressed written permission.
Release date: 20/04/2017		
Rev. No: 0		
Drw. No: WH.17.069		

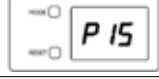
Table 4.13 Procedure WH.17.069

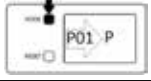
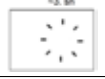





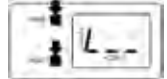
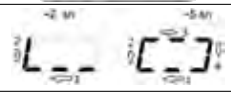





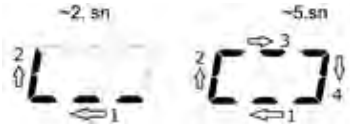



EEPROM Reset			
Designation: Priwa Plus / Enerwa Plus wall-hung boilers			
Object	Type-model / Technical data	Mark (s) of conformity	
Procedure EEPROM Reset		Priwa Plus 24-28-33 / Enerwa Plus 24-28-33	granted by Warmhaus R&D
Pos No	Operation	Description GB	
0		<p><b>Attention:</b> This procedure must be applied by authorized persons and valid for only condensing boiler.</p> <p><b>Attention:</b> The parameters as indicated DO NOT CHANGE should not be adjusted / touched by any official document supplied by Warmhaus R&amp;D.</p>	
1		Press the RESET and CH (-) button simultaneously.	
2		Wait until the approval circle complete on the LCD and release buttons	
3		<p>The screen will appear tSP - Parameter = 01 - Value = 0</p> <p><b>Attention:</b> Do not change this parameter</p>	
4		From this moment toggle CH (+) and CH (-) to increase to decrease any parameter aimed to be changed P15.	
5		Once you reach the TS 15 parameter Toggle DHW (+) to increase to SET PARAMETER VALUE +1 more than default parameter. (For instance if default parameter P15=1 then make it P15=2)	
6		<p>Push the RESET button to save the value.</p> <p>Wait until the approval circle complete on the LCD and release button.</p> <p>Wait at least 1 minutes. The EPROM will be reseted.</p>	
7		Wait at least 60 seconds; the eeprom will be reset automatically.	
8		Change the P15 value and reduce the value -1 to its previous value. (For instance if default parameter was P15=1 then increased to P15=2 after wait of 60 sec, turn back to previous value P15=1) If you do not remember what the previous value was then check the type plate on the boiler power then find the Parameter 15 on the TsP parameter P15 on the list and find the default value.	
9		<p>Push the RESET button to save the value.</p> <p>Wait until the approval circle complete on the LCD and release button.</p>	
10		Push two button CH (-) and RESET simultaneously to exit the TSP menu.	
11		Wait until the approval circle complete on the LCD and release buttons. In this way EXIT the TsP Menu.	
Author: İsmail B. Taşdemir / R&D Manager		As this is the property of Warmhaus Isıtma ve Sogutma Sistemleri San. Tic. A.Ş. It must not be passed on to any person not authorized by Warmhaus Isıtma ve Sogutma Sistemleri San. Tic. A.Ş or be copied or otherwise utilized by anybody without expressed written permission.	
Release date: 20/04/2017			
Rev. No: 0			
Drw. No: WH.17.070			

Table 4.14 Procedure WH.17.070

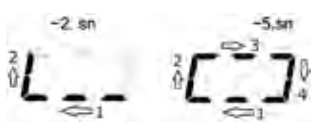
## 4.19 Lawa / Priwa / Enerwa Wall-Hung Boilers Info Menü

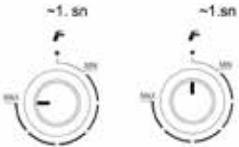
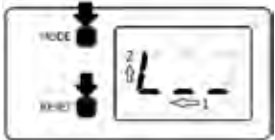
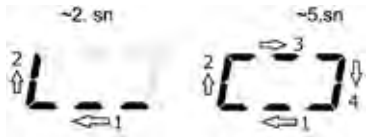
Info Menu			
Designation: Lawa / Priwa / Enerwa wall-hung boilers			
Object	Type-model / Technical data		Mark (s) of conformity
Procedure Info Menu		Lawa 24-28 / Priwa 24-28-33 / Enerwa 24-28-33	granted by Warmhaus R&D
Pos No	Operation	Description GB	
0		<b>Attention:</b> This procedure must be applied by authorized persons.	
1		Set DHW knob at Min and CH knob at MAX position.	
2		Push two button MODE + RESET simultaneously	
3		Wait until the approval circle complete on the LCD and release buttons.	
4		Now you are in the "Info" menu. Toggle the values by pressing "MODE" OR "RESET" buttons. You can not change the values displayed in the "info" menu. From this moment by toggle MODE you can check following <b>Information:</b> Last 10 Failure (Error) codes - Information by reading some real values – Counters Menu	
5		From AL 0 to AL9 show last 10 Error code that boiler had previously. Error code shown after the AL code (i.e.). When you see AL0 on the screen wait 1-2 sec the error code will shown like E06	
6		<p>INFO MENU = In X value shows following information</p> <p>In0 = SW version</p> <p>In1 = Display of external probe temperature, if connected, °C</p> <p>In2 = Display of CH Flow probe temperature, °C</p> <p>In3 = Display of Safety Limit probe temperature (Lawa) – Display flue probe temperature (Priwa &amp; Enerwa), °C</p> <p>In4 = Display of DHW probe temperature, °C</p> <p>In5 = Display of CH Return probe temperature, °C</p> <p>In6 = Display of real heating temperature SET, °C</p> <p>In7 = Display of actual power level, %</p> <p>In8 = Display of Flow-meter actual value, Lt / per-minute</p> <p>In9 = Display of water pressure value (on PLUS models ONLY), Bars</p> <p>In10 = Actual Fan Speed (Priwa &amp; Enerwa), RPMx100</p>	











7		<p>COUNTER MENU = Co X value shows following information          Co0 = Display of main supply hours, hx100          Co1 = Display of burner total functioning hours, hx100          Co2 = Display of burner total ignitions, x1000          Co3 = Display of total failures shown on the boiler, x1          Co4 = Display of number of TSP menu activation, x1          Co5 = Display of number of OEM menu activation, x1          Co6 = -</p>
8		<p>Inside AL menu it is possible to clear history buffer pushing RESET and Wait until the approval circle complete on the LCD and release button. In this way Alarm history will be erased.</p>
9		<p>To Exit the menu set DHW knob at MIN and CH knob at MAX position.</p>
10		<p>Push two button MODE + RESET simultaneously</p>
11		<p>Wait until the approval circle complete on the LCD and release buttons. In this way EXIT the info menu.</p>
Author: İsmail B. Taşdemir / R&D Manager		<p>As this is the property of Warmhaus Isıtma ve Soğutma Sistemleri San. Tic. A.Ş. It must not be passed on to any person not authorized by Warmhaus Isıtma ve Soğutma Sistemleri San. Tic. A.Ş or be copied or otherwise utilized by anybody without expressed written permission.</p>
Release date: 20/04/2017		
Rev. No: 0		
Drw. No: WH.17.071		

Table 4.15 Procedure WH.17.071

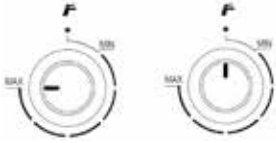
## 4.20 Lawa / Priwa / Enerwa Wall-Hung Boilers Info Menu

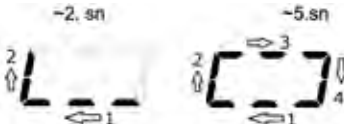
Info Menu		
Designation: Lawa / Priwa / Enerwa wall-hung boilers		
Object		Type-model / Technical data
Procedure Info Menu		Lawa Plus 24-28 / Priwa Plus 24-28-33 / Enerwa Plus 24-28-33
		Mark (s) of conformity
		granted by Warmhaus R&D
Pos No	Operation	Description GB
0		<b>Attention:</b> This procedure must be applied by authorized persons.
1		Press the RESET and CH (+) button simultaneously.
2		Wait until the approval circle complete on the LCD and release buttons.
3		Now you are in the "Info" menu. Toggle the values by pressing DHW ( + ) OR DHW ( - ) buttons. You can not change the values displayed in the "info" menu. From this moment by toggle DHW ( + ) you can check following <b>Informations:</b> Last 10 Failure ( Error ) codes - Information by reading some real values – Counters Menu
4		From AL 0 to AL9 show last 10 Error code that boiler had previously. Error code shown after the AL code (ie. When you see AL0 on the screen wait 1-2 sec the error code will show like E06.)
5		<p>INFO MENU = In X value shows following information</p> <ul style="list-style-type: none"> <li>In0 = SW version</li> <li>In1 = Display of external probe temperature, if connected, °C</li> <li>In2 = Display of CH Flow probe temperature, °C</li> <li>In3 = Display of Safety Limit probe temperature (Lawa) – Display flue probe temperature (Priwa &amp; Enerwa), °C</li> <li>In4 = Display of DHW probe temperature, °C</li> <li>In5 = Display of CH Return probe temperature, °C</li> <li>In6 = Display of real heating temperature SET, °C</li> <li>In7 = Display of actual power level, %</li> <li>In8 = Display of Flow-meter actual value, Lt / per-minute</li> <li>In9 = Display of water pressure value (on PLUS models ONLY), Bars</li> <li>In10 = Actual Fan Speed (Priwa &amp; Enerwa), RPMx100</li> </ul>

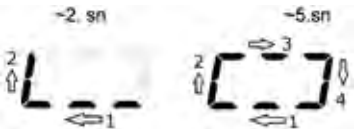
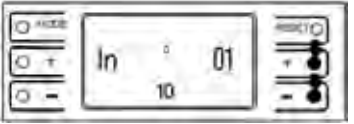
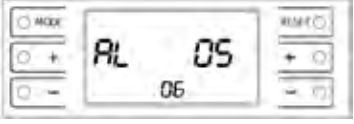
6		<p>COUNTER MENU = Co X value shows following information  Co0 = Display of main supply hours, hx100  Co1 = Display of burner total functioning hours, hx100  Co2 = Display of burner total ignitions, x1000  Co3 = Display of total failures shown on the boiler, x1  Co4 = Display of number of TSP menu activation, x1  Co5 = Display of number of OEM menu activation, x1  Co6 = -</p>
7		<p>Inside AL menu it is possible to clear history buffer pushing RESET and Wait until the approval circle complete on the LCD and release button. In this way Alarm history will be erased.</p>
8		<p>To exit the info menu, push the CH ( + ) and RESET button simultaneously.</p>
9		<p>Wait until the approval circle complete on the LCD and release buttons.</p>
<p>Author: İsmail B. Taşdemir / R&amp;D Manager</p>		<p>As this is the property of Warmhaus Isıtma ve Soğutma Sistemleri San. Tic. A.Ş. It must not be passed on to any person not authorized by Warmhaus Isıtma ve Soğutma Sistemleri San. Tic. A.Ş or be copied or otherwise utilized by anybody without expressed written permission.</p>
<p>Release date: 20/04/2017</p>		
<p>Rev. No: 0</p>		
<p>Drw. No: WH.17.072</p>		

Table 4.16 Procedure WH.17.072

## 4.21 Lawa / Priwa / Enerwa Wall-Hung Boilers Deaeration Mode



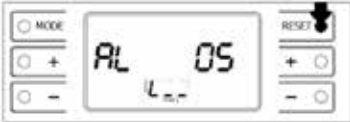
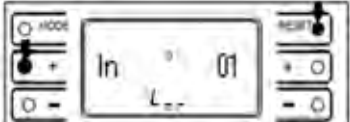
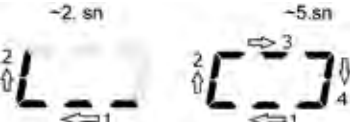

Deaeration MODE			
Designation: Procedure Deaeration Function			
Object	Type-model / Technical data		Mark (s) of conformity
Procedure Deaeration Function		Lawa 24-28 / Priwa 24-28-33 / Enerwa 24-28-33	granted by Warmhaus R&D
Pos No	Operation	Description GB	
0		<p><b>Attention:</b> This procedure must be applied by authorized persons.</p> <p><b>Attention:</b> During this function make sure the boiler water pressure is OK and automatic air vent cap is open. During operation if water pressure reduces then fill full the water to the installation by using filling tap or loop.</p>	
1		First of all press the MODE button to select switch "OFF" the boiler. MODE order is WINTER - SUMMER - OFF circle	
2		Wait until the approval circle complete on the LCD and release buttons.	
3		Be sure that the "OFF" is displayed on the screen. If not press again the "MODE" and repeat the step above Until OFF symbol shown on the screen.	
4		The boiler should be OFF.	
5		Set both knobs at MAX position	
6		Push and hold the RESET button.	
7		Wait until the approval circle complete on the LCD and release buttons.	
8		The "Air" will be displayed on the screen. Boiler will start the Deaeration function. During this function pump and 3-way valve are activated/deactivated in order to have deaeration of the hydraulic plant. This function ends pushing again RESET for circle time OR at the end of deaeration time 12 minutes.	
9		To exit the "Air" function, push and hold the RESET button. OR wait 12 minutes for time out.	
10		Wait until the approval circle complete on the LCD and release buttons.	
Author: İsmail B. Taşdemir / R&D Manager		As this is the property of Warmhaus Isıtma ve Soğutma Sistemleri San. Tic. A.Ş. It must not be passed on to any person not authorized by Warmhaus Isıtma ve Soğutma Sistemleri San. Tic. A.Ş or be copied or otherwise utilized by anybody without expressed written permission.	
Release date: 20/04/2017			
Rev. No: 0			
Drw. No: WH.17.073			

Table 4.17 Procedure WH.17.073





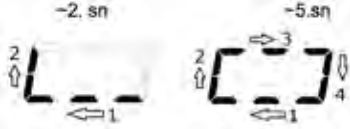
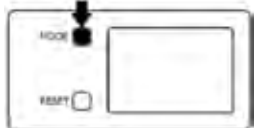

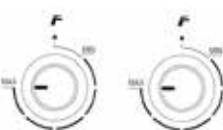
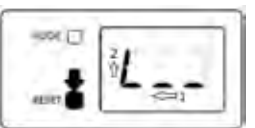
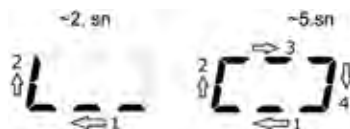
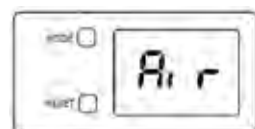
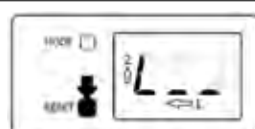
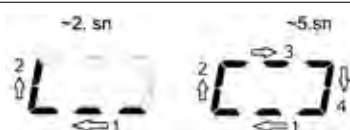
Deaeration MODE		
Designation: Lawa Plus / Priwa Plus / Enerwa Plus wall-hung boilers		
Object	Type-model / Technical data	Mark (s) of conformity
Procedure Deaeration Function		granted by Warmhaus R&D
Pos No	Operation	Description GB
0		<b>Attention:</b> This procedure must be applied by authorized persons. <b>Attention:</b> During this function make sure the boiler water pressure is OK and automatic air vent cap is open. During operation if water pressure reduces then fill full the water to the installation by using filling tap or loop.
1		First of all press the MODE button to select switch "OFF" the boiler. MODE order is WINTER - SUMMER - OFF circle
2		Wait until the approval circle complete on the LCD and release buttons.
3		Be sure that the "OFF" is displayed on the screen. If not press again the "MODE" and repeat the step above Until OFF symbol shown on the screen.
4		The boiler should be OFF.
5		Push the RESET and DHW (-) button simultaneously.
6		Wait until the approval circle complete on the LCD and release buttons.
7		The "Air" will be displayed on the screen. Boiler will start the Deaeration function. During this function pump and 3-way valve are activated/deactivated in order to have deaeration of the hydraulic plant. This function ends pushing again RESET for circle time OR at the end of deaeration time 12 minutes. (counter show on the screen 72 x 10 sn = 12 min)
8		To exit the "Air" function, push and hold the RESET and DHW (-) button simultaneously OR wait 12 minutes for time out.
9		Wait until the approval circle complete on the LCD and release buttons.
Author: İsmail B. Taşdemir / R&D Manager		Wait until the approval circle complete on the LCD and release buttons.
Release date: 20/04/2017		
Rev. No: 0		
Drw. No: WH.17.074		

Table 4.18 Procedure WH.17.074

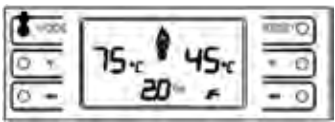
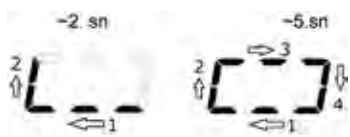
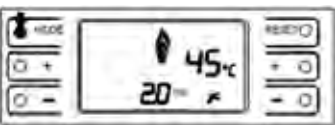
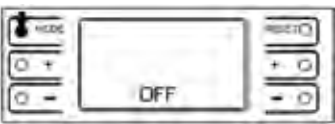
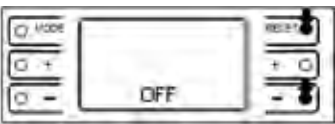
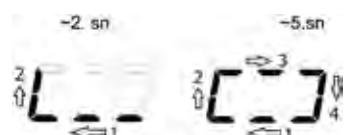
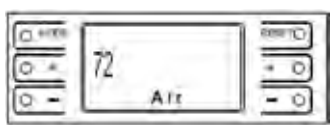
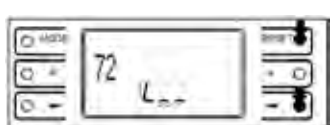
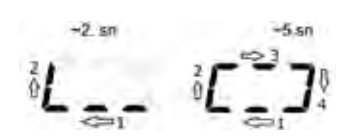
## 4.23 Lawa / Priwa / Enerwa Wall-Hung Boilers DHW Preheat Mode

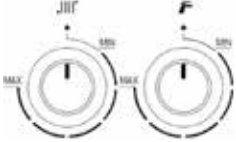
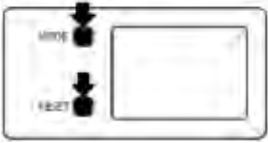
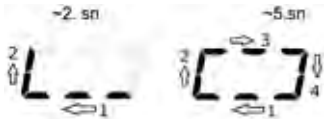
DHW Preheat Mode		
Designation: Lawa / Priwa / Enerwa wall-hung boilers		
Object	Type-model / Technical data	Mark (s) of conformity
Procedure DHW Preheat Mode		Lawa 24-28 / Priwa 24-28-33 / Enerwa 24-28-33
granted by Warmhaus R&D		
Pos No	Operation	Description GB
0		<b>Attention:</b> This procedure must be applied by authorized persons.
1		Set both knobs at MIN position
2		Push two button MODE + RESET simultaneously
3		Wait until the approval circle complete on the LCD and release buttons
4		The screen will appear tSP - P01 - 0 <b>Attention:</b> Do not change this parameter
5		From this moment toggle MODE ( + ) to increase or RESET ( - ) to decrease any parameter aimed to be changed. Find the parameter P18
6		Ones you reach the parameter P18 to change the value, on the screen turn the DHW knob to MAX position. Set the P18 = 0. This is preparation for Preheat function.
7		Move DHW knob at MIN position and then after MAX position (SWING)
8		The value you set on the screen will flashing after this SWING. Ones the flashing stop the value is SAVED.
9		From this moment toggle MODE ( + ) to increase and find the parameter P27
10		Ones you reach the parameter P27 to change the value, on the screen turn the DHW knob to MAX position. Set the P27 = 52 (if DHW inlet temperature is colder than 12 °C then you can set the P27 = 55). This is preparation for Preheat function.

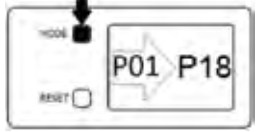

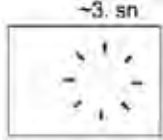
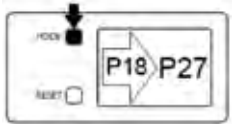
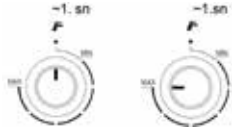
11		Move DHW knob at MIN position and then after MAX position (SWING) to save parameter value.
12		The value you set on the screen will flashing after this SWING. Ones the flashing stop the value is SAVED.
13		From this moment toggle MODE ( + ) to increase and find the parameter P42
14		Ones you reach the parameter P42 to change the value, on the screen turn the DHW knob to MAX position. Set the P42 = 1, this will allow the preheat Enabled
15		Move DHW knob at MIN position and then after MAX position (SWING) to save parameter value.
16		The value you set on the screen will flashing after this SWING. Ones the flashing stop the value is SAVED.
17		To Exit the Adjustment set both knobs at MIN position
18		Push two button MODE + RESET simultaneously
19		Wait until the approval circle complete on the LCD and release buttons
Author: İsmail B. Taşdemir / R&D Manager		As this is the property of Warmhaus Isıtma ve Soğutma Sistemleri San. Tic. A.Ş. It must not be passed on to any person not authorized by Warmhaus Isıtma ve Soğutma Sistemleri San. Tic. A.Ş or be copied or otherwise utilized by anybody without expressed written permission.
Release date: 20/04/2017		
Rev. No: 0		
Drw. No: WH.17.075		

Table 4.19 Procedure WH.17.075

#### 4.24 Lawa Plus / Priwa Plus / Enerwa Plus Wall-Hung Boilers DHW Preheat Mode



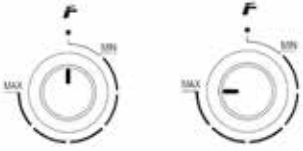
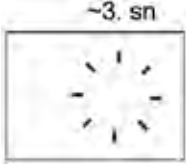
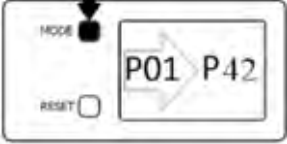

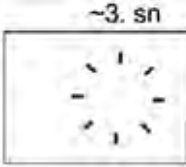
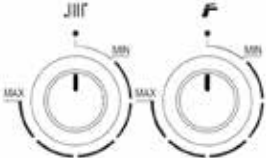
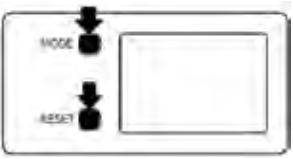
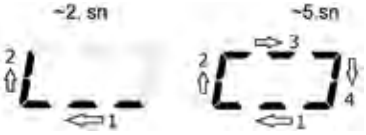
DHW Preheat Mode		
Designation: Lawa Plus / Priwa Plus / Enerwa Plus wall-hung boilers		
Object	Type-model / Technical data	Mark (s) of conformity
Procedure DHW Preheat Mode		Lawa Plus 24-28 / Priwa Plus 24-28-33 / Enerwa Plus 24-28-33 granted by Warmhaus R&D
Pos No	Operation	Description GB
0		<b>Attention:</b> This procedure must be applied by authorized persons.
1		Press the RESET and CH (-) button simultaneously.
2		Wait until the approval circle complete on the LCD and release buttons
3		The screen will appear tSP - Parameter = 01 - Value = 0 <b>Attention:</b> Do not change this parameter
4		From this moment toggle CH (+) to increase to find P18
5		Ones you reach the parameter P18, Change the parameter VALUE by using the DHW (+) or DHW (-) buttons. Set the P18 = 0. This is preparation for Preheat function.
6		Push the RESET button to save the adjusted value. Wait until the approval circle complete on the LCD and release button.
7		From this moment toggle CH (+) to increase to find P27
8		Ones you reach the parameter P27 to change the parameter VALUE by using the DHW (+) or DHW (-) buttons. Set the P27 = 52 (if DHW inlet temperature is colder than 12 °C then you can set the P27 = 55). This is preparation for Preheat function.
9		Push the RESET button to save the adjusted value. Wait until the approval circle complete on the LCD and release button.
10		From this moment toggle CH (+) to increase to find P42
11		Ones you reach the parameter P42 to change the parameter VALUE by using the DHW (+) or DHW (-) buttons. Set the P42 = 1, this will allow the preheat Enabled
12		To exit the TSP menu push the RESET and CH (-) simultaneously.
13		Wait until the approval circle complete on the LCD and release buttons. Pre heat will enable first request of DHW.
Author: İsmail B. Taşdemir / R&D Manager		As this is the property of Warmhaus Isıtma ve Sogutma Sistemleri San. Tic. A.Ş. It must not be passed on to any person not authorized by Warmhaus Isıtma ve Sogutma Sistemleri San. Tic. A.Ş or be copied or otherwise utilized by anybody without expressed written permission.
Release date: 20/04/2017		
Rev. No: 0		
Drw. No: WH.17.076		

Table 4.20 Procedure WH.17076

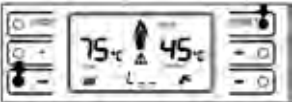
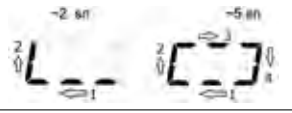

**4.24.1 Lawa Plus 24-28 / Priwa Plus 24-28-33/  
Enerwa Plus 24-28-33 wall-hung boilers DHW preheat mode short cut**

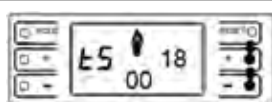
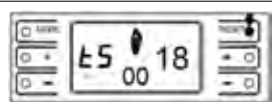
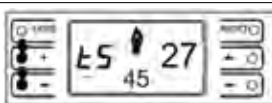

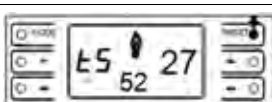
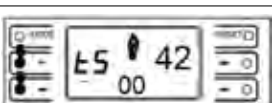
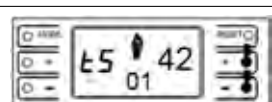
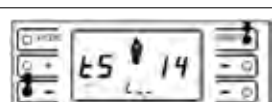
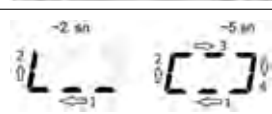



DHW Preheat Mode Short Cut			
Designation: Lawa Plus / Priwa Plus / Enerwa Plus wall-hung boilers			
Object	Type-model / Technical data		Mark (s) of conformity
Procedure DHW Preheat Mode		Lawa Plus 24-28 / Priwa Plus 24-28-33 / Enerwa Plus 24-28-33	granted by Warmhaus R&D
Pos No	Operation	Description GB	
0		If the preheat adjustments has been done by service technician then it's possible to ACTIVATE via buttons by user.	
1		When the boiler on WINTER or SUMMER mode then, push the RESET button to enable the Preheat. (There should be no Error code present on the screen)	
2		Wait until the approval circle complete on the LCD and release buttons.	
3		"Pre - ON" will be displayed on the screen. Preheat function is enabled.	
4		If the preheat adjustments has been done by service technician then it's possible to DE ACTIVATE via buttons by user.	
5		When the boiler on WINTER or SUMMER mode then, push the RESET button to enable the Preheat. (There should be no Error code present on the screen)	
6		Wait until the approval circle complete on the LCD and release buttons.	
7		"Pre - OFF" will be displayed on the screen. Preheat function is disabled.	
Author: İsmail B. Taşdemir / R&D Manager		As this is the property of Warmhaus Isıtma ve Sogutma Sistemleri San. Tic. A.Ş. It must not be passed on to any person not authorized by Warmhaus Isıtma ve Sogutma Sistemleri San. Tic. A.Ş or be copied or otherwise utilized by anybody without expressed written permission	
Release date: 20/04/2017			
Rev. No: 0			
Drw. No: WH.17.077			

Table 4.21 Procedure WH.17.077

## 4.25 Lawa / Priwa / Enerwa Wall-Hung Boilers On-Off Mode

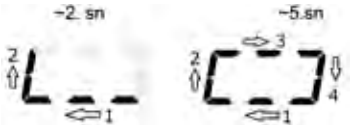

ON-OFF MODE		
Designation: Lawa / Priwa / Enerwa wall-hung boilers		
Object	Type-model / Technical data	Mark (s) of conformity
Procedure ON / OFF	Lawa 24-28 / Priwa 24-28-33 / Enerwa 24-28-33	granted by Warmhaus R&D
Pos No	Operation	Description GB
0		By Pressing MODE button to select switch mode of the boiler. MODE order is WINTER - SUMMER - OFF circle
1		Wait until the approval circle complete on the LCD and release buttons.
2		Make sure that the "OFF" is displayed on the screen. If not press again the "MODE" and repeat the step above.
3		On the display OFF symbol shown.
4		to Switch boiler WINTER MODE - ON press and hold the "MODE" button again.
5		Wait until the approval circle complete on the LCD and release buttons.
6		WINTER MODE - ON: On the LCD radiator and tap symbol displayed together and if central heating request the radiator symbol blinks.
7		To Switch boiler SUMMER MODE - ON press and hold the "MODE" button again.
8		Wait until the approval circle complete on the LCD and release buttons.
9		SUMMER MODE - ON: On the LCD radiator and only tap symbol displayed. If DHW request the tap symbol blinks.
Author: İsmail B. Taşdemir / R&D Manager		As this is the property of Warmhaus Isıtma ve Soğutma Sistemleri San. Tic. A.Ş. It must not be passed on to any person not authorized by Warmhaus Isıtma ve Soğutma Sistemleri San. Tic. A.Ş or be copied or otherwise utilized by anybody without expressed written permission.
Release date: 20/04/2017		
Rev. No: 0		
Drw. No: WH.17.078		

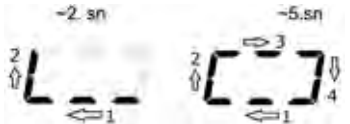
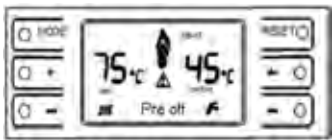
Table 4.22 Procedure WH.17.078





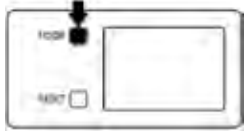
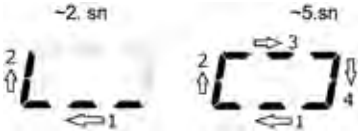

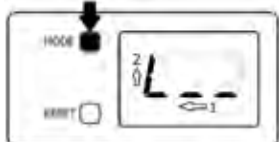
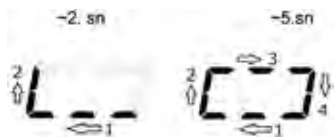
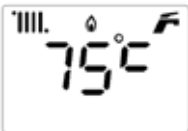
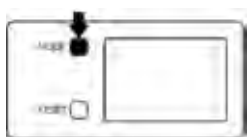
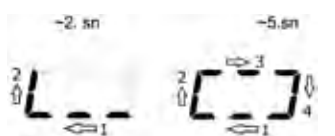
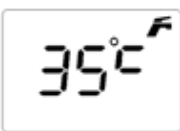
ON-OFF MODE			
Designation: Lawa Plus / Priwa Plus / Enerwa Plus			
Object		Type-model / Technical data	
Procedure setting or checking TsP parameters		Lawa Plus 24-28 / Priwa Plus 24-28-33 / Enerwa Plus 24-28-33	granted by Warmhaus R&D
Pos No	Operation	Description GB	
0		By Pressing MODE button to select switch mode of the boiler. MODE order is WINTER - SUMMER - OFF circle	
1		Wait until the approval circle complete on the LCD and release buttons.	
2		Make sure that the "OFF" is displayed on the screen. If not press again the "MODE" and repeat the step above.	
3		On the display OFF symbol shown.	
4		to Switch boiler WINTER MODE - ON press and hold the "MODE" button again.	
5		Wait until the approval circle complete on the LCD and release buttons.	
6		WINTER MODE - ON: On the LCD radiator and tap symbol displayed together and if central heating request the radiator symbol blinks.	
7		to Switch boiler SUMMER MODE - ON press and hold the "MODE" button again.	
8		SUMMER MODE - ON: On the LCD radiator and only tap symbol displayed. If DHW request the tap symbol blinks.	
Author: İsmail B. Taşdemir / R&D Manager		As this is the property of Warmhaus Isıtma ve Sogutma Sistemleri San. Tic. A.Ş. It must not be passed on to any person not authorized by Warmhaus Isıtma ve Sogutma Sistemleri San. Tic. A.Ş or be copied or otherwise utilized by anybody without expressed written permission	
Release date: 20/04/2017			
Rev. No: 0			
Drw. No: WH.17.079			

Table 4.23 Procedure WH.17079

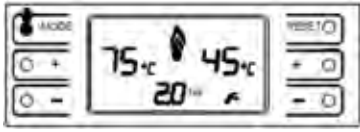
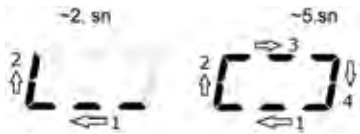
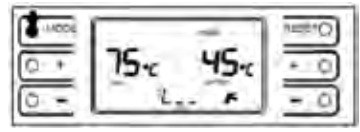
#### 4.27 All Wall-Hung Boilers SGV Gas Valve Electrical Resistance

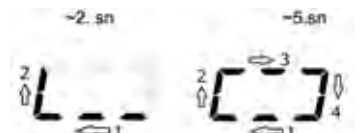
SGV Gas Valve Electrical Resistance			
Designation: All wall-hung boilers, 2% Sampling			
Object	Manufacturer	Type-model / Technical data	Mark (s) of conformity
SGV Gas Valve Electrical Resistance	Warmhaus	All Wall-hung boilers	granted by Warmhaus R&D

SGV Gas valve electrical resistance for all Warmhaus boilers (standart efficiency & condensing) given below;  
 SGV Gas valve electrical resistance must be checked incoming quality control 2% and checked 100% end of line;

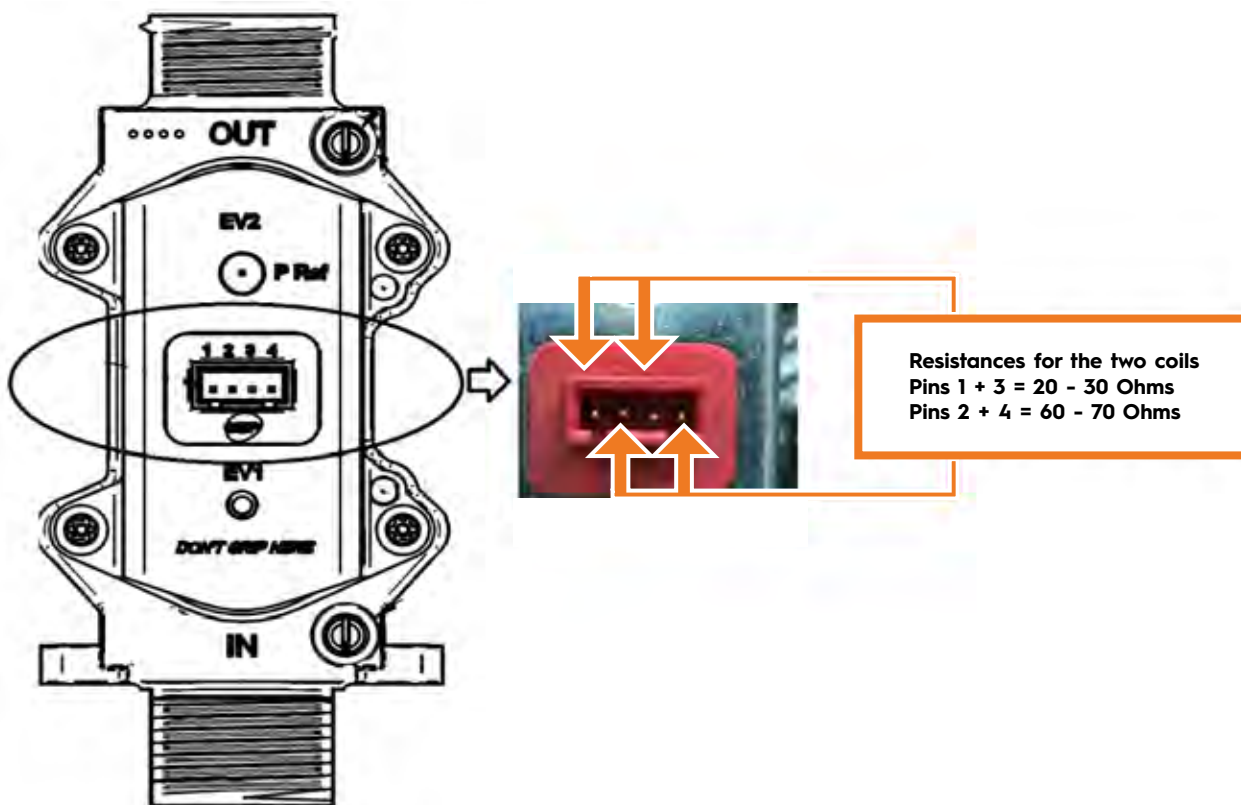

5 pcs of SGV Gas valve electrical resistance has been checked and all the valves are within the default values;

SGV Sample	Pin 1-3 Resistance	Pin 2-4 Resistance
	Ω - OHMS	Ω - OHMS
1	23,2	65
2	23,2	64,8
3	23,3	65
4	23,3	65
5	23,3	65,2
<b>Default Values</b>	<b>20 - 30</b>	<b>60 - 70</b>

Author: İsmail B. Taşdemir / R&D Manager	As this is the property of Warmhaus Isıtma ve Sogutma Sistemleri San. Tic. A.Ş. It must not be passed on to any person not authorized by Warmhaus Isıtma ve Sogutma Sistemleri San. Tic. A.Ş or be copied or otherwise utilized by anybody without expressed written permission.
Release date: 20/04/2017	
Rev. No: 0	
Drw. No: WH.17.110	

Figure 4.14

Return NTC Electrical Resistance			
Designation: All wall-hung boilers, 2% Sampling			
Object	Manufacturer	Type-model / Technical data	Mark (s) of conformity
Return NTC Electrical Resistance	Warmhaus	All Wall2hung boilers	granted by Warmhaus R&D

Return NTC electrical resistance for all Warmhaus boilers (standart efficiency & condensing) given below;  
 Return NTC electrical resistance must be checked incoming quality control 2% and checked function 100% end of line;

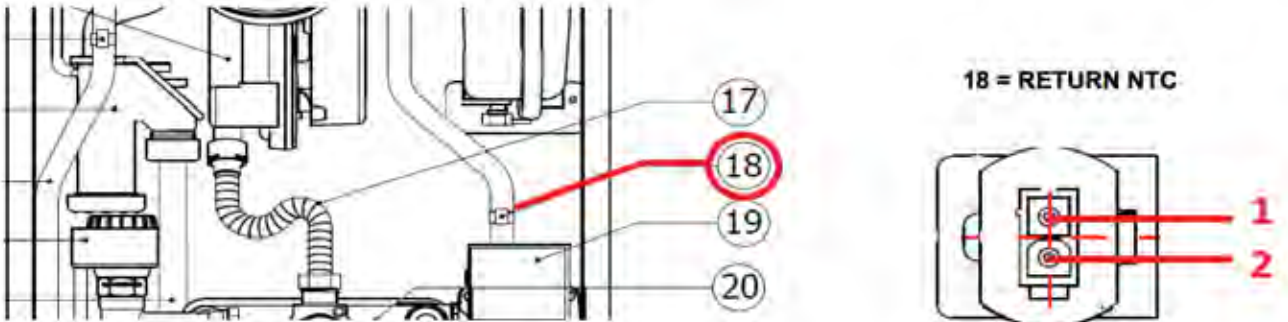

Technical Specifications of NTC;

NTC thermistor  
 type VME/10K/±3%  
 single 2-wire  
 10KOhm at 25°C  
 Bvalue 3977  
 range 0..+100°C  
 tolerance 3% at 60°C

Measurement points 1-2 with multimeter;

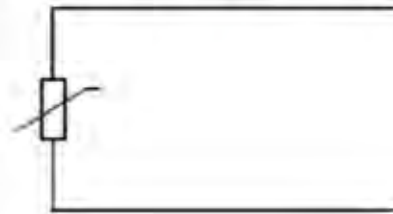

Measurement range for Return NTC has been given below with the chart and table;

T (°C)	R (Ohm)
0	32650
5	25388
10	19900
15	15709
20	12490
25	10000
30	8057
35	6531
40	5327
45	4369
50	3603
55	2986
60	2488
65	2083
70	1752
75	1481
80	1258
85	1072
90	918
95	789
100	680

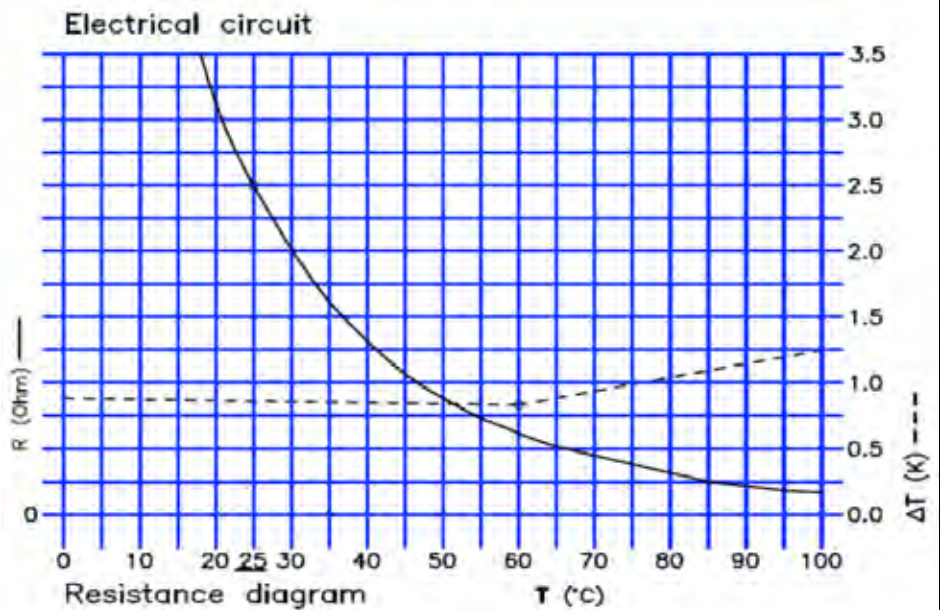

Author: İsmail B. Taşdemir / R&D Manager  
 Release date: 20/04/2017  
 Rev. No: 0  
 Drw. No: WH.17.111

As this is the property of Warmhaus Isıtma ve Soğutma Sistemleri San. Tic. A.Ş. It must not be passed on to any person not authorized by Warmhaus Isıtma ve Soğutma Sistemleri San. Tic. A.Ş or be copied or otherwise utilized by anybody without expressed written permission.

Figure 4.15

## 4.29 All Wall-Hung Boilers Flow & Limit Thermostat NTC Electrical Resistance

Flow&Limit Thermostat NTC Electrical Resistance			
Designation: All wall-hung boilers, 2% Sampling			
Object	Manufacturer	Type-model / Technical data	Mark (s) of conformity
Flow & Safety Limit T. NTC Electrical Resistance	Warmhaus	All Wall-hung boilers	granted by Warmhaus R&D

Flow & Safety Limit Thermostat NTC electrical resistance for all Warmhaus boilers (standart efficiency & condensing) given below; Flow & (SLT) NTC electrical resistance must be checked incoming quality control 2% and checked function 100% end of line;

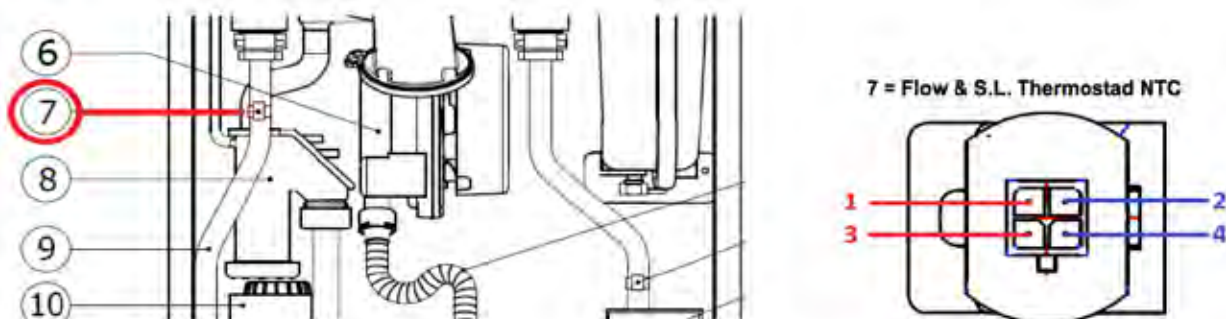

### Technical Specifications of NTC;

NTC thermistor  
type VME/10K/±3%  
duplex 4-wire  
10KOhm at 25°C  
Bvalue 3977K  
range 0..+100°C  
tolerance 3% at 60°C

Measurement points 1-3\* OR 2-4\*\* with multimeter;

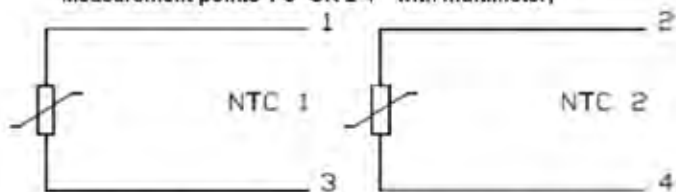

\* NTC 1 used as Safety Limit Thermostat ( 1 - 3 )

\*\* NTC 2 used as Flow Temperature Sensor ( 2 - 4 )

Measurement range for Flow & Safety Limit Thermostat NTC has been given below with the chart and table;

T (°C)	R (Ohm)
0	32624
5	25381
10	19897
15	15711
20	12493
25	10000
30	8056
35	6530
40	5324
45	4365
50	3599
55	2982
60	2483
65	2079
70	1748
75	1476
80	1252
85	1066
90	912
95	782
100	674

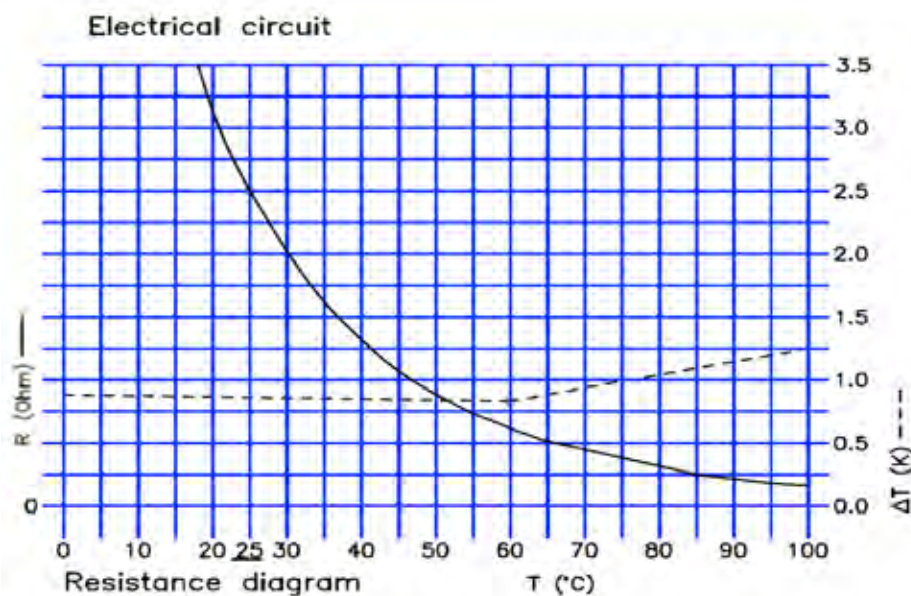

Author: İsmail B. Taşdemir / R&D Manager

Release date: 20/04/2017

Rev. No: 0

Drw. No: WH.17.112

As this is the property of Warmhaus Isıtma ve Sogutma Sistemleri San. Tic. A.Ş. It must not be passed on to any person not authorized by Warmhaus Isıtma ve Sogutma Sistemleri San. Tic. A.Ş or be copied or otherwise utilized by anybody without expressed written permission.

Figure 4.16

Domestic Hot Water NTC Electrical Resistance			
Designation: All wall-hung boilers, 2% Sampling			
Object	Manufacturer	Type-model / Technical data	Mark (s) of conformity
Domestic Hot Water NTC Electrical Resistance	Warmhaus	All Wall-hung boilers	granted by Warmhaus R&D

Domestic Hot Water (DHW) NTC electrical resistance for all Warmhaus boilers (standart efficiency & condensing) given below; DHW NTC electrical resistance must be checked incoming quality control 2% and checked function 100% end of line;

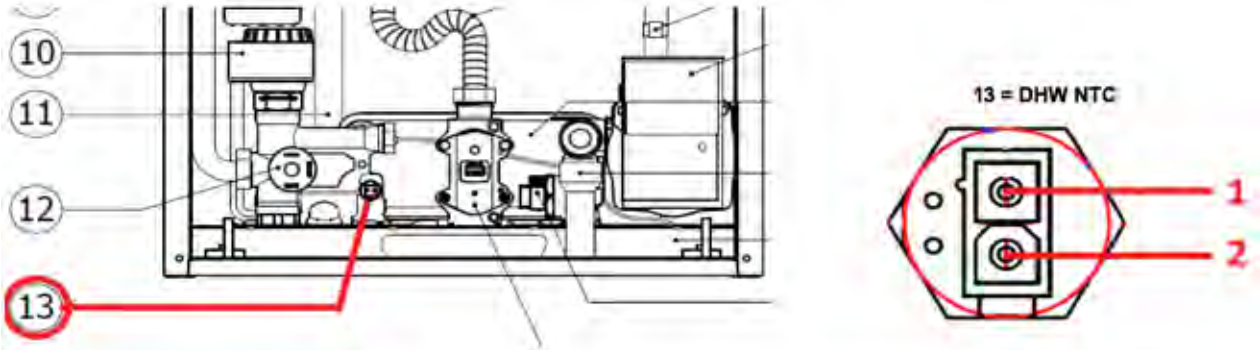

**Technical Specifications of NTC:**

NTC thermistor  
 type SNTC/10KF40  
 single 2-wire  
 10KOhm at 25°C  
 Bvalue 3977  
 range 0..+90°C  
 tolerance at  
 0- 70°C ±0.2°C  
 70-100°C ±0.5°C

**Measurement points 1-2 with multimeter;**



Measurement range for Domestic Hot Water NTC has been given below with the chart and table;

T (°C)	R (Ohm)
0	32650
5	25388
10	19900
15	15709
20	12490
25	10000
30	8057
35	6531
40	5327
45	4369
50	3603
55	2986
60	2488
65	2083
70	1752
75	1481
80	1258
85	1072
90	918
95	789
100	680

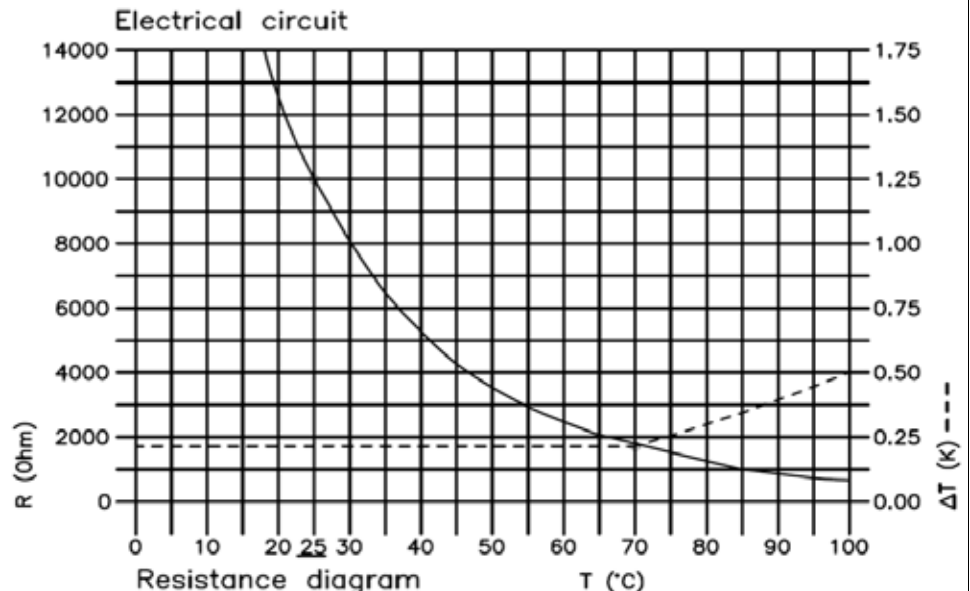

Author: İsmail B. Taşdemir / R&D Manager	As this is the property of Warmhaus Isıtma ve Sogutma Sistemleri San. Tic. A.Ş. It must not be passed on to any person not authorized by Warmhaus Isıtma ve Sogutma Sistemleri San. Tic. A.Ş or be copied or otherwise utilized by anybody without expressed written permission.
Release date: 20/04/2017	
Rev. No: 0	
Drw. No: WH.17.113	

Figure 4.17

### 4.31 All Wall-Hung Boilers Gas NTC Electrical Resistance

Flue Gas NTC Electrical Resistance			
Designation: All wall-hung boilers, 2% Sampling			
Object	Manufacturer	Type-model / Technical data	Mark (s) of conformity
Flue Gas NTC Electrical Resistance	Warmhaus	All Wall-hung boilers	granted by Warmhaus R&D

Flue Gas NTC electrical resistance for all Warmhaus boilers (standart efficiency & condensing) given bellow;  
 Flue Gas NTC electrical resistance must be checked incoming quality control 2% and checked function 100% end of line;

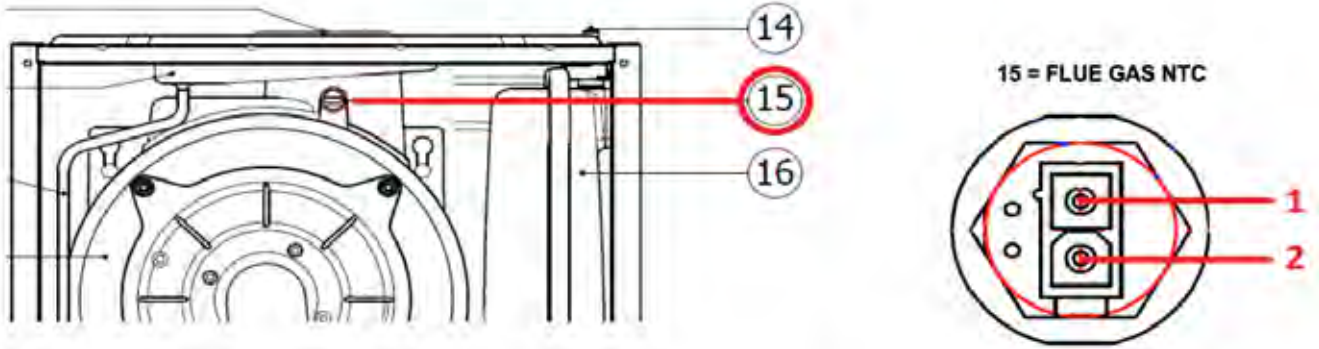

**Technical Specifications of NTC;**

NTC thermistor  
 type 20KOhm 1%  
 single 2-wire  
 20KOhm at 25°C  
 Bvalue 3970  
 range -20.,+125°C  
 max. temp. tip 150°C  
 tolerance 1% at 25°C

**Measurement points 1-2 with multimeter;**



Measurement range for Flue Gas NTC has been given bellow with the chart and table;

T (°C)	R (Ohm)
0	66050
10	40030
20	25030
25	20000
30	16090
40	10610
50	7166
60	4943
70	3478
80	2492
90	1816
100	1344
110	1009
120	768
130	592
140	461
150	364
160	290
170	233
180	189
190	155

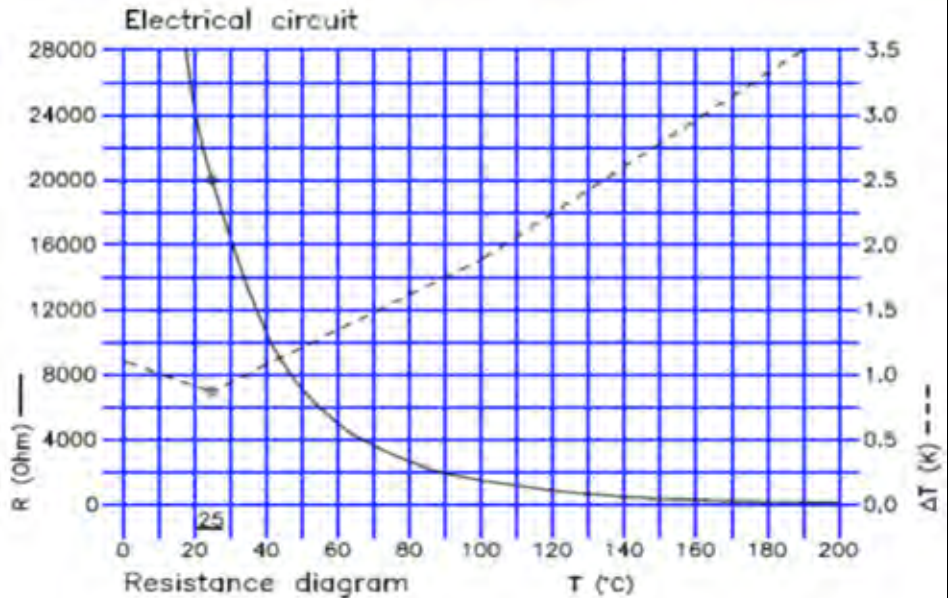

Author: İsmail B. Taşdemir / R&D Manager	As this is the property of Warmhaus Isıtma ve Sogutma Sistemleri San. Tic. A.Ş. It must not be passed on to any person not authorized by Warmhaus Isıtma ve Sogutma Sistemleri San. Tic. A.Ş or be copied or otherwise utilized by anybody without expressed written permission.
Release date: 20/04/2017	
Rev. No: 0	
Drw. No: WH.17.114	

Figure 4.18



### 4.32 Priwa / Enerwa Wall-Hung Boilers Gas Conversation From NG (G20) To LPG (G31)

Gas Conversation from NG (G20) to LPG (G31)		
Designation: Priwa / Enerwa wall-hung boilers		
Object	Type-model / Technical data	Mark (s) of conformity
Procedure Gas Conversion from Natural gas to LPG		Priwa 24-28-33 / Enerwa 24-28-33
granted by Warmhaus R&D		
Pos No	Operation	Description GB
0		<b>Attention:</b> This procedure must be applied by authorized persons and valid for only condensing boiler. <b>Attention:</b> Gas inlet pressure must be 37 mbar for LPG (G31) <b>Attention:</b> Do not ever change gas inlet pressure during calibration or after calibration
1		Set both knobs at MIN position
2		Push two button MODE + RESET simultaneously
3		Wait until the approval circle complete on the LCD and release buttons
4		The screen will appear tSP - P01 - 0 <b>Attention:</b> Do not change this parameter
5		From this moment increase the parameter by using MODE to reach P02
6		Ones you reach P02, on the screen turn the DHW knob to MAX position
7		Now you are able to change the parameter. Adjust the parameter value by using MODE to increase value
8		Ones you reach desired value P02 = 1 move DHW knob at MIN position and then after MAX position (SWING)
9		The value you set on the screen will flashing after this SWING. Ones the flashing stop the value is SAVED.
10		Move the DHW button at MIN position
11		At this point on the screen shows TsP – P02 – 1
12		Make sure both knobs at MIN position
13		Push two button MODE + RESET simultaneously
14		Wait until the approval circle complete on the LCD and release buttons. In this way EXIT the TsP Menu.
15		Switch off the boiler from fuse wait 20 seconds. Switch on the boiler from fuse
16		Just after boiler switched on first boiler power will appear on the LCD as 24,28 or 33 then after the gas type adjusted will appear as LPG = G31
Author: İsmail B. Taşdemir / R&D Manager		As this is the property of Warmhaus Isıtma ve Sogutma Sistemleri San. Tic. A.Ş. It must not be passed on to any person not authorized by Warmhaus Isıtma ve Sogutma Sistemleri San. Tic. A.Ş or be copied or otherwise utilized by anybody without expressed written permission.
Release date: 20/04/2017		
Rev. No: 0		
Drw. No: WH.17.080		

Table 4.24 Procedure WH.17080

### 4.33 Priwa Plus / Enerwa Plus Wall-Hung Boilers Gas Conversation From NG (G20) To LPG (G31)









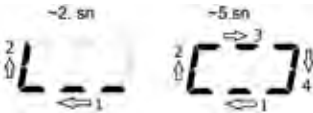

Gas Conversation from NG (G20) to LPG (G31)			
Designation: Priwa Plus / Enerwa Plus wall-hung boilers			
Object		Type-model / Technical data	
Procedure Gas Conversion from Natural gas to LPG		Priwa Plus 24-28-33 / Enerwa Plus 24-28-33	granted by Warmhaus R&D
Pos No	Operation	Description GB	
0		<p><b>Attention:</b> This procedure must be applied by authorized persons and valid for only condensing boiler.</p> <p><b>Attention:</b> Gas inlet pressure must be 37 mbar for LPG (G31)</p> <p><b>Attention:</b> Do not ever change gas inlet pressure during calibration or after calibration</p>	
1		Press the RESET and CH (-) button simultaneously.	
2		Wait until the approval circle complete on the LCD and release buttons	
3		The screen will appear tSP - Parameter = 01 - Value = 0 <b>Attention:</b> do not change this parameter	
4		From this moment toggle CH (+) to increase reach the Parameter P02 aimed to be changed.	
5		Ones you reach the parameter aimed to be changed, change the parameter VALUE by using the DHW (+) and set P02=1.	
6		"Push the RESET button to save the adjusted value. Wait until the approval circle complete on the LCD and release button."	
7		Wait until the approval circle complete on the LCD and release button.	
8		To exit the TSP menu push the RESET and CH (-) simultaneously.	
9		Wait until the approval circle complete on the LCD and release buttons. In this way EXIT the TsP Menu.	
10		Switch off the boiler from fuse wait 20 seconds. Switch on the boiler from fuse	
11		Just after boiler switched on first boiler power will appear on the LCD as 24,28 or 33 then after the gas type adjusted will appear as LPG = G31	
Author: İsmail B. Taşdemir / R&D Manager		As this is the property of Warmhaus Isıtma ve Sogutma Sistemleri San. Tic. A.Ş. It must not be passed on to any person not authorized by Warmhaus Isıtma ve Sogutma Sistemleri San. Tic. A.Ş or be copied or otherwise utilized by anybody without expressed written permission.	
Release date: 20/04/2017			
Rev. No: 0			
Drw. No: WH.17.081			

Table 4.25 Procedure WH.17.081

#### 4.34 Priwa / Enerwa Wall-Hung Boilers Gas Conversation From LPG (G31) To NG (G20)

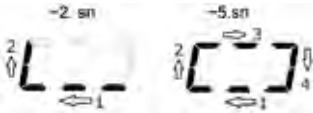
Gas Conversation from LPG (G31) to NG (G20)		
Designation: Priwa / Enerwa wall-hung boilers		
Object	Type-model / Technical data	Mark (s) of conformity
Procedure Gas Conversion from LPG to Natural gas		Priwa 24-28-33 / Enerwa 24-28-33
granted by Warmhaus R&D		
Pos No	Operation	Description GB
0		<b>Attention:</b> This procedure must be applied by authorized persons and valid for only condensing boiler. <b>Attention:</b> Gas inlet pressure must be 20 mbar for Naturalgas (G20) <b>Attention:</b> Do not ever change gas inlet pressure during calibration or after calibration
1		Set both knobs at MIN position
2		Push two button MODE + RESET simultaneously
3		Wait until the approval circle complete on the LCD and release buttons
4		The screen will appear tSP - P01 - 0 <b>Attention:</b> do not change this parameter
5		From this moment increase the parameter by using MODE to reach P02
6		Ones you reach P02, on the screen turn the DHW knob to MAX position
7		Now you are able to change the parameter. Adjust the parameter value by using MODE to increase value
8		Ones you reach desired value P02 = 0 move DHW knob at MIN position and then after MAX position (SWING)
9		The value you set on the screen will flashing after this SWING. Ones the flashing stop the value is SAVED.
10		Move the DHW button at MIN position
11		At this point on the screen shows TsP – P02 – 0
12		Make sure both knobs at MIN position
13		Push two button MODE + RESET simultaneously
14		Wait until the approval circle complete on the LCD and release buttons. In this way EXIT the TsP Menu.
15		Switch off the boiler from fuse. Wait 20 seconds. Switch on the boiler from fuse
16		Just after boiler switched on first boiler power will appear on the LCD as 24,28 or 33 then after the gas type adjusted will appear as nG = natural gas G20
Author: İsmail B. Taşdemir / R&D Manager		As this is the property of Warmhaus Isıtma ve Sogutma Sistemleri San. Tic. A.Ş. It must not be passed on to any person not authorized by Warmhaus Isıtma ve Sogutma Sistemleri San. Tic. A.Ş or be copied or otherwise utilized by anybody without expressed written permission.
Release date: 20/04/2017		
Rev. No: 0		
Drw. No: WH.17.082		

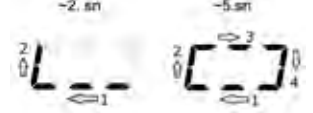
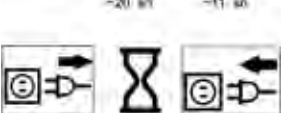
Table 4.26 Procedure WH.17.082

### 4.35 Priwa Plus / Enerwa Plus Wall-Hung Boilers Gas Conversation From LPG (G31) To NG (G20)







Gas Conversation from LPG (G31) to NG (G20)		
Designation: Priwa Plus / Enerwa Plus wall-hung boilers		
Object	Type-model / Technical data	Mark (s) of conformity
Procedure Gas Conversion from LPG to Natural gas		Priwa Plus 24-28-33 / Enerwa Plus 24-28-33 granted by Warmhaus R&D
Pos No	Operation	Description GB
0		<b>Attention:</b> This procedure must be applied by authorized persons and valid for only condensing boiler. <b>Attention:</b> Gas inlet pressure must be 20 mbar for Natural gas (G20). <b>Attention:</b> Do not ever change gas inlet pressure during calibration or after calibration.
1		Press the RESET and CH (-) button simultaneously.
2		Wait until the approval circle complete on the LCD and release buttons
3		The screen will appear tSP - Parameter = 01 - Value = 0 <b>Attention:</b> Do not change this parameter
4		From this moment toggle CH (+) to increase reach the Parameter P02 aimed to be changed.
5		Ones you reach the parameter aimed to be changed, change the parameter VALUE by using the DHW (-) and set P02=0.
6		"Push the RESET button to save the adjusted value. Wait until the approval circle complete on the LCD and release button."
7		Wait until the approval circle complete on the LCD and release button.
8		To exit the TSP menu push the RESET and CH (-) simultaneously.
9		Wait until the approval circle complete on the LCD and release buttons. In this way EXIT the TsP Menu.
10		Switch off the boiler from fuse. Wait 20 seconds. Switch on the boiler from fuse.
11		Just after boiler switched on first boiler power will appear on the LCD as 24,28 or 33 then after the gas type adjusted will appear as LPG = G31
Author: İsmail B. Taşdemir / R&D Manager		As this is the property of Warmhaus Isıtma ve Sogutma Sistemleri San. Tic. A.Ş. It must not be passed on to any person not authorized by Warmhaus Isıtma ve Sogutma Sistemleri San. Tic. A.Ş or be copied or otherwise utilized by anybody without expressed written permission.
Release date: 20/04/2017		
Rev. No: 0		
Drw. No: WH.17.083		

Table 4.27 Procedure WH.17.083

Max CH Power Adjustment via P06 - P08			
Designation: All Warmhaus Wall-hung Boilers			
Object	Manufacturer	Type-model / Technical data	Mark (s) of conformity
Burner control	BERTELLI	All Wall-hung boilers	granted by Warmhaus R&D

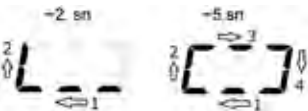
This document has been composed to adjust output power via software by using TsP (Transparent Parameter Menu)

**Attention:** This procedure must be applied by authorized persons and P06 parameter valid for only atmospheric boilers.

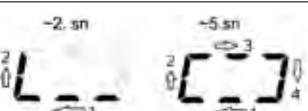
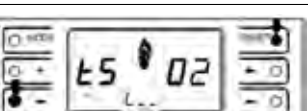
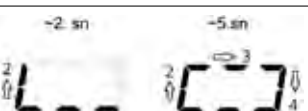
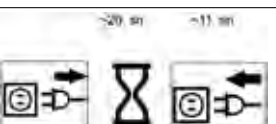
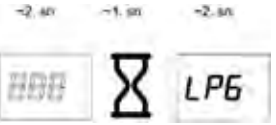
**Attention:** This procedure must be applied by authorized persons and P08 parameter valid for only condensing boilers.

CH Output power	Lawa 24	Lawa 28	Priwa 24	Priwa 28	Priwa 33	CH Output power
	Lawa Plus 24	Lawa Plus 28	Priwa Plus 24	Priwa Plus 28	Priwa Plus 33	
			Enerwa 24	Enerwa 28	Enerwa 33	
			Enerwa Plus 24	Enerwa Plus 28	Enerwa Plus 33	
	P06 value %	P06 value %	P08 value %	P08 value %	P08 value %	
3 kW	N/A	N/A	0	N/A	N/A	3 kW
3,5 kW			5	0		3,5 kW
4 kW			6	3	0	4 kW
5 kW			7	6	3	5 kW
6 kW			10	8	5	6 kW
7 kW	0		14	11	8	7 kW
8 kW	17	0	20	14	12	8 kW
9 kW	24	5	24	17	15	9 kW
10 kW	30	18	28	20	18	10 kW
11 kW	35	24	31	23	21	11 kW
12 kW	42	31	35	26	25	12 kW
13 kW	50	37	39	29	28	13 kW
14 kW	60	52	42	32	31	14 kW
15 kW	64	55	46	35	34	15 kW
16 kW	69	58	50	38	36	16 kW
17 kW	74	63	53	41	38	17 kW
18 kW	78	67	56	45	40	18 kW
19 kW	82	70	60	48	42	19 kW
20 kW	87	74	63	52	44	20 kW
21 kW	90	78	66	55	47	21 kW
22 kW	95	81	69	58	50	22 kW
23 kW	98	83	71	61	54	23 kW
24 kW	100	86	73	64	57	24 kW
25 kW	N/A	90	N/A	69	60	25 kW
26 kW		92		72	63	26 kW
27 kW		96		76	66	27 kW
28 kW		100		80	69	28 kW
29 kW					72	29 kW
30 kW					75	30 kW
31 kW					78	31 kW
32 kW					80	32 kW
33 kW					82	33 kW
34 kW				N/A		N/A
35 kW					35 kW	
36 kW					36 kW	
37 kW					37 kW	
38 kW					38 kW	
39 kW					39 kW	
40 kW					40 kW	

**Attention:** The values given in this table are approximate.  
All values given on the table; based on 80°C flow and 60°C return temperature.

Author: İsmail B. Taşdemir / R&D Manager	As this is the property of Warmhaus Isıtma ve Sogutma Sistemleri San. Tic. A.Ş. It must not be passed on to any person not authorized by Warmhaus Isıtma ve Sogutma Sistemleri San. Tic. A.Ş or be copied or otherwise utilized by anybody without expressed written permission.
Release date: 20/04/2017	
Rev. No: 0	
Drw. No: WH.17.091	

Table 4.28 Procedure WH.17.091

## 4.37 Technical Datas

TECHNICAL DATA	UNIT	2530 C			3035 C			3540 C		
		Priwa-ErP 24/31 & Priwa Plus 24/31			Priwa-ErP 28/35 & Priwa Plus 28/35			Enerwa-ErP 33/40 & Enerwa Plus-ErP 33/40		
CE Certification		CE-1015CR0544: 16			CE-1015CS0553: 17			CE-1015CS0565: 17		
Gas Circuit										
Gas Type		G20	G25	G33	G20	G25	G31	G20	G25	G31
Gas Supply Pressure	mbar	20	25	37	20	25	37	20	25	37
Gas Consumption at Maximum	m³/h	2.38*	2.85	0.92	3.05*	3.47	1.18	3.402	4.127	1.302
Gas Consumption at Minimum	m³/h	0.37*	0.43	0.11	0.397*	0.456	0.144	0.434	0.524	0.168
*(Natural Gas G20) Heat Load (Hu=10.56 kWh/m³)										
Premix System		Gas Adaptive			Gas Adaptive			Gas Adaptive		
Modulation Range		1:10			1:10			1:10		
Heat Exchanger Material		Stainless steel			Stainless steel			Stainless steel		
Efficiency		G20	G25	G31	G20	G25	G31	G20	G25	G31
(80/60 °C) Efficiency at Maximum Heat Output	%	98.03	97.84	97.76	97.88	98.15	98.59	98.00	98.23	98.04
(50/30 °C) Efficiency at Maximum Heat Output	%	105.11	105.34	103.63	105.0	104.26	104.67	105.4	105.53	105.43
Efficiency at 30% load at 36/30 °C	%	108.29	108.38	108.29	107.54	107.83	107.36	107.2	107.06	106.98
Seasonal Space Heating Energy Efficiency (expressed in terms of GCV)	%	90 (Class A)			90 (Class A)			91 (Class A)		
Radiator Circuit		G20	G25	G31	G20	G25	G31	G20	G25	G31
Maximum Heat Input Qn	kW	24.25	24.25	24.25	28.7	29	29.4	33.7	33.7	33.7
Minimum Heat Input Qn	kW	3.5	3.5	2.8	3.75	3.82	3.59	4.35	4.35	4.35
Maximum Heat Output Pn (80/60 °C)	kW	23.7	23.7	23.7	28	28	28.01	33.02	33.02	33.02
Minimum Heat Output Pn (80/60 °C)	kW	3	3	2.5	3.5	3.5	3.45	4.1	4.1	4.1
Maximum Heat Output Pn (50/30 °C)	kW	25	25	25	30	30	28.63	35.5	35.5	35.5
Minimum Heat Output Pn (50/30 °C)	kW	3.6	3.6	2.9	3.90	3.90	3.59	4.60	4.60	4.60
Temperature Selection Range (min-max) High Temperature	°C	25÷80			25÷80			25÷80		
Temperature Selection Range (min-max) Low Temperature	°C	25÷47			25÷47			25÷47		
Operating Pressure (Maximum)	bar	3			3			3		
Operating Pressure (Minimum)	bar	0.5			0.5			0.5		
Expansion Tank Useful Volume	ℓ	8			10			10		
Pump Pressure (at 1000 l/h flow rate)	mH <sub>2</sub> O	6.1			6.1			5.5		
Pump Pressure (at 500 l/h flow rate)	mH <sub>2</sub> O	6.5			6.5			7.8		
Max. Pump Flow Rate	ℓ/h	2500			2500			2400		
Domestic Hot Water Circuit										
Maximum DHW Heat Input	kW	31.15			35			38.8		
Minimum DHW Heat Input	kW	3.5			3.75			4.35		
Max. Domestic Hot Water Flow Rate (Δt: 30 °C)	ℓ/min.	14.8			16.80			19.00		
Min. Domestic Hot Water Flow Rate (for the DHW function activation)	ℓ/min.	1.5			1.5			1.5		
Maximum Water Pressure	bar	10			10			10		
Minimum Water Pressure	bar	0.5			0.5			0.5		
Temperature Adjustment Range	°C	35 - 60			35 - 60			35 - 60		
Electricity Circuit										
Electricity Supply	V AC-50 Hz	230 V +%10; -%15			230 V +%10; -%15			230 V +%10; -%15		
Electricity Consumption (Max./Min.)	Watt	123 / 87			130 / 87			140 / 90		
Protection Index	IP	IPX5D			IPX5D			IPX5D		
Exhaust Gas Circuit		G20	G25	G31	G20	G25	G31	G20	G25	G31
Flue temperature (Qn)	°C									
(80/60 °C) Exhaust Gas Temperature (Min. / Max.)	°C	69.3 / 70.5	64.6 / 70.2	59.9 / 69.7	60.8 / 66.1	55.1 / 64.6	57.6 / 65.0	56.8 / 62.3	56.9 / 62.2	58.2 / 67.4
(50/30 °C) Exhaust Gas Temperature (Min. / Max.)	°C	48.5 / 50.5	47.7 / 49.4	47.0 / 50.5	44.5 / 44.5	44.0 / 44.1	43.4 / 44.9	46.8 / 44.2	46.7 / 44.5	48.7 / 48.9
Maximum Exhaust Gas Temperature [Maximum DHW mode]	°C	70			70			70		
NOx	Class	5			5			5		
Weighted Value of Nox (GCV)	mg/kWh	20	19	31	41	31	49	34	32	53
Flue Mass Flow Rate (60/80°C - Qn) Nominal/Minimum	g/s	10.32 / 1.6	10.78 / 1.62	9.91 / 1.18	13.23 / 1.72	13.13 / 1.73	12.71 / 1.62	14.76 / 1.88	15.54 / 1.97	14.03 / 1.81
Flue Mass Flow Rate (60/80°C - Qn) [Maximum DHW mode]	g/s	14.01	14.04	12.71	15.53	15.82	14.65	18.36	18.54	16.65
General										
Dimensions (H x W x D)	mm	725 x 420 x 288			725 x 420 x 288			725 x 420 x 288		
Sound Level	dB (A)	52			54			50		
Hydraulic Group Material		Brass			Brass			Brass		
Net Weight	kg	33			34.2			35		
Packed Device Weight	kg	35.2			36.4			37.2		
Type		C 13. C 33. C53. C63 C83			C 13. C 33. C53. C63 C83			C 13. C 33. C53. C63 C83		
Category		I2H (G20=20 mbar). I3P (G31=37 mbar)			I2H (G20=20 mbar). I3P (G31=37 mbar)			I2H (G20=20 mbar). I3P (G31=37 mbar)		

Table 4.29 Priwa / Priwa Plus Technical Table

TECHNICAL DATA	UNIT	Warmhaus								
		Enerwa-ErP 24/31 & Enerwa Plus-ErP 24/31			Enerwa-ErP 28/35 & Enerwa Plus-ErP 28/35			Enerwa-ErP 33/40 & Enerwa Plus-ErP 33/40		
CE Certification		CE-1015CR0544: 16			CE-1015CS0553: 17			CE-1015CS0565: 17		
Gas Circuit										
Gas Type		G20	G25	G31	G20	G25	G31	G20	G25	G31
Gas Supply Pressure	mbar	20	25	37	20	25	37	20	25	37
Gas Consumption at Maximum	m³/h	2.38*	2.85	0.92	3.05*	3.47	1.18	3.402	4.127	1.302
Gas Consumption at Minimum	m³/h	0.37*	0.43	0.11	0.397*	0.456	0.144	0.434	0.524	0.168
*(Natural Gas G20) Heat Load (Hu=10.56 kWh/m³)										
Premix System		Gas Adaptive			Gas Adaptive			Gas Adaptive		
Modulation Range		1:10			1:10			1:10		
Heat Exchanger Material		Stainless steel			Stainless steel			Stainless steel		
Efficiency		G20	G25	G31	G20	G25	G31	G20	G25	G31
(80/60 oC) Efficiency at Maximum Heat Output	%	98.03	97.84	97.76	97.88	98.15	98.59	98.00	98.23	98.04
(50/30 oC) Efficiency at Maximum Heat Output	%	105.11	105.34	103.63	105.0	104.26	104.67	105.4	105.53	105.43
Efficiency at 30% load at 36/30 °C	%	108.29	108.38	108.29	107.54	107.83	107.36	107.2	107.06	106.98
Seasonal Space Heating Energy Efficiency (expressed in terms of GCV)	%	91 (Class A)			91 (Class A)			91 (Class A)		
Radiator Circuit		G20	G25	G31	G20	G25	G31	G20	G25	G31
Maximum Heat Input Qn	kW	24.25	24.25	24.25	28.7	29	29.4	33.7	33.7	33.7
Minimum Heat Input Qn	kW	3.5	3.5	2.8	3.75	3.82	3.59	4.35	4.35	4.35
Maximum Heat Output Pn (80/60 °C)	kW	23.7	23.7	23.7	28	28	28.01	33.02	33.02	33.02
Minimum Heat Output Pn (80/60 °C)	kW	3	3	2.5	3.5	3.5	3.45	4.1	4.1	4.1
Maximum Heat Output Pn (50/30 °C)	kW	25	25	25	30	30	28.63	35.5	35.5	35.5
Minimum Heat Output Pn (50/30 °C)	kW	3.6	3.6	2.9	3.90	3.90	3.59	4.60	4.60	4.60
Temperature Selection Range (min-max) high temperature	°C	25-80			25-80			25-80		
Temperature Selection Range (min-max) low temperature	°C	25-47			25-47			25-47		
Operating Pressure (Maximum)	bar	3			3			3		
Operating Pressure (Minimum)	bar	0.5			0.5			0.5		
Expansion Tank Useful Volume	ℓ	8			10			10		
Pump Pressure (at 1000 l/h flow rate)	mH <sub>2</sub> O	5.5			5.5			5.5		
Pump Pressure (at 500 l/h flow rate)	mH <sub>2</sub> O	7.8			7.8			7.8		
Max. Pump Flow Rate	ℓ/h	2400			2400			2400		
Pump Energy Efficiency Index	EEL	≤ 0.20			≤ 0.20			≤ 0.20		
Domestic Hot Water Circuit										
Maximum DHW Heat Input	kW	31.15			35			38.8		
Minimum DHW Heat Input	kW	3.5			3.75			4.35		
Max. Domestic Hot Water flow rate (Δt: 30 °C)	ℓ/min.	14.8			16.80			19.00		
Min. Domestic Hot Water flow rate (for the DHW function activation)	ℓ/min.	1.5			1.5			1.5		
Maximum Water Pressure	bar	10			10			10		
Minimum Water Pressure	bar	0.5			0.5			0.5		
Temperature Adjustment Range	°C	35 - 60			35 - 60			35 - 60		
Electricity Circuit										
Electricity Supply	V AC-50 Hz	230 V +%10; -%15			230 V +%10; -%15			230 V +%10; -%15		
Electricity Consumption (Max./Min.)	Watt	95 / 55			104 / 60			115 / 65		
Protection Index	IP	IPX5D			IPX5D			IPX5D		
Exhaust Gas Circuit		G20	G25	G31	G20	G25	G31	G20	G25	G31
Flue Temperature (Qn)	°C									
(80/60 °C) Exhaust Gas Temperature (Min. / Max.)	°C	69.3 / 70.5	64.6 / 70.2	59.9 / 69.7	60.8 / 66.1	55.1 / 64.6	57.6 / 65.0	56.8 / 62.3	56.9 / 62.2	58.2 / 67.4
(50/30 °C) Exhaust Gas Temperature (Min. / Max.)	°C	48.5 / 50.5	47.7 / 49.4	47.0 / 50.5	44.5 / 44.5	44.0 / 44.1	43.4 / 44.9	46.8 / 44.2	46.7 / 44.5	48.7 / 48.9
Maximum Exhaust Gas Temperature [Maximum DHW mode]	°C	70			70			70		
NOx	Class	5			5			5		
Weighted Value of Nox (GCV)	mg/kWh	20	19	31	41	31	49	34	32	53
Flue Mass Flow Rate (60/80°C - Qn) Nominal/Minimum	g/s	10.32 / 1.6	10.78 / 1.62	9.91 / 1.18	13.23 / 1.72	13.13 / 1.73	12.71 / 1.62	14.76 / 1.88	15.54 / 1.97	14.03 / 1.81
Flue Mass Flow Rate (60/80°C - Qn) [Maximum DHW mode]	g/s	14.01	14.04	12.71	15.53	15.82	14.65	18.36	18.54	16.65
General										
Dimensions (H x W X D)	mm	725 x 420 x 288			725 x 420 x 288			725 x 420 x 288		
Sound Level	dB (A)	52			54			50		
Hydraulic Group Material		Brass			Brass			Brass		
Net Weight	kg	32.5			33.7			34.5		
Packed Device Weight	kg	34.7			35.9			36.7		
Type		C 13. C 33. C53. C63 C83			C 13. C 33. C53. C63 C83			C 13. C 33. C53. C63 C83		
Category		I2H (G20=20 mbar), I3P (G31=37 mbar)			I2H (G20=20 mbar), I3P (G31=37 mbar)			I2H (G20=20 mbar), I3P (G31=37 mbar)		

Table 4.30 Enerwa / Enerwa Plus Technical Table

### 4.38 Handing Over

After completing the installation and commissioning of the system the installer should hand over to the householder by the following actions:

1. Make the householder aware that the user instructions are located in the pocket in the drop down door and explain his/her responsibilities under the relevant national regulations.
2. Explain and demonstrate the lighting and shutting down procedures.
3. The operation of the boiler and the use and adjustment of all system controls should be fully explained to the householder, to ensure the greatest possible fuel economy consistent with the household requirements of both heating and hot water consumption.

Advise the User of the precautions necessary to prevent damage to the system and to the building, in the event of the system remaining inoperative during frosty conditions.

4. Explain the function and the use of the boiler heating and domestic hot water controls.

Explain that due to system variations and seasonal temperature fluctuations DHW flow rates/temperature rise will vary, requiring adjustment at the draw off tap. It is therefore necessary to draw the user's attention to the section in the Users Instructions titled "Control of Water Temperature" and the following statement: "Additionally, the temperature can be controlled by the user via the draw-off tap: The lower the rate the higher the temperature, and vice versa".

5. Explain the function of the boiler fault mode.
6. Explain and demonstrate the function of time and temperature controls, radiator valves etc., for the economic use of the system.
7. If a timer is fitted draw attention to the timer Users Instructions and hand them to the householder.
8. Loss of system water pressure.
9. Explain boiler restart procedure (refer to Section 2.27).
10. After installation and commissioning please complete the Commissioning Checklist before handover to the customer. For IE, it is necessary to complete a "Declaration of Conformity" to indicate compliance to I.S. 813:2002.

#### IMPORTANT

11. A comprehensive service should be carried out.

#### ANNUALLY

Stress the importance of regular servicing by a Gas Safe Registered Engineer. In IE servicing work must be carried out by a Registered Gas Installer (RGI).

12. Inform the householder of the guarantee form and the requirement to register it to receive the full benefit of the warranty.

### 4.39 Servicing Schedule

For the very latest copy of literature for specification & maintenance practices, visit our website [www.warmhaus.co.uk](http://www.warmhaus.co.uk), where you will be able to download the relevant information.

**WARNING** Always turn OFF the gas supply at the gas service cock, and switch OFF and disconnect the electricity supply to the appliance before servicing.

Combustion testing must be carried out by a competent person using

a combustion analyser conforming to BS7927.

To ensure the continued safe and efficient operation of the appliance it is recommended that it is checked at regular intervals and serviced as necessary. The frequency of servicing will depend upon the installation condition and usage but should be carried out at least annually.

It is the law that any service work must be carried out by a Gas Safe Registered Engineer. In IE service work must be carried out by a Registered Gas Installer (RGI).

#### INSPECTION

1. Light the boiler and carry out a pre-service check, noting any operational faults.
2. Check the flue terminal (and terminal guard if fitted) is undamaged and clear of any obstruction.
3. Check all water and gas joints for signs of leakage. Remake any suspect joints ensuring a gas tightness check is carried out if applicable and the water system is correctly refilled, vented and re-pressurized.

#### CLEANING PROCEDURE

**Note:** In order to carry out either servicing or replacement of components the boiler front panel must be removed. Refer to Section 4.38

1. Clean the main burner. Refer to Section 4.39
  2. Clean the heat exchanger & condensate trap/siphon. Refer to Section 4.40 & 4.41
  3. Check the main injector for blockage or damage. Refer to Section 4.44
  4. Check that the flue terminal is unobstructed and that the flue system is sealed correctly.
- ALSO IF THE DHW FLOW RATE IS IN QUESTION:
5. Check the DHW filter for blockage. Refer to Section 4.62
- The cleaning procedures are covered more fully in Section 4.42 to 4.44 and MUST be carried out in sequence.

#### IMPORTANT

6. After completing the servicing or exchange of components always test for gas tightness.
7. When work is complete the front panel MUST be correctly refitted, ensuring that a good seal is made.  
**DO NOT OPERATE** the boiler if the front panel is not fitted.
8. If, for any reason, the condensate trap/siphon has been removed ensure the trap is refilled with water before reassembling.
9. Check the gas consumption.
10. Check combustion by connecting the flue gas analyzer to the flue gas sampling point as shown in the diagram and measure CO & CO<sub>2</sub>. If the CO/CO<sub>2</sub> ratio is greater than 0.004 AND the integrity of the complete flue system and combustion circuit seals have been verified and the inlet gas pressure (and gas rate) have been verified, then contact Warmhaus.
11. Complete the service section in the Benchmark Commissioning Checklist.



**GENERAL**

**Please Note:** During routine servicing, and after any maintenance or change of part of the combustion circuit, the following must be checked:

- The integrity of the flue system and the flue seals.
- The integrity of the boiler combustion circuit and the relevant seals.
- The operational (working) gas inlet pressure at maximum rate.
- The gas rate.
- The combustion performance.

**COMPETENCE TO CARRY OUT THE CHECK OF COMBUSTION PERFORMANCE**

**Please Note:** BS 6798:2009 Specification for installation and maintenance of gas-fired boilers of rated input not exceeding 70 kW net advises that:

- The person carrying out a combustion measurement should have been assessed as competent in the use of a flue gas analyzer and the interpretation of the results.
- The flue gas analyzer used should be one meeting the requirements of BS7927 or BS-EN50379-3 and be calibrated in accordance with the analyzer manufacturers requirements, and
- Competence can be demonstrated by satisfactory completion of the CPAI ACS assessment, which covers the use of electronic portable combustion gas analysers in accordance with BS7967, Parts 1 to 4. PLEASE REFER TO PAGE 67-70 AND SECTION (4.7-4.7 A,-4.8,-4.9).

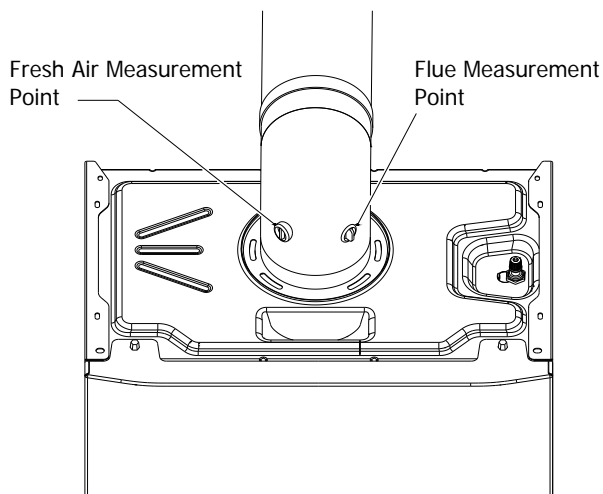

Figure 4.19

**4.40 Burner Removal And Cleaning**

1. Ensure the sump is fully drained.
2. Disconnect the electrical leads from the fan.
3. Pull the gas pipe clips and remove the gas pipe from the venturi.
4. Unplug the ignition lead from the electrode.
5. Remove the earth lead from the ignition electrode.
6. Loosen the 4 nuts that retain the burner.  
Take out the burner from the combustion chamber.

**IMPORTANT**

7. Brush off any deposits that may be on the ceramic with a SOFT brush.
8. Inspect the sealing gasket around the burner for any signs of damage. Replace as necessary.

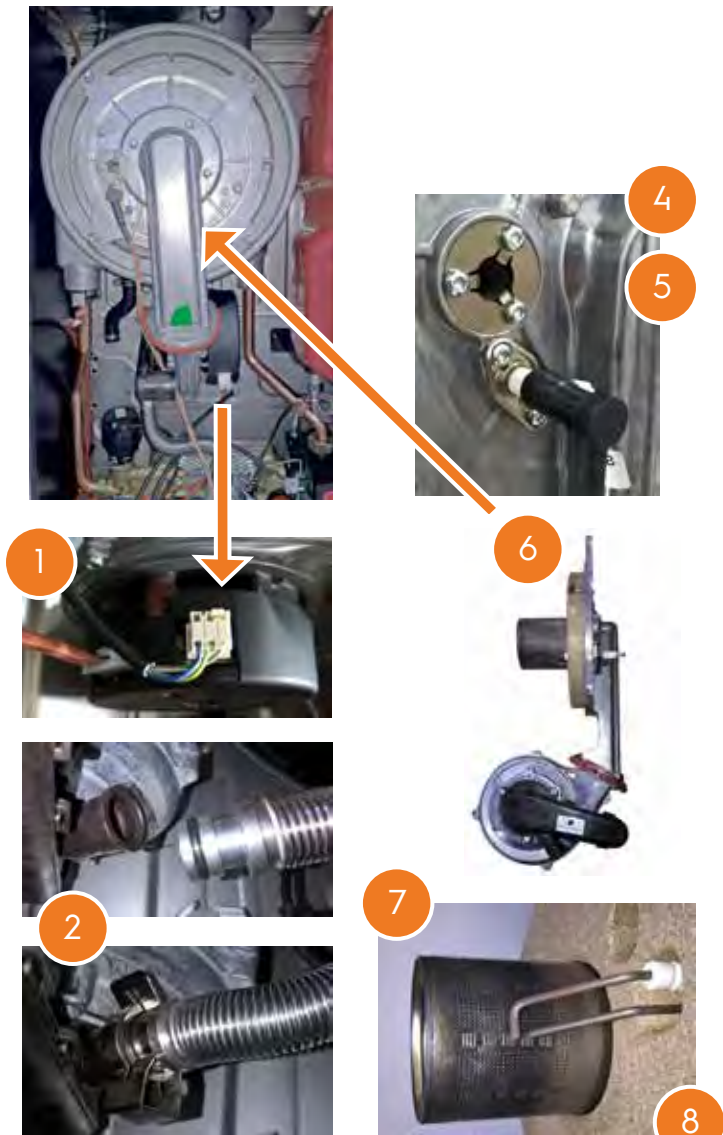

Figure 4.20

#### 4.41 Cleaning The Condensate Trap/Siphon

1. Refer to Section 4.43
2. Pull off the rubber pipe at the sump drain.
3. Disconnect the condensate drain pipe.
4. Loosen the two screws to disengage and lift to remove.
5. Clean siphon with water.
6. Re-assemble in reverse order.
7. When re-assembling ensure the trap is full of water.
8. Check operation of the boiler.

**Note:** Keep siphon upright when removing

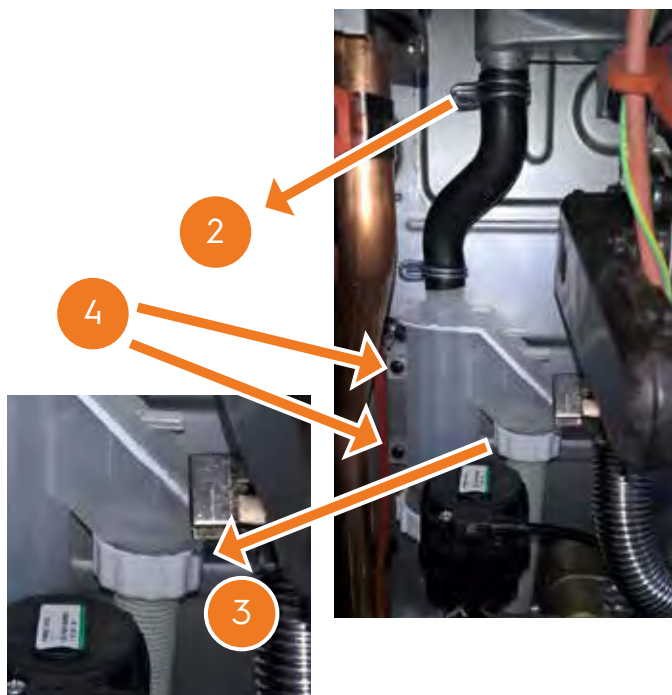

Figure 4.21

#### 4.42 Cleaning The Heat Exchanger

**Note:** Ensure the condensate trap/siphon is fully drained before cleaning. Refer to Section 4.56

1. Remove ignition and flame detection electrodes. Refer to Section 4.49
2. It is advisable to replace the sump cover prior to the water flush process.
3. Thoroughly flush the heat exchanger by pouring water into the top of the combustion chamber ensuring the full top area is covered.
4. Remove the sump cover and clean loose deposits from the sump.
5. Inspect the ignition and detection 3 electrodes. Ensure that they are clean and in good condition - replace if necessary.
6. Re-fit the ignition electrode ensuring that earth connector is fitted.
7. Check that the ignition and detection gaps are correct. Refer to Section 4.49.

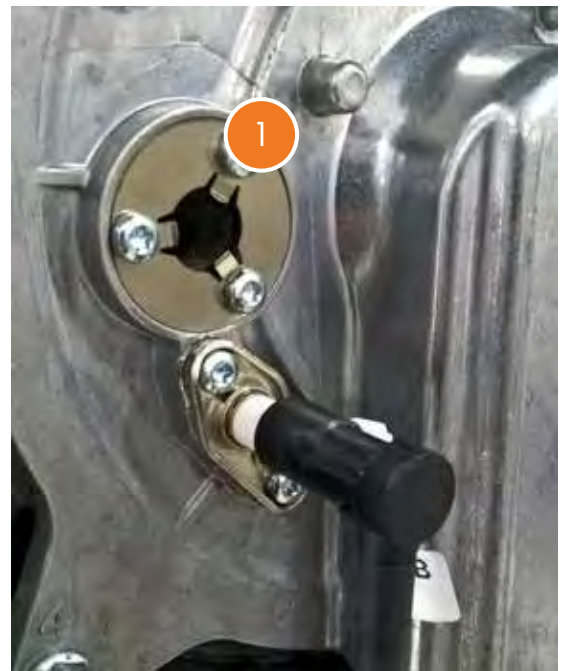

Figure 4.22

#### 4.43 Reassembly

Reassemble the boiler in the following order:

1. Ensure that the condensate trap/siphon is full of water.
2. Refit the burner ensuring the sealing gasket is correctly positioned and free from damage (tighten the 4 fixing screws in the sequence shown below).
3. Refit the fan / venturi assembly ensuring the retaining tabs are correctly positioned and the sealing gasket is correctly positioned and free from damage.
4. Reconnect the fan electrical leads.
5. Remove the sump cover and refit the lower flue manifold as shown.
6. Refit the sump cover.
7. Refit the boiler front panel.

**IMPORTANT:** Ensure that the boiler front panel is correctly fitted and that a good seal is made.

8. Swing the control box back into its working position and secure.
9. Turn on the gas supply at the gas service cock.
10. Reconnect the electrical supply.

#### 4.44 Replacement Of Components

1. Isolate the electricity supply.
  2. Turn off the gas supply.
  3. Remove the boiler front panel. Refer to Section 4.2.
  4. Release the retaining clip and swing the control box down into its servicing position.
- After replacing ANY component check operation of the boiler, including gas soundness, gas rate and combustion test.

**IMPORTANT:** When work is complete, the front panel must be correctly refitted - ensuring that a good seal is made.

#### Notes:

1. In order to assist fault finding, the control panel has a diagnostic display. The key to boiler fault conditions is shown in Frame 75.
2. In order to replace components in Section 4.57 - 4.66 it is necessary to drain the boiler. Refer to Section 4.2.

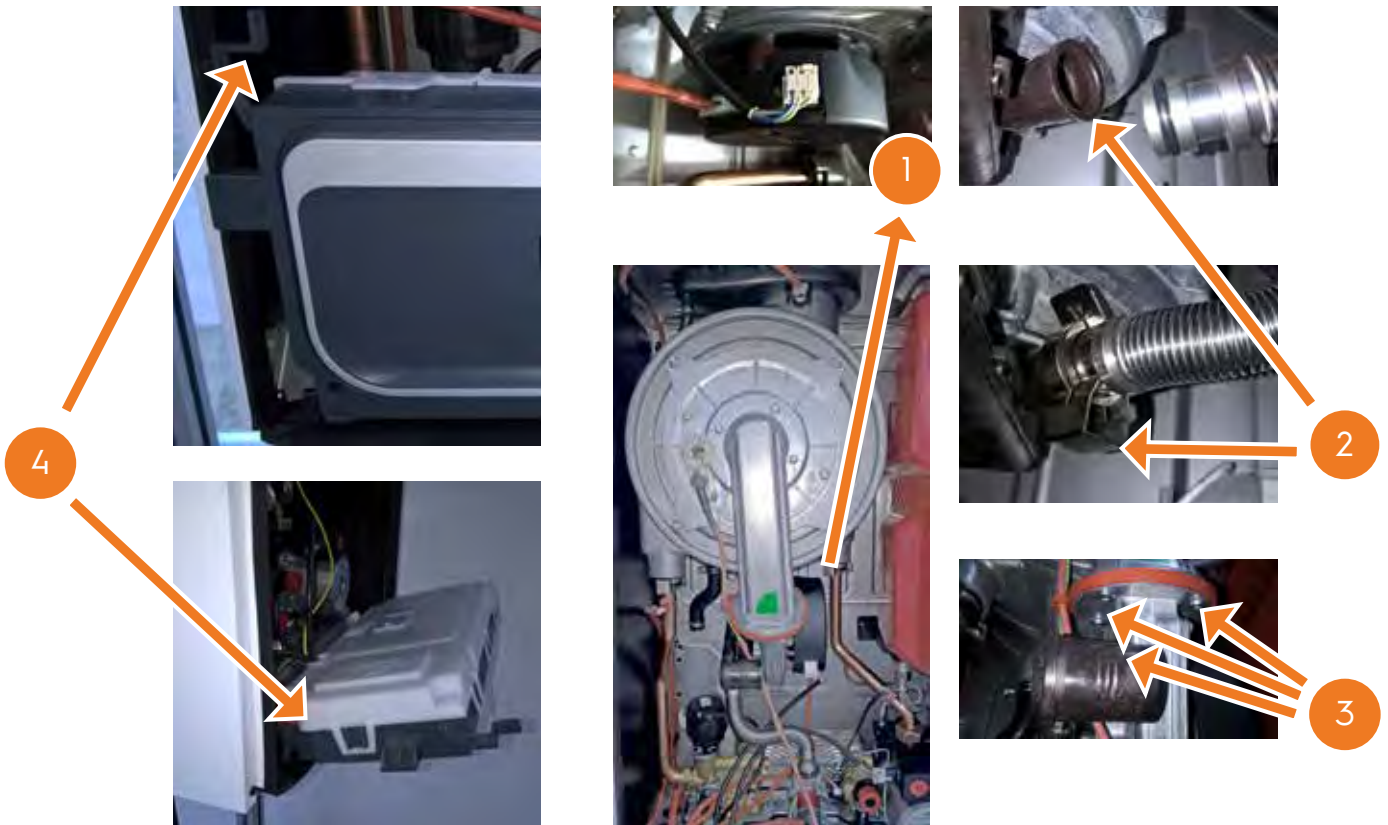

Figure 4.23

**THE BOILER MUST NOT BE OPERATED WITHOUT THE FRONT PANEL FITTED**

#### 4.45 Fan Replacement

1. Disconnect the electrical leads from the fan.
2. Pull the gas pipe clips and remove the gas pipe from the venturi.
3. Loosen the 4 bolts and remove the fan from the burner door.
4. Loosen the 3 bolts that retain the venturi to fan.
5. Lift and remove the fan and venturi assembly.
6. Transfer the venturi assembly to the new fan, replacing the 'o' ring if evidence of damage or deterioration is visible.
7. Fit the new fan / venturi assembly ensuring the retaining tabs are correctly positioned and the fan outlet sealing gasket is correctly positioned and free from damage.
8. Reassemble the boiler in reverse order. Make sure gas pipe correctly mounted to the venturi.
9. Check the operation of the boiler.
10. Make AUTO CALIBRATION (Refer to page 76, section 4.14, page 77 section 4.15)

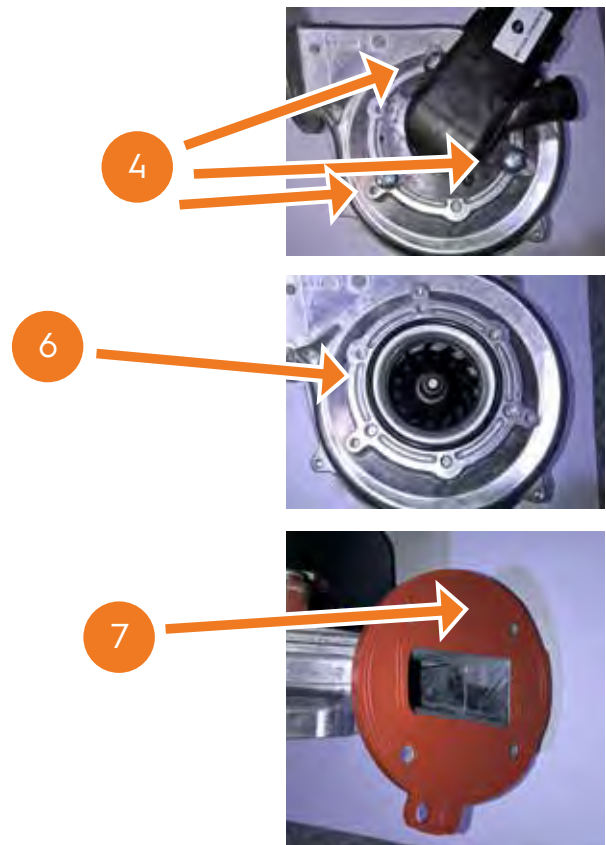

Figure 4.24

## 4.46 Burner Injector Replacement

1. Disconnect the electrical leads from the fan.
2. Pull the gas pipe clips and remove the gas pipe from the venturi.
3. Undo the union nut on the outlet of the gas control valve. Remove the gas pipe.
4. Replace the old injector with the new one.
5. Reassemble in reverse order, ensuring that the new gas seal supplied is located correctly in the injector housing.
6. Check operation of the boiler.
7. Make Auto Calibration page 76, sec. 4.14 or page 77, sec. 4.15.

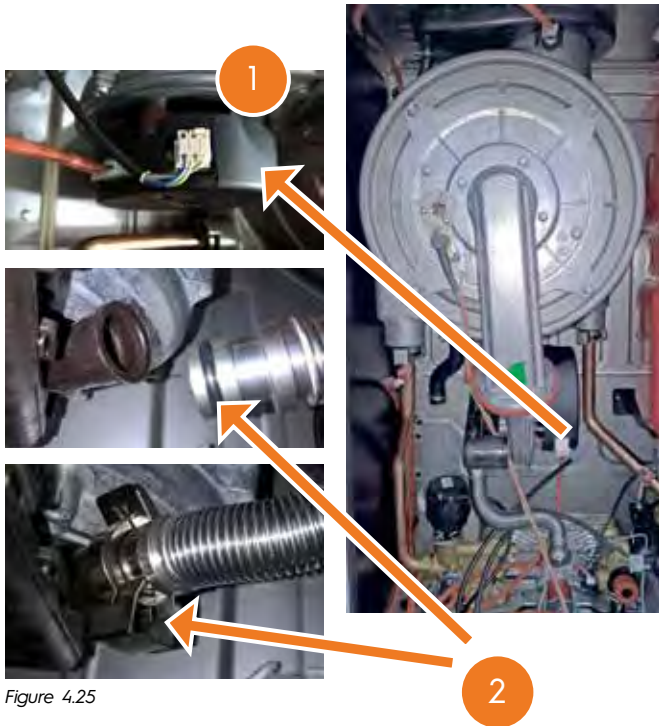

Figure 4.25

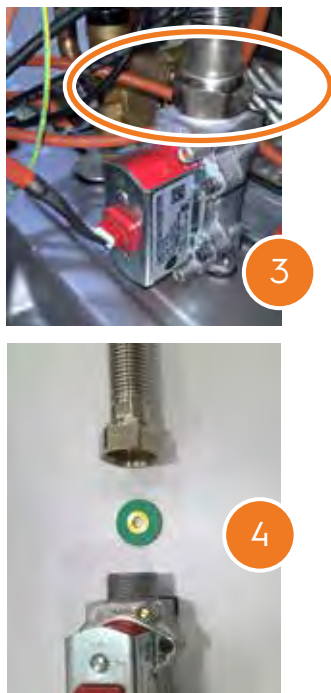

Figure 4.26

## 4.47 Burner Replacement

1. Ensure the sump is fully drained.
2. Disconnect the electrical leads from the fan.
3. Pull the gas pipe clips and remove the gas pipe from the venturi.
4. Unplug the ignition lead from the electrode.
5. Remove the earth lead from the ignition electrode.
6. Loosen the 4 nuts that retain the burner. Take out the burner from the combustion chamber.
7. Fit the new burner, replacing any damaged or deteriorating sealing gasket.
8. Reassemble in reverse order. Refer to Section 4.42
9. Tighten the 4 nuts cross way. Make sure correctly sealed.
10. Check the operation of the boiler. Refer to Frame 36
11. Make sure gas pipe correctly mounted to the venturi and no gas leakage.
12. Make AUTO Calibration page 76 & sec. 4.14 or page 77 & sec. 4.15.

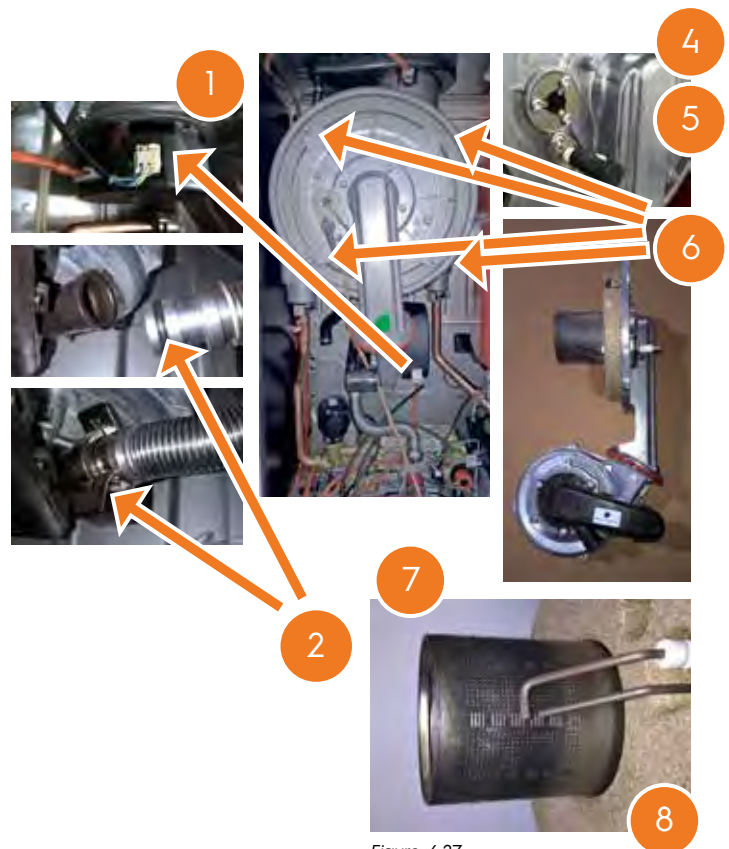

Figure 4.27

#### 4.48 Flow And Return Thermistors Renewal

1. Refer to Section 4.43.
2. Unclip the return thermistor from the return pipe and withdraw it from the boiler.
3. Unclip the flow thermistor from the return pipe
4. Disconnect the electrical lead from the thermistor.
5. Reconnect the electrical lead to the new thermistor and reassemble in reverse order, ensuring that the thermistor is securely fitted to the pipe on the NTC locator tabs as shown.



Figure 4.28

3- Flow Temperature Sensor

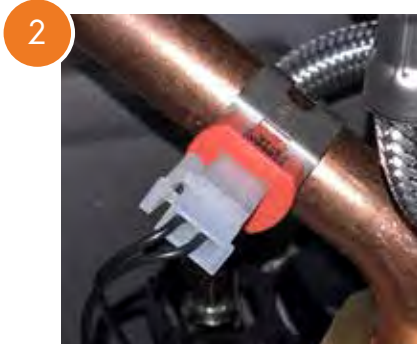

3- Return Temperature Sensor

Figure 4.29

#### 4.49 Flue Thermistor Replacement

1. Refer to Section 4.43
2. Disconnect the electrical lead from the flue thermistor. Rotate thermistor clockwise and pull the sensor to remove.
3. Reconnect the electrical lead to the new thermistor and reassemble in reverse order, ensuring that the NTC is securely fitted.

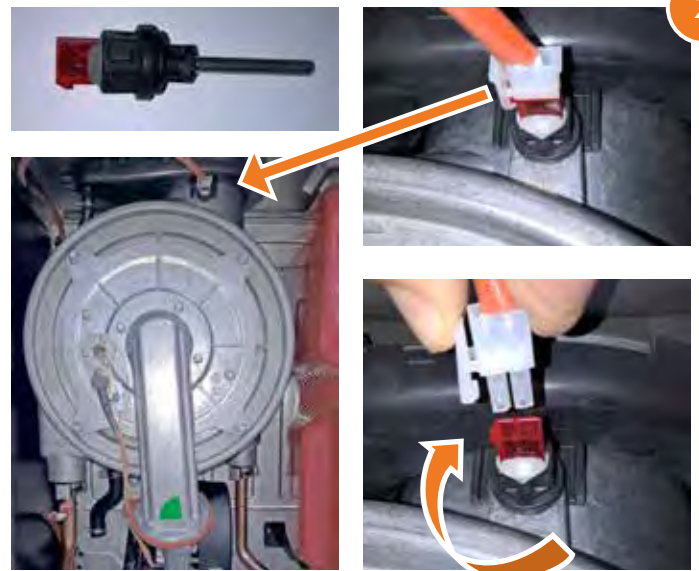
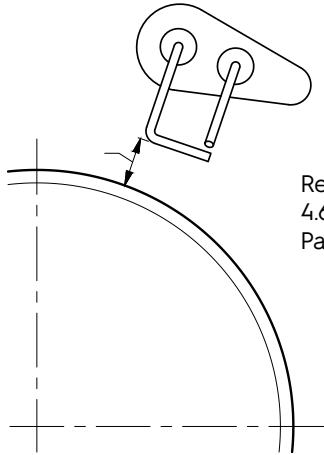

Figure 4.30

## 4.50 Ignition Electrode Replacement

1. Refer to Section 4.43.
2. Remove the burner. Refer to Section 4.46.
3. Unplug the ignition lead from the electrode.
4. Remove the earth lead from the ignition electrode.
5. Remove the 2 screws holding the ignition electrode to the combustion chamber.
6. Remove the electrode.
7. Fit the new ignition electrode, using the new gasket supplied. Check dimensions as shown.
8. Calibrate electrode according to section 4.69, page 117.
9. Reassemble in reverse order.
10. Check the operation of the boiler. Refer to Section 4.43.
11. Make AUTO Calibration page 76, sec .4.14 or page 77, sec.4.15



Refer to section  
4.69 & 4.70  
Page 117.

Figure 4.31

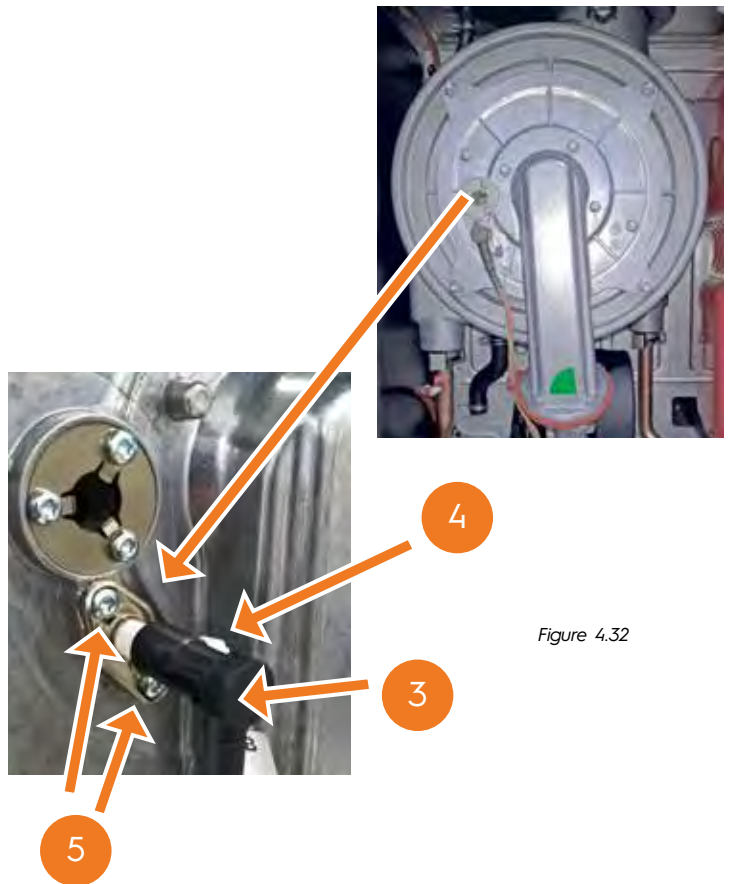

Figure 4.32

## 4.51 Gas Control Valve Replacement

1. Refer to Section 4.43
2. Unplug the electrical plug connection from the gas control valve.
3. Undo the union nut on the outlet of the gas control valve.
4. Loosen the 2 screws at the bottom retaining the valve to the boiler body and withdraw the valve forwards.
6. Fit the new gas control valve ensuring the injector and sealing washers are in place and reconnect gas and electrical connections.
7. Check operation of the boiler.
8. Make Auto Calibration page 76, sec. 4.14 or page 77, sec. 4.15

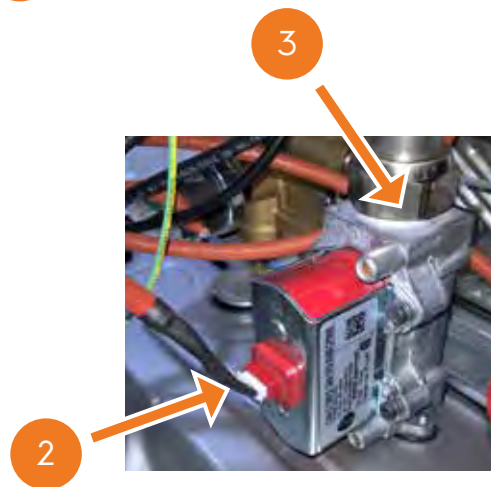
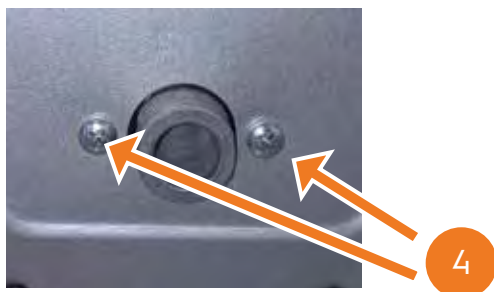

Figure 4.33

### 4.52 Diverter Valve Actuator Replacement

1. Refer to Section 4.43
2. Remove the electrical plug.
3. Using a suitable tool pull out the retaining clip and lift the diverter head from the brass body.
4. Fit new actuator head and reassemble in reverse order.
6. Check operation of the boiler.

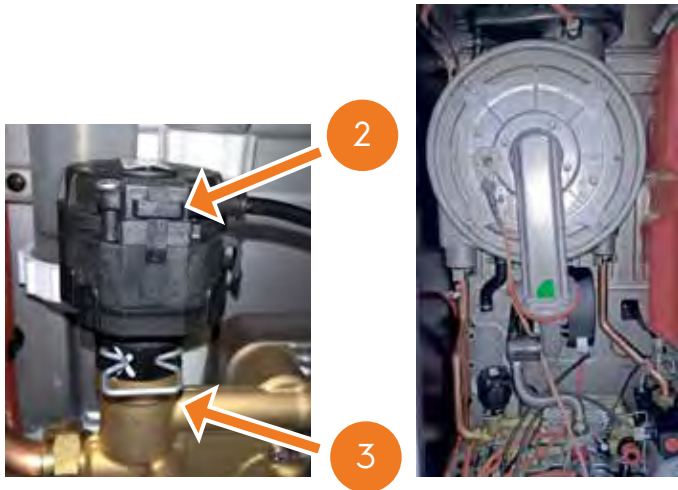

Figure 4.34

### 4.53 Condensate Trap/Siphon Replacement

1. Refer to Section 4.43
  2. Pull off the rubber pipe at the sump drain.
  3. Disconnect the condensate drain pipe.
  4. Loosen the two screws to disengage and lift to remove.
- Note:** Keep siphon upright when removing
5. Clean siphon with water.
  6. Re-assemble in reverse order.
  7. When re-assembling ensure the trap is full of water.
  8. Check operation of the boiler.

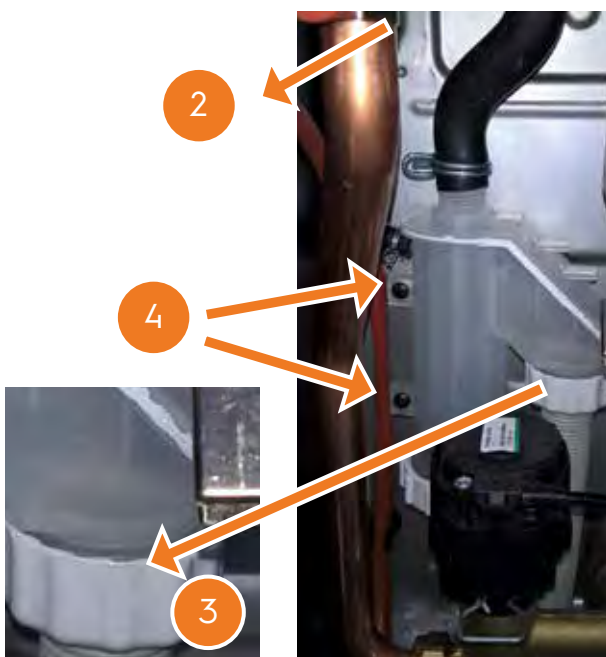

Figure 4.35

### 4.54 Main Pcb Replacement

**Note:** Fit the earth strap provided with the PCB to your wrist and secure to a suitable earth on the boiler chassis.

1. Refer to Section 4.43.
  2. Note the control knob positions.
  3. Carefully lift the 8 retaining clips and remove control box cover.
  4. Remove the 2 screws retaining the PCB.
  5. Spring out the two side retaining clips and pull the PCB upwards to clear the 4 corner retaining posts.
  6. Unplug all lead connections to the PCB including the ribbon cable (to facilitate ribbon cable removal, ease side clips apart and pull upwards), also where applicable, push the small plastic clip with an electrical screwdriver to facilitate plug removal.
  7. Take the new Primary PCB and attach the appropriate Boiler Chip Card (PCB).
- Note:** Ensure the correct orientation of PCB by placing
8. Re-connect all plug connections.
  9. Reassemble in reverse order.
  10. Turn power back on to the boiler, after a few moments the display will start alternating between "c" and "0". Turn the reset knob fully clockwise and when the display shows " - " turn the knob fully anti-clockwise IMMEDIATELY. Finally move the knob into the required position (Standby, Summer or Winter).
  11. Check operation of the boiler.
  12. Make Auto Calibration page 76, sec. 4.14 or page 77, sec. 4.15



Figure 4.36

### 4.55 User Control PCB Replacement (Plus) Models

1. Refer to Section 4.43
2. Remove the main PCB, refer to Section 4.53
3. Remove the 4 screws retaining the PCB of display posts.
4. Fit the new PCB.
5. Reassemble in reverse order.
6. Check operation of the boiler.

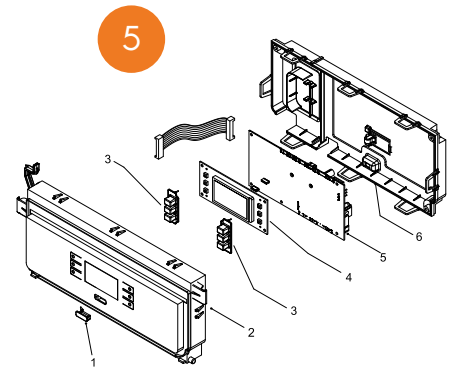
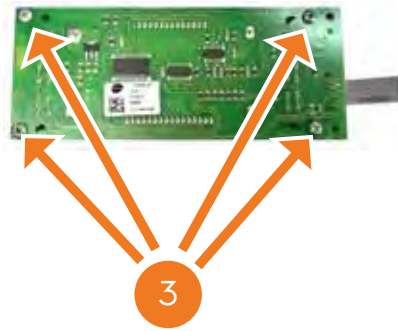

Figure 4.37

### 4.56 DHW Flow Turbine Sensor Replacement

1. Refer to Frame Section 4.43
2. Lift off the flow turbine sensor plastic retaining clip.
3. Unplug the electrical connection and transfer to new turbine sensor.
4. Reassemble in reverse order.
5. Check operation of the boiler.

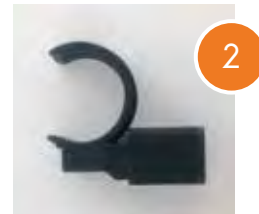

Figure 4.38

### 4.57 Draining The Boiler

#### Central heating circuit

1. Refer to Section 4.43
2. Close all the CH water isolating valves on the boiler inlet.
3. To drain the primary heat exchanger circuit: Open the drain valve and attach a length of hose to the CH drain point.
4. After replacing any component on the boiler, remove the hose, close the drain valve and open all system isolating valves (re-pressurise as appropriate by re-connecting the filling loop) before proceeding to check operation of the boiler.
5. Disconnect filling loop.
6. Check operation of the boiler.

#### Domestic hot water circuit

1. Refer to Section 4.43
2. Close all the DHW water isolating valves on the boiler inlet.
3. To drain the domestic hot water circuit: As there is no direct drain for the domestic hot water circuit, depending on the location of the boiler, opening the lowest hot water tap may drain this circuit. However it must be noted that some residual water will be experienced during replacement of components.
4. After replacing any component on the boiler, close tap, close the drain valve and open all system isolating valves (repressurise as appropriate by re-connecting the filling loop) before proceeding to check operation of the boiler.
5. Disconnect filling loop.
6. Check operation of the boiler.



Figure 4.39



#### 4.58 Pressure Gauge Renewal

1. Refer to Section 4.43
2. Drain the heating system. Refer to Section 4.56
3. Unscrew the pressure gauge.
4. Remove the clips that retain the pressure gauge and discard
5. Fit new pressure gauge, using suitable gasket.
6. Refill the boiler.
7. Check operation of the boiler.

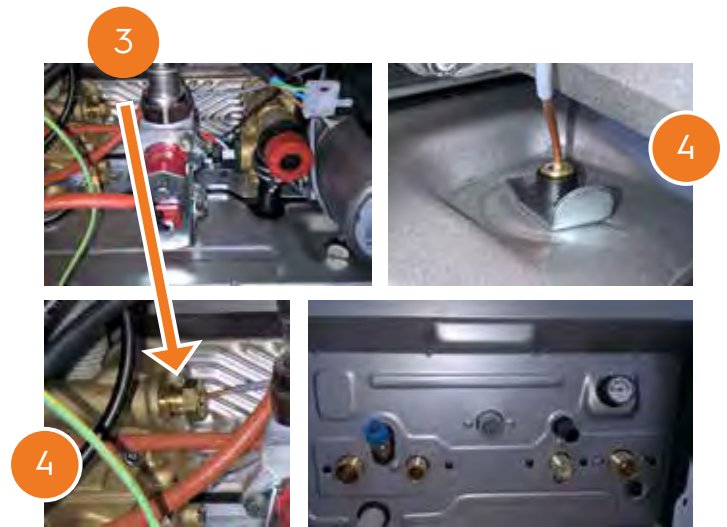

Figure 4.40

#### 4.59 Safety Relief Valve Renewal

1. Refer to Section 4.43
2. Drain the boiler. Refer to Section 4.56
3. Release the setscrew securing the safety valve.
4. Undo the safety valve union connection.
5. Pull safety valve from boiler.
6. Fit the new safety valve and reassemble in reverse order ensuring the new 'o' ring is fitted to the top of the return pipe.
7. Refill boiler. Check operation of boiler.

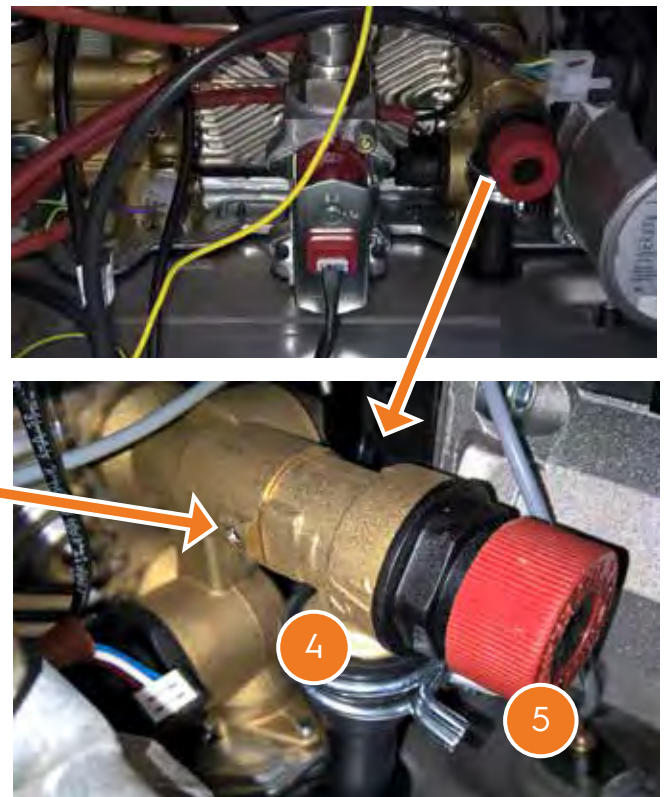

Figure 4.41



#### 4.60 Pump Automatic Air Vent Replacement

1. Refer to Section 4.43
2. Drain the boiler. Refer to Section 4.56
3. The automatic air vent head is retained in the pump body with a bayonet connection. The air vent head and float assembly is removed by turning the head anticlockwise (viewed from above) and pulling upwards.
4. Reassembly is the reverse of the above. Ensure the air vent head 'o' ring seal is in place when refitting and the new 'o' ring is fitted to the return pipe top connection.
5. Ensure the air vent cap is loose.
6. Refill the boiler. Check for leaks around the new air vent joint.
7. Check the operation of the boiler.

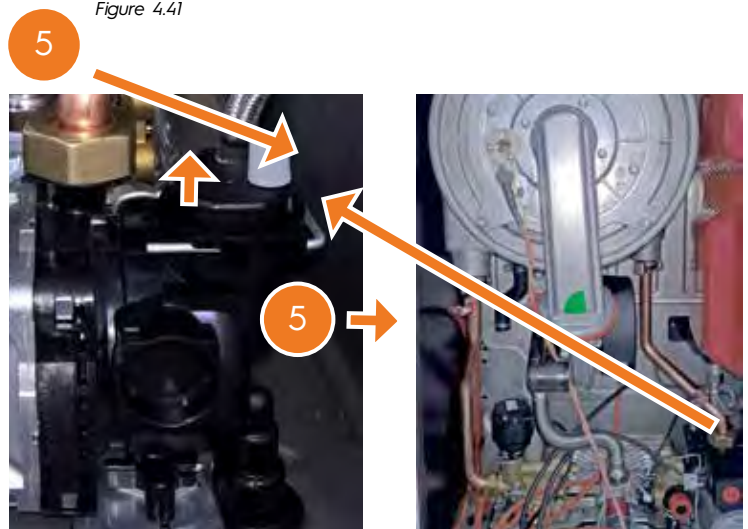

Figure 4.42

#### 4.61 DHW Flow Turbine Cartridge Replacement

1. Refer to Section 4.43
2. Drain the boiler. Refer to Section 4.56
4. Remove the DHW flow turbine sensor. Refer to Section 4.55
5. Unscrew the connection to access the internal part.
6. Fit the new turbine cartridge.
7. Refit the turbine flow sensor
8. Reassemble in reverse order.
9. Refill the boiler.
10. Check operation of the boiler.



Figure 4.43



Figure 4.44

#### 4.62 Diverter Valve Internal Cartridge Replacement

##### FRONT CARTRIDGE REPLACEMENT

1. Refer to Section 4.43
2. Drain the boiler. Refer to Section 4.61
3. Remove the diverter valve head. Refer to Section 4.51
4. Unscrew the top connection to access the internal cartridge.
5. Fit the new valve mechanism ensuring the correct fit of the pin.
6. Reassemble in reverse order.
7. Refill the boiler.
8. Check operation of the boiler.

##### REAR CARTRIDGE REPLACEMENT

1. Refer to Section 4.43
2. Drain the boiler. Refer to Section 4.56
3. Remove the diverter valve head. Refer to Section 4.51
4. Remove the flow pipe.
5. Disconnect the CH flow pipe and DHW outlet pipe union connections underneath the boiler. Refer to Section 4.56
6. Remove the plate heat exchanger LH fixing screw. Refer to Section 4.62.
7. Remove the screw retaining the brass block to the bottom of the boiler casing and lift the brass block clear of the boiler.
8. Unscrew the rear cartridge connection.
9. Fit the new valve mechanism ensuring the correct fit of the pin.
10. Reassemble in reverse order.
11. Refill the boiler.
12. Check operation of the boiler.



Figure 4.45

### 4.63 DHW Plate Heat Exchanger Replacement

1. Refer to Section 4.43
2. Drain the boiler. Refer to Section 4.56
3. Remove condensate trap/siphon. Refer to Section 4.56
4. Remove the safety relief valve. Refer to Section 4.58
5. Remove the diverter valve actuator. Refer to Section 4.51
6. Remove the 2 allen screws securing the plate heat exchanger to the brass housings.

7. Manoeuvre the plate heat exchanger out of the top LH or centre of the controls area.
8. Fit the new plate heat exchanger, using the new o-rings supplied.  
**Note:** The mounting pins are offset so the correct position can be defined from the location of the holes on the brass mounting.
9. Reassemble in reverse order.
10. Refill the boiler.
11. Check operation of the boiler.

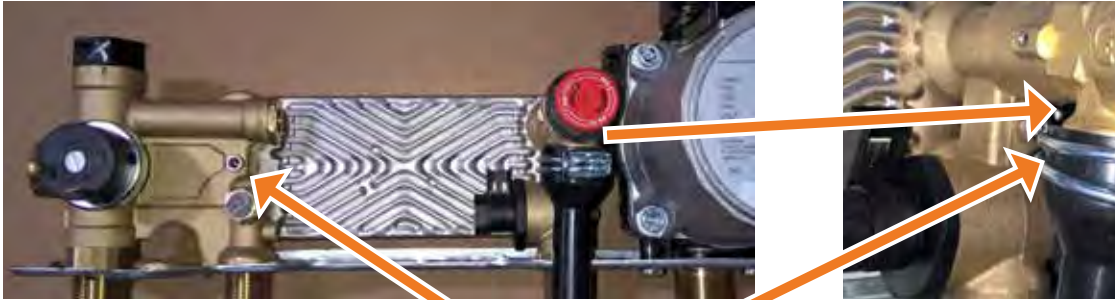
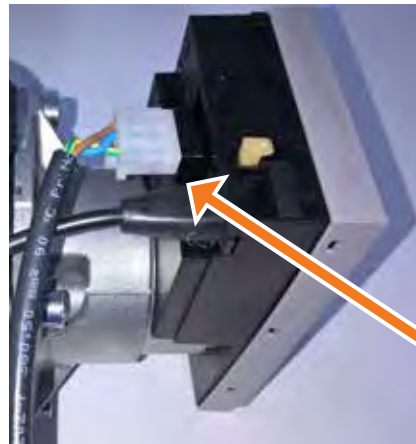

Figure 4.46

5

### 4.64 Pump Head Replacement

1. Refer to Section 4.43
2. Drain the boiler. Refer to Section 4.56
3. Disconnect the electrical plug from the pump.
4. Remove the 4 Allen screws retaining the pump head.
5. Remove the pump head.
6. Fit the new pump head.
7. Reassemble in reverse order.
8. Refill the boiler.
9. Check operation of the boiler.



3



4

Figure 4.47

#### 4.65 CH Water Pressure Sensor Replacement

1. Refer to Section 4.43
2. Drain the boiler. Refer to Section 4.56
4. Using a suitable tool unscrew the water pressure sensor.
5. Pull the pressure sensor upwards to remove.
6. Unplug the electrical connection and transfer to the new pressure sensor.
7. Push the new pressure sensor in to the brass block and fix it. Ensure that the gasket is placed.
8. Reassemble in reverse order.
9. Refill the boiler. Refer to Frame 22
10. Check Operation of the boiler. Refer to Frame 36

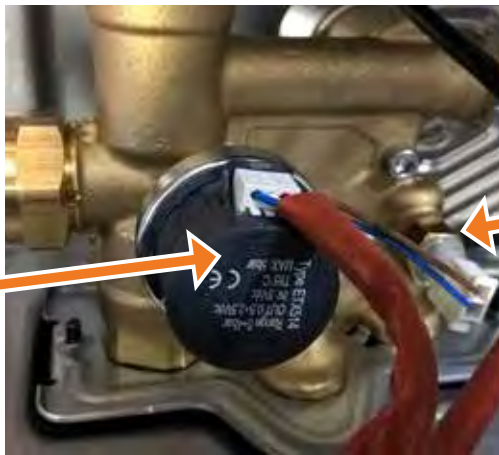

Figure 4.48

#### 4.66 DHW Filter Cleaning / Replacement

1. Refer to Section 4.43
2. Isolate the mains cold water supply to the boiler.
3. Drain the boiler DHW circuit. Refer to Section 4.56
4. Remove the DHW flow turbine cartridge. Refer to Section 4.60
5. Unscrew the flow regulator housing.
6. Remove the filter.
7. Clean or replace filter as necessary.
8. Reassemble in reverse order.
9. Refill the boiler. Refer to Frame 22
10. Check Operation of the boiler. Refer to Frame 36



Figure 4.49

### 4.67 Heat Engine Renewal

Refer also to Frame 6 - 'Boiler Exploded View'

**IMPORTANT:** Before starting the removal procedure, protect the gas and electrical controls with a waterproof sheet or plastic bag.

1. Refer to Section 4.43
2. Drain the boiler. Refer to Section 4.56
3. Remove the fan / venturi assembly and place on one side. Refer to Section 4.44
4. Remove the burner and place on one side. Refer to Section 4.46
5. Remove the ignition electrode. Refer to Section 4.49
6. Remove the ground connector.
7. Disconnect flue thermostat.
8. Remove the gas valve. Refer to Section 4.50
9. Remove the expansion vessel. Refer to Section 4.67
10. Undo the inlet pipe union nut and remove the retaining spring clip and remove pipe.
11. Undo the flow pipe union nut and remove pipe.
12. Remove the condensate rubber pipe. Refer to Section 4.52
13. Remove the two heat exchanger fixing screws.
14. Remove the Heat exchanger.
15. Reassemble in reverse order, ensuring the heat exchanger LH retaining bracket is correctly positioned. Replace any new 'o' rings supplied with new heat exchanger and replacing gaskets or seals if any sign of damage is evident. When replacing the spring clips located on both the flow and return pipe connections, ensure clip is oriented to correctly match connecting pipe diameters.
16. Ensure the trap/siphon is filled with water. Refer to Section 4.52.
17. Refill the boiler.
18. Check operation of the boiler.
19. Make AUTO Calibration page 76, section 4.14 or page 77 section 4.15

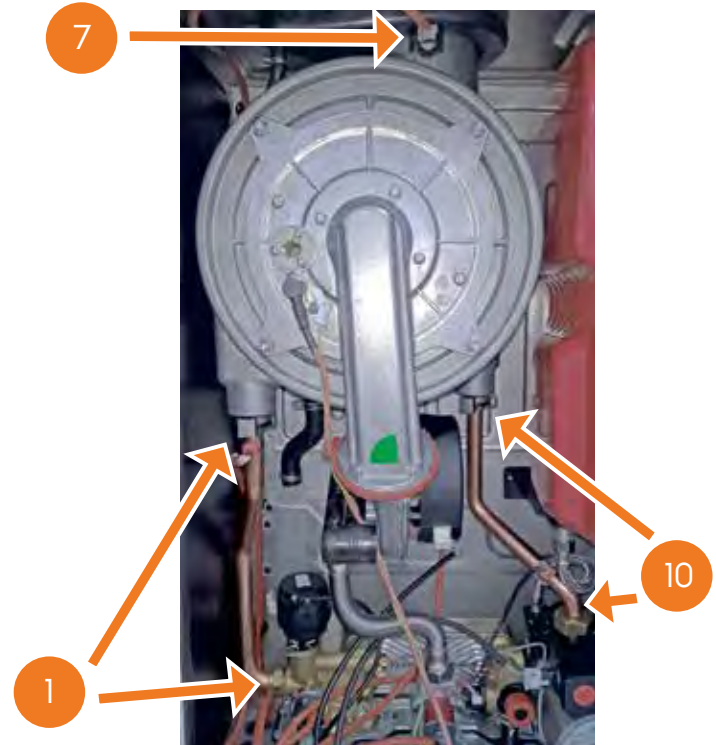

Figure 4.50

### 4.68 Expansion Vessel Recharging & Replacement

#### RECHARGING

1. Refer to Section 4.43
2. Remove the charge point cover.
3. Recharge the tank pressure to 0.75 bar.
4. Re-assemble in reverse order
5. Check operation of the boiler.

#### REPLACEMENT

6. Refer to Section 4.43
7. Drain the boiler CH circuit. Refer to Section 4.56
8. Unscrew the union nut on the vessel water connection pipe.
9. Support the expansion vessel and unscrew the 2 screws from the securing clamp, located on the top of the boiler, and remove.  
**Note:** The position of the bracket on the vessel.
10. Remove the expansion vessel.
11. Fit the new expansion vessel.
12. Reassemble in reverse order.
13. Refill the boiler.
14. Check operation of the boiler.



Figure 4.51

### 4.69 Boiler Sealing Panel Replacement Seal Replacement

1. Refer to Section 4.43
2. Remove the old seal from the casing and thoroughly clean the casing surfaces.
3. Fit the new seal, ensuring the bottom joint provides an air tight seal.
5. Reassemble in reverse order.
6. Check operation of the boiler.

**NOTE:** Ensure that the boiler front panel is correctly sealed, compressing the seal to make an airtight joint.

### 4.70 Electrode Positioning For 24 kW

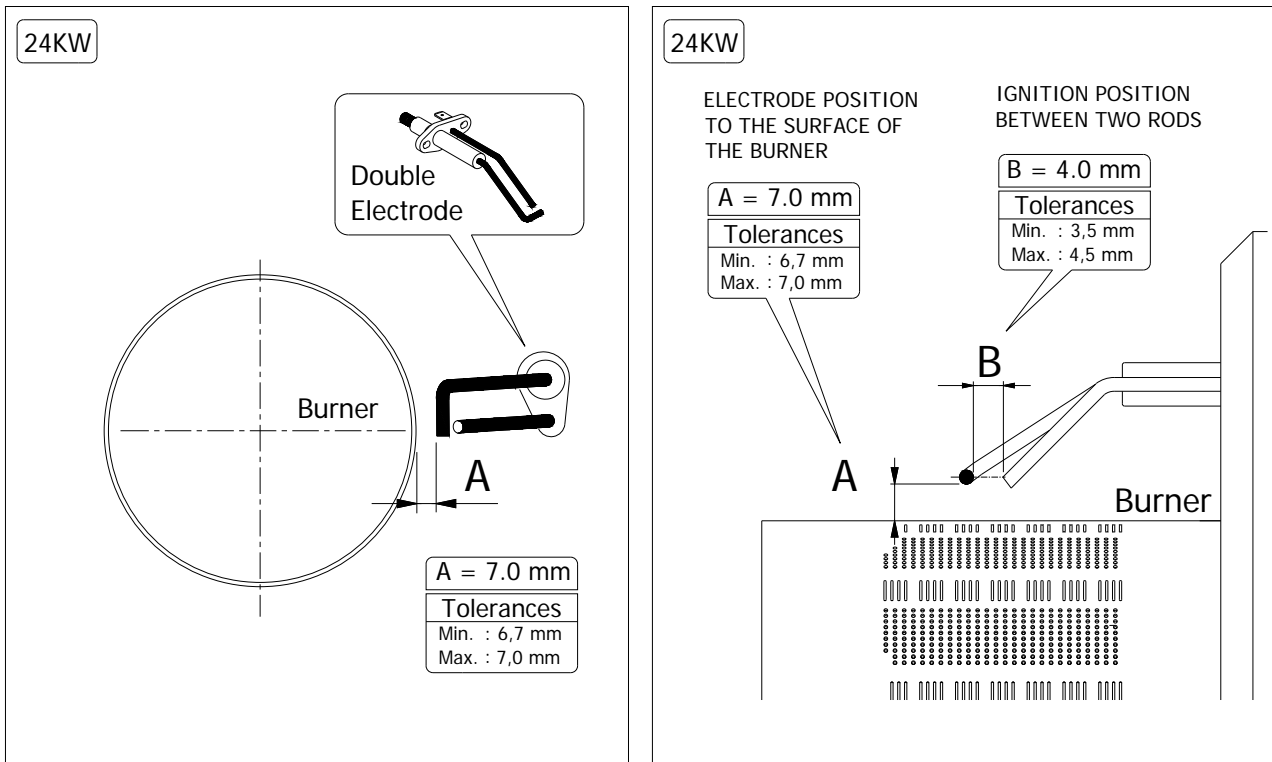

The boilers Valid for;

- Priwa 24 / Priwa Plus 24
- Enerwa 24 - 2530 C
- Enerwa Plus 24 - 2530 C

**Attention 1:** This dimensions are valid ONLY for 24 KW Premix boilers.

**Attention 2:** IF electrode changed OR re-calibrated; THEN performing Au-TO or MA-NU calibration mandatory.

**Attention 3:** Electrode must be replaced with ONLY Original Warmhaus Part, do not ever try other similar parts to be used on.

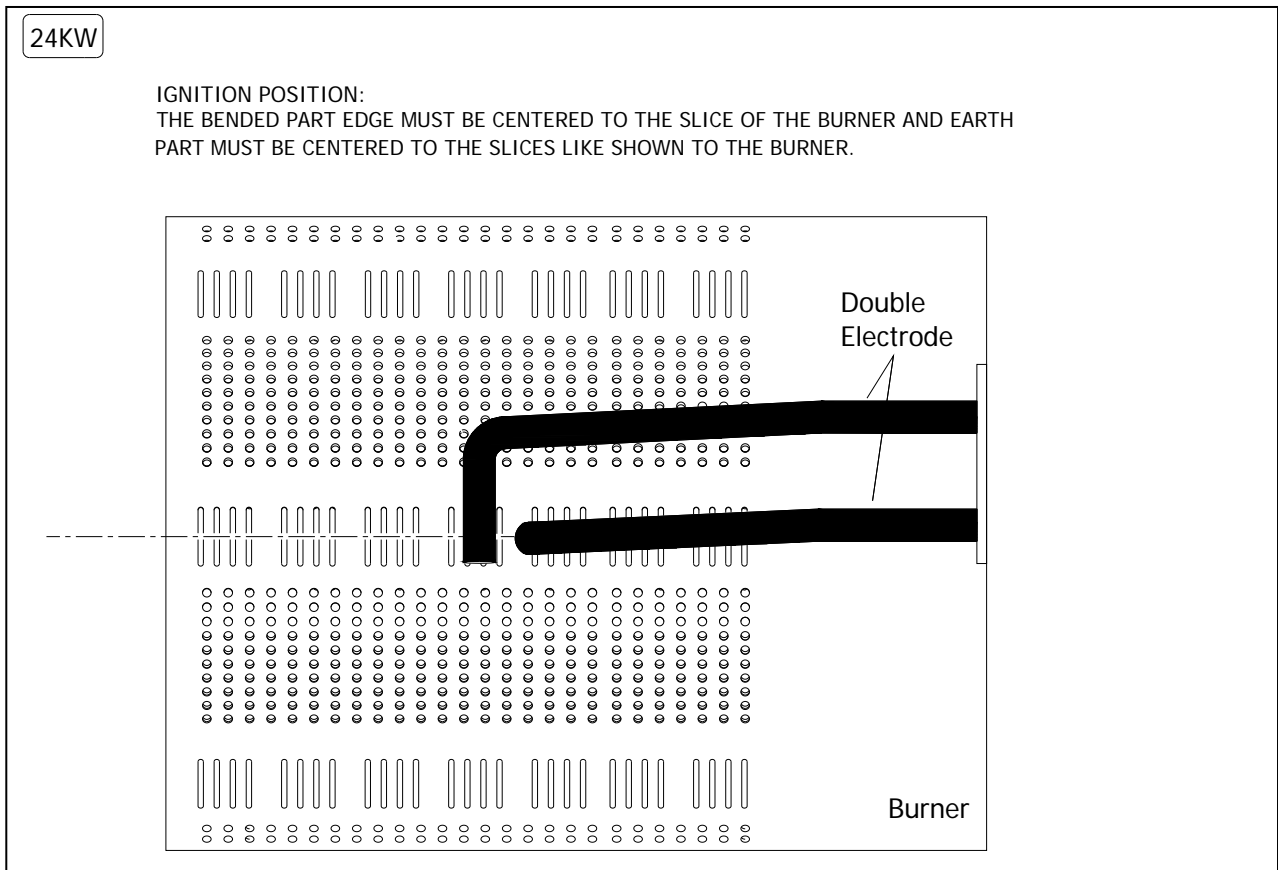
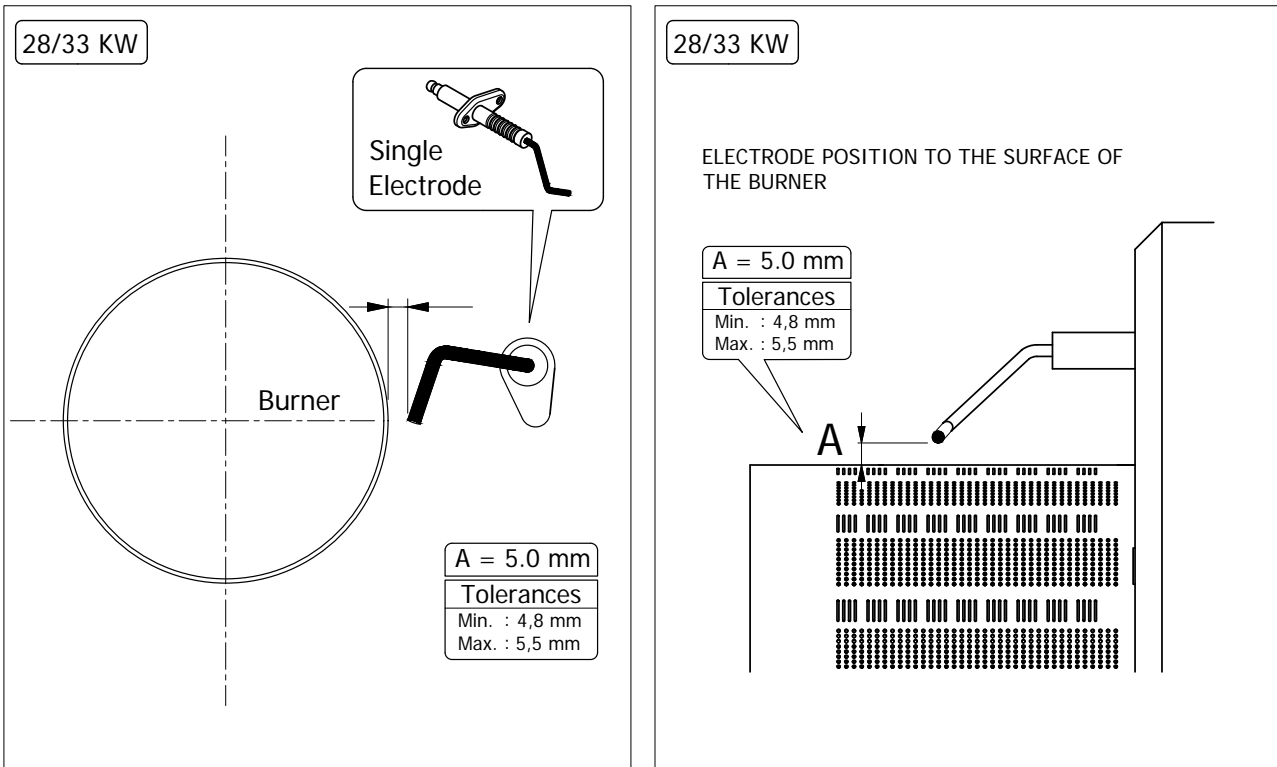

Figure 4.52 24 kW Electrode Positioning

#### 4.71 Electrode Positioning For 28 kW And 33 kW



The boilers Valid for;

- Priwa 28 / Priwa Plus 28
- Enerwa 28 / Enerwa Plus 28 - 3035 C
- Priwa 33 / Priwa Plus 33
- Enerwa 33 / Enerwa Plus 33 - 3540 C

**Attention 1:** These dimensions are valid ONLY for 28 KW OR 33 KW Premix boilers.

**Attention 2:** IF electrode changed OR re-calibrated; THEN performing Au-TO or MA-NU calibration mandatory.

**Attention 3:** Electrode must be replaced with ONLY Original Warmhaus Part, do not ever try other similar parts to be used on.

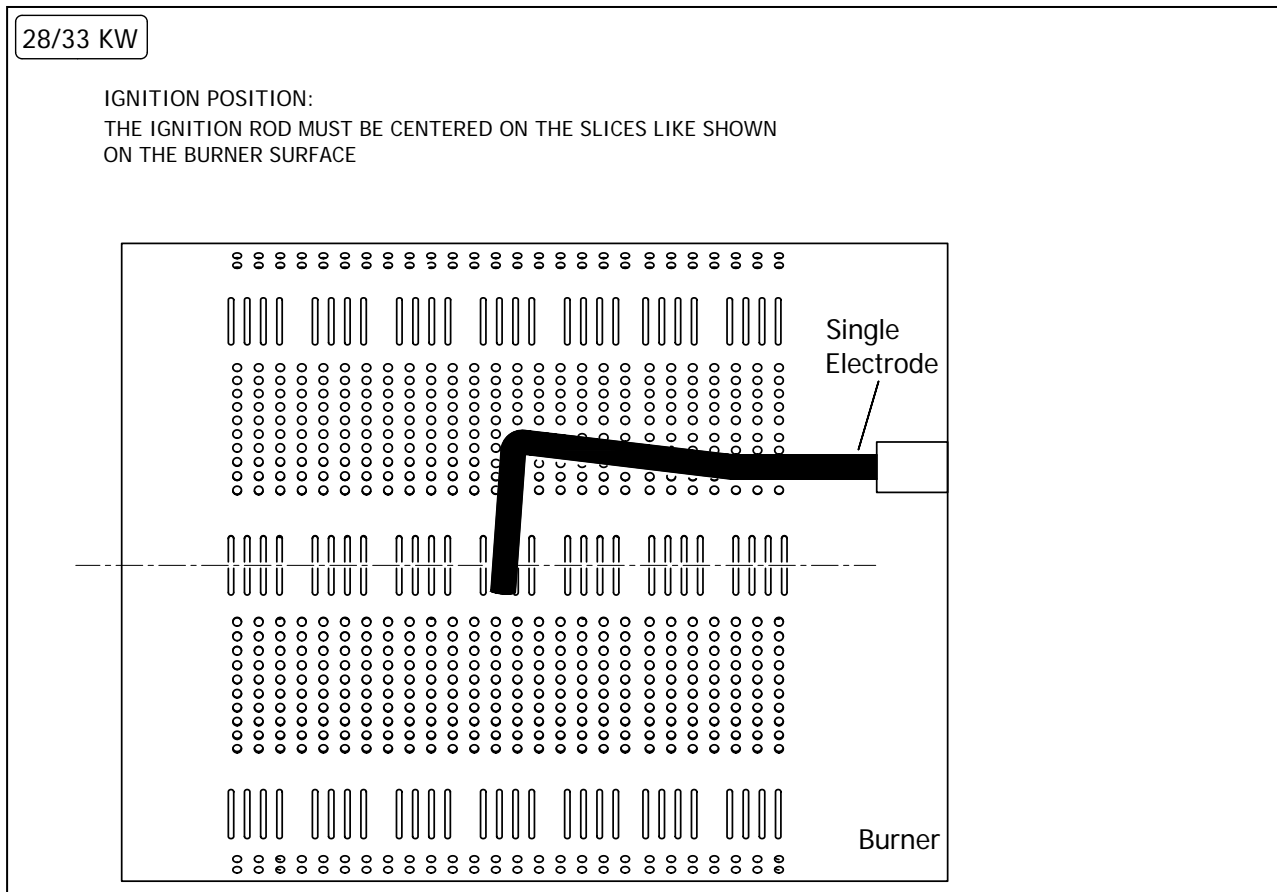

Figure 4.53 28 kW and 33 kW Electrode Positioning

# Code Of Practice

For the installation, commissioning and servicing of domestic heating and hot water products

Benchmark places responsibilities on both manufacturers and installers.\* The purpose is to ensure that customers\*\* are provided with the correct equipment for their needs, that it is installed, commissioned and serviced in accordance with the manufacturer's instructions by competent persons and that it meets the requirements of the appropriate Building Regulations. Installers are required to carry out work in accordance with the following:

## Standards of Work

- Be competent and qualified to undertake the work required.
- Install, commission, service and use products in accordance with the manufacturer's instructions provided.
- Ensure that where there is responsibility for design work, the installation is correctly sized and fit for purpose.
- Meet the requirements of the appropriate Building Regulations. Where this involves notifiable work be a member of a Competent Persons Scheme or confirm that the customer has notified Local Authority Building Control (LABC), prior to work commencing.
- Complete all relevant sections of the Benchmark Checklist/Service Record when carrying out commissioning or servicing of a product or system.
- Ensure that the product or system is left in a safe condition and, whenever possible, in good working order.
- Highlight to the customer any remedial or improvement work identified during the course of commissioning or servicing work.
- Refer to the manufacturer's helpline where assistance is needed.
- Report product faults and concerns to the manufacturer in a timely manner.

## Customer Service

- Show the customer any identity card that is relevant to the work being carried out prior to commencement or on request.
- Give a full and clear explanation/demonstration of the product or system and its operation to the customer.
- Hand over the manufacturer's instructions, including the Benchmark Checklist, to the customer on completion of an installation.
- Obtain the customer's signature, on the Benchmark Checklist, to confirm satisfactory demonstration and receipt of manufacturer's instructions.
- Advise the customer that regular product servicing is needed, in line with manufacturers' recommendations, to ensure that safety and efficiency is maintained.
- Respond promptly to calls from a customer following completion of work, providing advice and assistance by phone and, if necessary, visiting the customer.
- Rectify any installation problems at no cost to the customer during the installer's guarantee period.



\*The use of the word "installer" is not limited to installation itself and covers those carrying out installation, commissioning and/or servicing of heating and hot water products, or the use of supporting products (such as water treatment or test equipment).

\*\*Customer includes householders, landlords and tenants.

© Heating and Hotwater Industry Council (HHIC)

[www.centralheating.co.uk](http://www.centralheating.co.uk)



# Benchmark Commissioning and Servicing Section

It is a requirement that the boiler is installed and commissioned to the manufacturer's instructions and the data fields on the commissioning checklist completed in full.

To instigate the boiler guarantee the boiler needs to be registered with the manufacturer within one month of the installation.

To maintain the boiler guarantee it is essential that the boiler is serviced annually by a Gas Safe registered engineer who has been trained on the boiler installed. The service details should be recorded on the Benchmark Service Interval Record and left with the householder.



[www.centralheating.co.uk](http://www.centralheating.co.uk)

© Heating and Hotwater Industry Council (HHIC)

# GAS BOILER SYSTEM COMMISSIONING CHECKLIST

This Commissioning Checklist is to be completed in full by the competent person who commissioned the boiler as a means of demonstrating compliance with the appropriate Building Regulations and then handed to the customer to keep for future reference.

Failure to install and commission according to the manufacturer's instructions and complete this Benchmark Commissioning Checklist will invalidate the warranty. This does not affect the customer's statutory rights.

Customer name:				Telephone number:					
Address:									
Boiler make and model:									
Boiler serial number:									
Commissioned by (PRINT NAME):				Gas Safe register number:					
Company name:				Telephone number:					
Company address:									
				Commissioning date:					
<b>To be completed by the customer on receipt of a Building Regulations Compliance Certificate*</b>									
Building Regulations Notification Number (if applicable):									
<b>CONTROLS</b> (tick the appropriate boxes)									
Time and temperature control to heating	Room thermostat and programmer/timer			Programmable room thermostat					
	Load/weather compensation			Optimum start control					
Time and temperature control to hot water	Cylinder thermostat and programmer/timer			Combination Boiler					
Heating zone valves	Fitted			Not required					
Hot water zone valves	Fitted			Not required					
Thermostatic radiator valves	Fitted			Not required					
Automatic bypass to system	Fitted			Not required					
Boiler interlock				Provided					
<b>ALL SYSTEMS</b>									
The system has been flushed and cleaned in accordance with BS7593 and boiler manufacturer's instructions							Yes		
What system cleaner was used?									
What inhibitor was used?							Quantity	litres	
Has a primary water system filter been installed?							Yes	No	
<b>CENTRAL HEATING MODE</b> measure and record:									
Gas rate	m <sup>3</sup> /hr		<b>OR</b>		ft <sup>3</sup> /hr				
Burner operating pressure (if applicable)	mbar		<b>OR</b> Gas inlet pressure		mbar				
Central heating flow temperature							°C		
Central heating return temperature							°C		
<b>COMBINATION BOILERS ONLY</b>									
Is the installation in a hard water area (above 200ppm)?							Yes	No	
If yes, and if required by the manufacturer, has a water scale reducer been fitted?							Yes	No	
What type of scale reducer has been fitted?									
<b>DOMESTIC HOT WATER MODE</b> Measure and Record:									
Gas rate	m <sup>3</sup> /hr		<b>OR</b>		ft <sup>3</sup> /hr				
Burner operating pressure (at maximum rate)	mbar		<b>OR</b> Gas inlet pressure at maximum rate		mbar				
Cold water inlet temperature							°C		
Hot water has been checked at all outlets							Yes	Temperature	°C
Water flow rate							l/min		
<b>CONDENSING BOILERS ONLY</b>									
The condensate drain has been installed in accordance with the manufacturer's instructions and/or BS5546/BS6798							Yes		
<b>ALL INSTALLATIONS</b>									
Record the following:	At max. rate:		CO	ppm	<b>AND</b>	CO/CO <sub>2</sub>	Ratio		
	At min. rate: (where possible)		CO	ppm	<b>AND</b>	CO/CO <sub>2</sub>	Ratio		
The heating and hot water system complies with the appropriate Building Regulations							Yes		
The boiler and associated products have been installed and commissioned in accordance with the manufacturer's instructions							Yes		
The operation of the boiler and system controls have been demonstrated to and understood by the customer							Yes		
The manufacturer's literature, including Benchmark Checklist and Service Record, has been explained and left with the customer							Yes		
Commissioning Engineer's Signature									
Customer's Signature									
(To confirm satisfactory demonstration and receipt of manufacturer's literature)									

\* All installations in England and Wales must be notified to Local Authority Building Control (LABC) either directly or through a Competent Persons Scheme. A Building Regulations Compliance Certificate will then be issued to the customer.



## SERVICE RECORD

It is recommended that your heating system is serviced regularly and that the appropriate Service Interval Record is completed.

### Service Provider

Before completing the appropriate Service Record below, please ensure you have carried out the service as described in the manufacturer's instructions. Always use the manufacturer's specified spare part when replacing controls.

<b>SERVICE 01</b>		Date:	
Engineer name:			
Company name:			
Telephone No:			
Gas safe register No:			
Record:	At max. rate:	CO ppm	AND CO <sub>2</sub> %
	At min. rate: (Where Possible)	CO ppm	AND CO <sub>2</sub> %
Comments:			
Signature			

<b>SERVICE 02</b>		Date:	
Engineer name:			
Company name:			
Telephone No:			
Gas safe register No:			
Record:	At max. rate:	CO ppm	AND CO <sub>2</sub> %
	At min. rate: (Where Possible)	CO ppm	AND CO <sub>2</sub> %
Comments:			
Signature			

<b>SERVICE 03</b>		Date:	
Engineer name:			
Company name:			
Telephone No:			
Gas safe register No:			
Record:	At max. rate:	CO ppm	AND CO <sub>2</sub> %
	At min. rate: (Where Possible)	CO ppm	AND CO <sub>2</sub> %
Comments:			
Signature			

<b>SERVICE 04</b>		Date:	
Engineer name:			
Company name:			
Telephone No:			
Gas safe register No:			
Record:	At max. rate:	CO ppm	AND CO <sub>2</sub> %
	At min. rate: (Where Possible)	CO ppm	AND CO <sub>2</sub> %
Comments:			
Signature			

<b>SERVICE 05</b>		Date:	
Engineer name:			
Company name:			
Telephone No:			
Gas safe register No:			
Record:	At max. rate:	CO ppm	AND CO <sub>2</sub> %
	At min. rate: (Where Possible)	CO ppm	AND CO <sub>2</sub> %
Comments:			
Signature			

<b>SERVICE 06</b>		Date:	
Engineer name:			
Company name:			
Telephone No:			
Gas safe register No:			
Record:	At max. rate:	CO ppm	AND CO <sub>2</sub> %
	At min. rate: (Where Possible)	CO ppm	AND CO <sub>2</sub> %
Comments:			
Signature			

<b>SERVICE 07</b>		Date:	
Engineer name:			
Company name:			
Telephone No:			
Gas safe register No:			
Record:	At max. rate:	CO ppm	AND CO <sub>2</sub> %
	At min. rate: (Where Possible)	CO ppm	AND CO <sub>2</sub> %
Comments:			
Signature			

<b>SERVICE 08</b>		Date:	
Engineer name:			
Company name:			
Telephone No:			
Gas safe register No:			
Record:	At max. rate:	CO ppm	AND CO <sub>2</sub> %
	At min. rate: (Where Possible)	CO ppm	AND CO <sub>2</sub> %
Comments:			
Signature			

<b>SERVICE 09</b>		Date:	
Engineer name:			
Company name:			
Telephone No:			
Gas safe register No:			
Record:	At max. rate:	CO ppm	AND CO <sub>2</sub> %
	At min. rate: (Where Possible)	CO ppm	AND CO <sub>2</sub> %
Comments:			
Signature			

<b>SERVICE 10</b>		Date:	
Engineer name:			
Company name:			
Telephone No:			
Gas safe register No:			
Record:	At max. rate:	CO ppm	AND CO <sub>2</sub> %
	At min. rate: (Where Possible)	CO ppm	AND CO <sub>2</sub> %
Comments:			
Signature			

\* All installations in England and Wales must be notified to Local Authority Building Control (LABC) either directly or through a Competent Persons Scheme. A Building Regulations Compliance Certificate will then be issued to the customer.



# FLOWCHART FOR CO LEVEL AND COMBUSTION RATIO CHECK ON COMMISSIONING A CONDENSING BOILER

## Important Preliminary Information on Checks

The air gas ratio valve is factory-set and must not be adjusted DURING COMMISSIONING.

If the boiler requires conversion to operate with a different gas family (e.g. conversion from natural gas to LPG) separate guidance is provided with the conversion kit supplied and this must be followed.

### PRIOR TO CO LEVEL AND COMBUSTION RATIO CHECK

The installation instructions must have been followed, gas type verified and gas supply pressure / gas rate checked as required prior to commissioning.

As part of the installation process, ESPECIALLY WHERE A FLUE HAS BEEN FITTED BY PERSONS OTHER THAN THE BOILER INSTALLER, visually check the integrity of the whole flue system to confirm that all components are correctly assembled, fixed and supported. Check that maximum flue lengths have not been exceeded and all guidance has been followed (e.g. Gas Safe Register Technical Bulletin (TB) 008 where chimney/flues are in voids).

The ECGA should be of the correct type, as specified by BS 7967.

Prior to its use, the ECGA should have been maintained and calibrated as specified by the manufacturer. The installer must have the relevant competence for use of the analyser.

Check and zero the analyzer IN FRESH AIR in accordance with the analyzer manufacturer's instructions.

#### KEY:

**CO** = carbon monoxide

**CO<sub>2</sub>** = carbon dioxide

**O<sub>2</sub>** = oxygen

**Combustion Ratio** = The CO reading measured in ppm divided by the CO<sub>2</sub> reading first converted to ppm

**ppm** = parts per million

**GS(I&U)R** = Gas Safety (Installation and Use) Regulations

#### \* Setting to Minimum Rate:

Refer to Service Mode, Minimum Rate (Page 71 & 72)



# PRIWA & PRIWA PLUS ENERWA & ENERWA PLUS

FOR ANY TECHNICAL QUERIES PLEASE RING THE  
WARMHAUS CONSUMER / INSTALLER / TECHNICAL HELPLINE:

01234 510 010  
Consumer Helpline

01234 510 020  
Technical Helpline

# CONDENSING COMBI BOILERS INSTALLATION, USER & SERVICE MANUAL

Instruction booklet code of Priwa/Enerwa: 150.11.606.000010  
Revision number / Date: R01/08.2017