

HEATTM
LINE

S24/S30 COMPACT
Wall Mounted
Combination Boiler

Installation, Servicing and
User Instructions

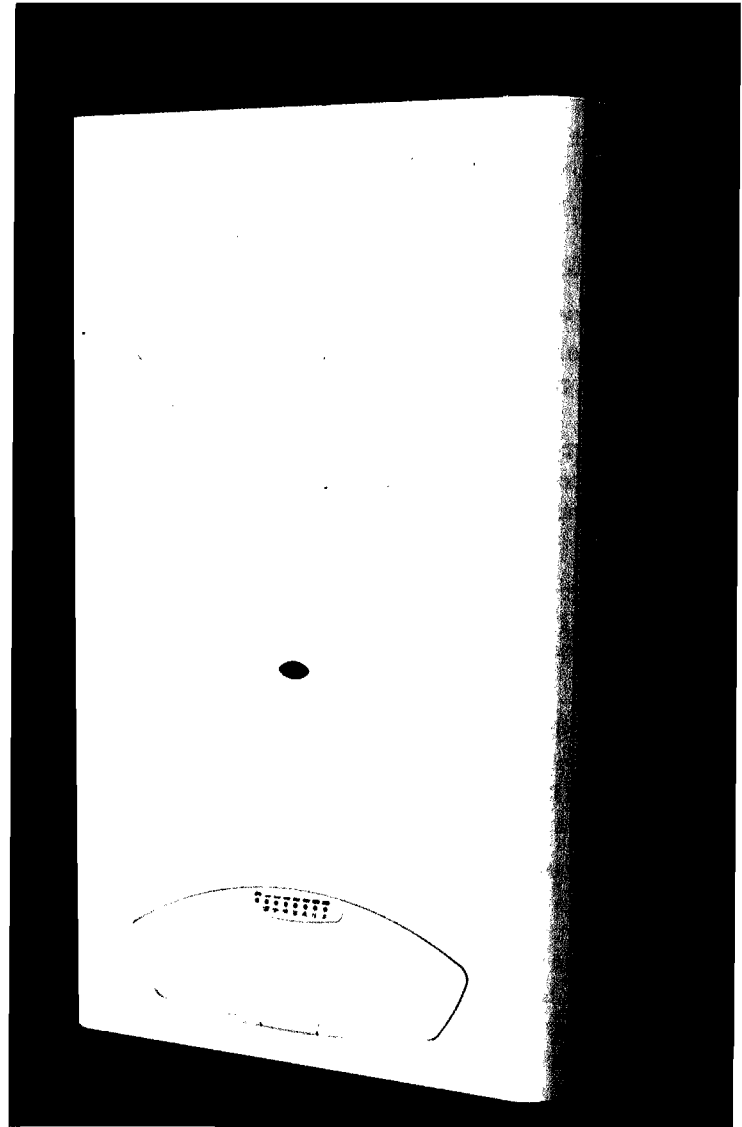

Natural Gas

Heat Line™ S24/S30 Compact Combi

British Gas Service Listing

S24 Compact G.C.N° 47-157-02

S30 Compact G.C.N° 47-157-03

The Heat Line™ range of heating boilers are manufactured from high quality materials, enabling reliability and optimum performance.

Heat Line™ are committed to the continual development of their appliances to ensure their customers benefit from the latest advances in combustion technology and energy savings.

WRAS
APPROVED
PRODUCT

No: 0302093

benchmark
COLLECTIVE MARK

i Central
Heating
Information
Council

Type test for purpose of Regulation 5 certified by:

Notified Body Gastec **CE 0694** PIN NO: 0694BO4118

Product/Production certified by:

Notified Body Gastec **CE 0694** PIN NO: 0694BO4118

The manufacturer, in the continuous process to improve his products, reserves the right to modify the data expressed in the present documentation at any time and without prior notice. The present documentation is an informative support and it cannot be considered as a contract towards third parties.

'Benchmark' Log Book

As part of the industry-wide initiative the S24/S30 Compact comes complete with an Installation, Commissioning and Service Record Log Book. Please read the Log book carefully and complete all sections relevant to the appliance and installation. The details within the Log Book will be required in the event of any warranty work.

On completion the Log Book must be left with the end user and the relevant sections completed on each subsequent Service visit.

Contents

Section	Page
Preface	3
Signs on Box and Boiler	4
1. Installation Regulations	5
2. Technical Data	6
3. Boiler Characteristics	8
4. Operation	9
5. General Installation	11
6. Appliance Siting	13
7. Flue Terminal Location	14
8. Flue (General)	16
9. Electrical Connections	18
10. Boiler Installation	20
11. Gas Supply	24
12. Filling the System	24
13. Control Panel Functions	26

Section	Page
14. Commissioning	27
15. Onboard Adjustments	28
16. Safety Devices	30
17. Routine Servicing	32
18. Component Replacement	34
19. Gas Type Conversion	46
20. Fault Finding Chart	47

Appendices	
Appendix 1. Spare Parts List	53

User Instructions

Preface

The Heat Line™ 'S24/S30 Compact' gas fired combination boiler meets the requirements of Statutory Instrument 'The Boiler (Efficiency) Regulations' and is deemed to meet the requirements of:

- ❑ Gas Appliance Directive 90/396 EEC
- ❑ Efficiency Directive 92/42/ EEC
- ❑ Low Voltage Directive 73/23 EEC (modified from 93/68) and;
- ❑ Electromagnetic Compatibility Directive 89/396 EEC (modified from 93/68)

Heat Line™ declare that the materials used in the manufacturer of this appliance are non-hazardous and that no substances harmful to health are contained within the appliance.

The S24/S30 Compact must be installed in accordance with these instructions and the regulations currently in force. Read these instructions fully before installing or using the appliance.

Heat Line™ accepts no responsibility for unsatisfactory performance of the appliance or flue arising from the failure to comply with the installation and user instructions.

If the boiler is sold or installed to another customer, all of the documents must be transferred from existing customer to the new one.

'Benchmark' Log Book

As part of the industry-wide initiative the S24/S30 Compact comes complete with an Installation, Commissioning and Service Record Log Book. Please read the Log book carefully and complete all sections relevant to the appliance and installation. The details within the Log Book will be required in the event of any warranty work.

On completion the Log Book must be left with the end user and the relevant sections completed on each subsequent Service visit.

The Signs on Box



The sign of quality: S24/S30 Compact combination boiler is certified by GASTEC Italy.



S24/S30 Compact combination boiler must be avoided from taking damage by falling etc.



Keep away the box from water, rain etc.



S24/S30 Compact can be stored up to 5 boiler in one column.

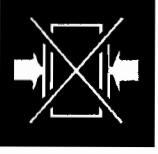

No pressure from sides of the box must be applied.



This Way Up: The box must be stored in the position that this arrow shows up.

The Signs on Boiler



Room Thermostat: This sign is placed on the left side on the control panel plastic and describes the room thermostat connection.



Warning! High Voltage: This sign is placed on the rear side of control panel plastic and describes that there is high voltage on main PCB. If servicing will be carried out on main PCB by opening the cover, electric supply must be turned OFF.



Potentiometer Cover: This sign is placed on the rear side of control panel plastic and shows that the potentiometers can be reached by removing this cover to make further adjustments.

1. Installation Regulations

- 1.1. A qualified C.O.R.G.I. registered engineer in accordance with the Gas Safety (Installation and Use) Regulations; October 1994 must only install this appliance. Failure to install appliances correctly could lead to prosecution.
- 1.2. All C.O.R.G.I. Registered Installers carry a C.O.R.G.I. ID card and have a registration number, which should be recorded and entered on your benchmark log book. You can check your Installer registration by contacting C.O.R.G.I. on 01256 372300
- 1.3. The manufactures instructions must not be taken as overriding statutory requirements.
- 1.4. The installation of this appliance must be in accordance with the relevant requirements of the Gas Safety (Installation and Use) Regulations 1984 as amended, Building Regulations, Building Standards (Scotland), IEE Wiring Regulations (BS 7671), Health and Safety Document No.635 (Electricity at Work Regulations) and Local Water Authority bye laws.
- 1.5. It should also be in accordance with the relevant recommendations contained within the current versions of the following British Standards.

- BS 6798 Specification for installation of gas fired hot water boilers of rated input not exceeding 60 kW.
- BS 5449 Central Heating for Domestic Premises.
- BS 5546 Installation of gas hot water supplies for domestic purposes.
- BS 5440 Flues and Ventilation for gas appliances of rated input not exceeding 60 kW. (Part 1 Flues).
- BS 5440 Flues and Ventilation for gas appliances of rated input not exceeding 60kW (Part 2 Air Supply).
- BS 6891 Installation of low pressure gas pipework installations up to 28mm (R1).

Reference should also be made to British Gas Guidance Notes for the Installation of Domestic Gas Boilers.

- 1.6. To ensure that the installation will perform to the highest standards, the system and components should conform to any other relevant British Standards in addition to those mentioned in the instructions.
- 1.7. **For Installation in Ireland** the appliance must be installed in compliance with I.S.813 'Installation of gas appliances'.

For further advice or information contact Heat Line™ Service Enquiries by telephone on **08706 092091** or e-mail at our web site www.heatline.co.uk

2. Technical Data

		S24	S30
Gas Category	II _{2H3+}		
Gas inlet pressure G20 Gas inlet p. G30 / G31	mbar	20 28-30/37	
Heat Input (Q _{max})	kW (Btu/h)	25.7 87750	32.1 109262
Heat Output (P _{max})	kW (Btu/h)	24 81946	30 102455
Heat Input (Q _{min})	kW (Btu/h)	10 34144	11.5 37558
Heat Output (P _{min})	kW (Btu/h)	9 30729	10.1 34144
Useful efficiency at 100% load	%	93.3	93.6
Useful efficiency at 30% load	%	90.1	88
Burner injector	mm.	1·23	1·20
Inlet Pressure (Natural Gas)	mbar	20	
Burner Pressure (Natural Gas)	mbar	Max 12.7 Min 1.6	Max 15 Min 1.7
Gas Rate (Natural Gas)	m ³ /h	Max 2.79 Min 1.07	Max 3.48 Min 1.25
	g/s	Max 5.02 Min 2.14	Max 6.95 Min 2.5

Power supply	Input	230 V 50 Hz	
Max. power consumption	Watts	164	
Level of protection	IPX4D		
Boiler water content	Litres	0.75	0.8
Maximum heating temperature	°C	85°	
Max. domestic hot water temperature	°C	64°	
Operating pressure (Bar)	PMS (Min)	3 (0·8)	
Domestic water supply pressure (Bar)	PMS (Min)	8 (0·25)	
Expansion Vessel	Capacity (litres)	7	
Expansion Vessel	Pre-Charge (bar)	0·5	
Domestic Water Supply Output. (litres/min)	35°C ΔT	9.82	12.3
	30° C ΔT	11.46	14.3
	25°C ΔT	13.76	17.2
Air Intake Pipe	Diameter (mm)	100	
Flue Pipe	Diameter (mm)	60	
CO / CO ₂ Ratio at Max. Input	0.001366	0.001014	

CO / CO ₂ Ratio at Min. Input	0.008939	0.00205	
Nitrogen oxide (NOx) Emissions at Max. Input (NOx Class 3)	ppm	142	162
Nitrogen oxide (NOx) Emissions at Min. Input (NOx Class 3)	ppm	77	84
Combustion products temperature	°C	114.3	128
Case Dimensions (mm)	330d x 405w x 720h (S24) 330d x 430w x 720h (S30)		
Shipping weight	kg	38	39
Dry weight	kg	35	36

G30 / 31 Version			
Burner injector	mm.	0.76	
Burner Pressure	mbar	27.8	
Gas Rate	Kg/h	1.78	2.1

Figure 1.

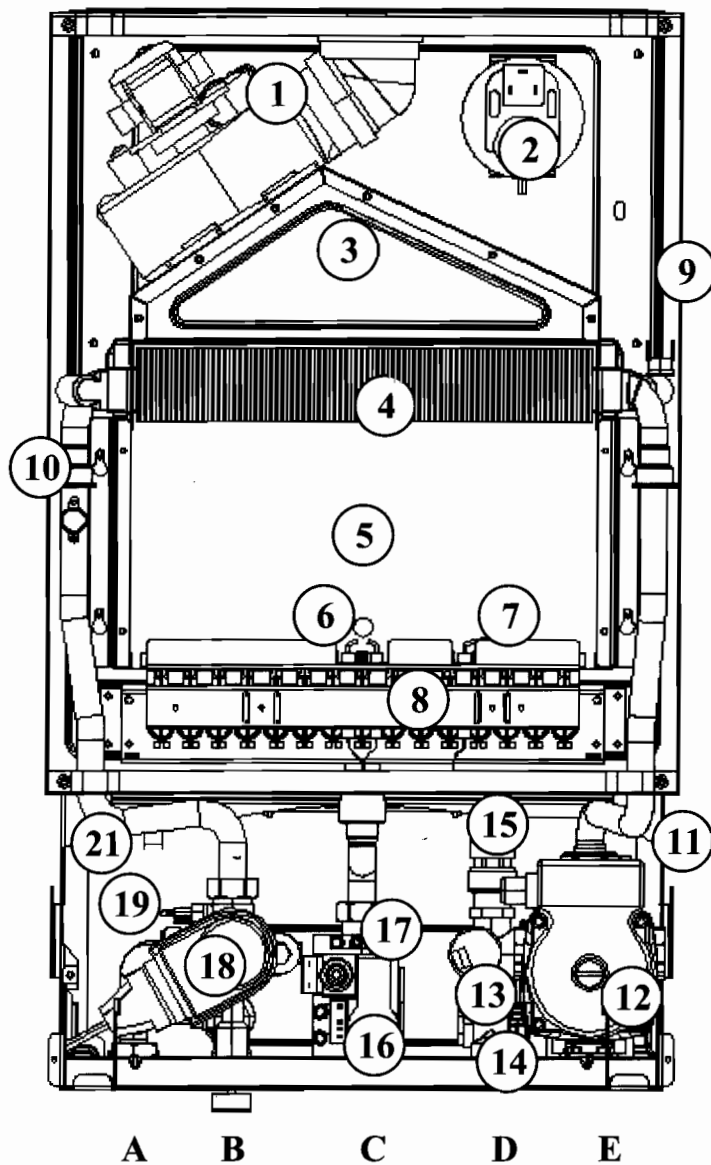

Key

- 1 - Fan
- 2 - Air Pressure Switch
- 3 - Fan Hood
- 4 - Primary Heat Exchanger
- 5 - Combustion Chamber
- 6 - Ignition Electrode
- 7 - Flame Sensor Electrode
- 8 - Burner
- 9 - Overheat Safety Thermostat-1
- 10 - Heating Sensor
- 11 - Automatic Air Vent
- 12 - Pump
- 13 - Water Pressure Switch/Sensor
- 14 - D.H.W. Flow Sensor
- 15 - Heating Safety Valve
- 16 - Gas Valve
- 17 - Secondary Heat Exchanger
- 18 - Three-Port Valve
- 19 - D.H.W. Sensor
- 20 - Expansion Vessel (At rear of the boiler)
- 21 - Overheat Safety Thermostat-2

- A - Heating Flow (22mm)
- B - D.H.W. Outlet (15mm)
- C - Gas Inlet (22mm)
- D - Cold Water Inlet (15mm)
- E - Heating Return (22mm)

3. Boiler Characteristics.

- 3.1** The Heat Line 'S24/S30 Compact' is a fan flued, wall-mounted combination boiler that supplies both central heating and mains fed domestic hot water. Being room sealed the boiler may be installed in any room or internal compartment without the need for purpose made ventilation. A functional diagram of the boiler's principal components is given as *figure 1*.
- 3.2** Range rated (from 9 kW to 24 kW for S24 Compact, from 10.1 kW to 30 kW for S30 Compact) heat output can be focused to match the designed heating systems requirements by a simple adjustment.
- 3.3** An electronic control unit, consisting of a PCB which includes ignition module provides direct burner ignition and flame supervision along with continuous modulation of the burner's gas supply.
- 3.4** An interface unit, which includes boiler adjustment potentiometers and fault display provides easy service ability to the boiler.
- 3.5** Heat transfer to the boiler's primary hydraulic circuit is obtained via a primary, gas to water heat exchanger contained within a hermetically sealed combustion chamber. A 230 volt, single speed fan expels the products of combustion from the combustion chamber to outside air via an associated flue system. The fan is activated at the beginning of each ignition cycle and its operation monitored by means of negative and positive sensing points connected to an air pressure switch.
- 3.6** A secondary heat exchanger allows the instantaneous transferral of heat from the primary hydraulic circuit to water destined for domestic hot water use. The secondary heat exchanger is sized so as to minimise thermal shock and is protected against the build up of lime scale by limiting the D.H.W. outlet water temperature to a maximum of 64°C.
- 3.7** An integral pump located in the boilers main hydraulic circuit circulates water through the primary heat exchanger to either the central heating circuit or D.H.W. heat exchanger, depending on the demand. In the event of reduced or interrupted water circulation in the central heating circuit the primary heat exchanger is protected by an automatic by-pass valve calibrated to ensure a minimum flow of 500-600 litres/hr. A system by-pass should be fitted as far away from the boiler as possible.
- 3.8** Room temperature can be controlled by the use of an external room thermostat or a temperature regulator (timer thermostat with output contact).
- 3.9** The C.H. system temperature can be adjusted due to outdoor temperature by connecting an Outdoor Temperature sensor directly to the main PCB.
- 3.10** Along with an integral time control to allow the setting of central heating periods, the boiler's control panel incorporates a LED diagnostic display for indicating state of operation, fault and defect codes.

4. Operation

4.1 By means of a manual function switch, the S24/S30 Compact can be set to operate in one of two operating modes, domestic hot water only or domestic hot water and central heating.

4.2 Depending on demand, water in the primary hydraulic circuit is diverted to either the central heating system or internal circulation for heating the D.H.W. through the secondary heat exchanger via an electric motor driven three port valve situated on the boiler's hydraulic block. A schematic diagram showing the flow within the boiler's hydraulic circuit is given as *figure 2*.

Figure 2

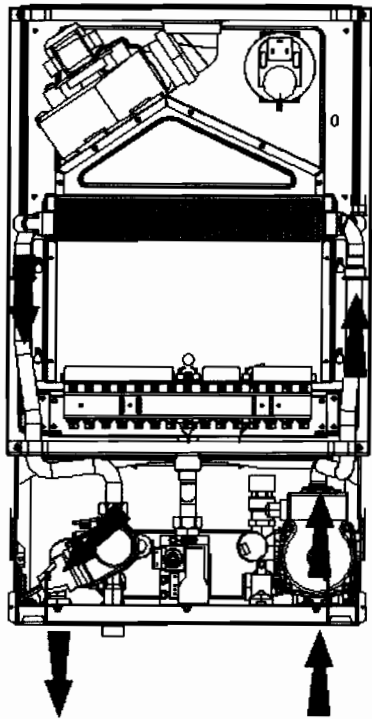

4.3 DOMESTIC HOT WATER MODE:

- When hot water demand is requested the boiler will fire automatically. An integral pump is energised and hot water from the boiler's primary circuit is circulated through the secondary heat exchanger, allowing the instantaneous transferral of heat to the incoming cold water. The boiler's electronic control unit automatically modulates the burner's output to maintain the required temperature of the domestic hot water. Hot water will continue to flow through the tap until no longer required. When the demand for hot water ceases the integral pump and fan will continue to run for a short while (10 seconds) to dissipate any excess heat within the boiler.

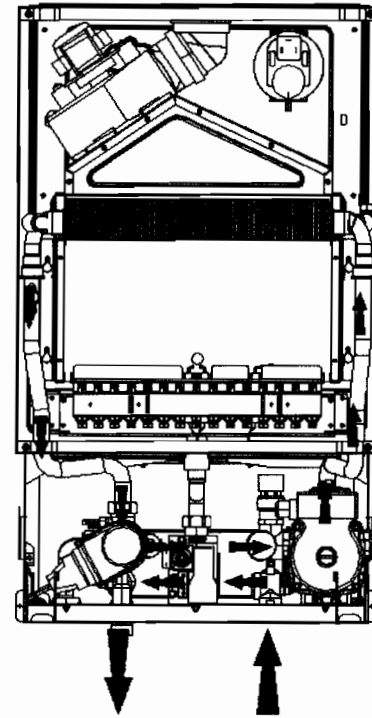

4.4 DOMESTIC HOT WATER AND CENTRAL HEATING MODE:

- ❑ When heating demand is requested the boiler will fire automatically. An integral pump is then energised and hot water from the boilers primary circuit is circulated around the central heating systems pipework and radiators. The boiler's electronic control unit automatically modulates the burner's output to match the heating demand. As the water temperature of the heating system increases the gas input to the burner decreases, conserving energy and increasing efficiency. When the demand for central heating is no longer present the burner will shut down and the boiler will revert to stand-by, waiting to respond to the next heating demand. The pump will operate for a while to dissipate any excess heat within the boiler.

Note.

A demand for domestic hot water will override the central heating mode for the period of the request. When domestic hot water is no longer required the boiler will automatically return to the central heating mode of operation with or without a delay. NB A 45 second delay will occur before boiler switches back into central heating function if the No.3 dip switch is set to OFF position.

5. General Installation

5.1 Installer Testing & Commissioning Tips

- Installer shall instruct the user in the operation of the boiler and the safety devices and shall give the installation, servicing and user instructions to the user after installation of the boiler.
- The user should be instructed to keep the servicing instructions in a safe place.
- It is important to keep the boiler clear of dust during the installation. In particular, do not allow debris to enter the top of the boiler where the flue connection is made. This may cause the fan outlet to get blocked or combustion chamber to fill with debris and will, of course, cause the boiler to fail to ignite on first ignition. It is recommended that you check the fan outlet before you light the boiler.
- Before you fit the boiler ensure that the pipe work that you are installing is connected to the appropriate connections on the boiler i.e. cold water pipe to cold water inlet, hot water outlet to the hot water tap.
- Because the boiler is live tested, at the end of each production stage, a small amount of water will remain within the boiler. Please ensure that you spin the pump rotor manually before ignition.
- Remember to flush out the system, both cold and hot, in order to remove the debris from the system. This should be done particularly where boilers are being fitted to existing radiator circuits.
- Refer to BS 7593:1992 for the details to clean DHW and Central heating system.
- Remember to release the small cap on top of the auto air purge device on the pump, 1 turn, before filling. This will ensure that air is removed as the system starts up.
- Do not use the pressure relief valve as a means of flushing the system, please use the valve at the bottom of the pump. Discharging water from the system from the pressure relief valve may allow water to seep after you have left the job, so this may cause the boiler to lose pressure and debris to collect on the seating.
- The boiler is fitted with a cold water inlet filter on the inlet side of the hydraulic block. If the central heating works but you are unable to obtain or even fire the boiler in hot water mode, it is highly likely this filter is blocked. If you are able to obtain hot water but no central heating, then it is advisable, in first instance, to check the clock connections, the room stat is turned up fully and the clock has been set to call for heat.
- Do not forget that when domestic hot water has been requested and if No.3 dip switch is set to OFF position, a 45-second time delay will elapse before the central heating fires when in central heating mode.
- When commissioning remember that the boiler requires 20 mbar gas working pressure at the inlet of the appliance gas valve.
- Between two central heating demand, the time can be adjusted by Anti Cycling Time adjustment trimmer.

If you are in any doubt, please refer to the installation and commissioning guidelines contained within the boiler instruction manuals. If necessary, please contact Heat Line™ Service Enquires for further advice and assistance on **08706 092091**.

DO NOT FORGET IT IS A REQUIREMENT TO FULLY COMPLETE YOUR BENCHMARK CODE OF PRACTICE LOG BOOK IN ALL INSTANCES.

- 5.2 The S24/S30 Compact is suitable for use only on fully pumped, pressurised, sealed systems operating with a maximum design flow temperature of 90°C.
- 5.3 The boiler's integral expansion vessel is pre-charged to a pressure of 0.5 bar and will accommodate a system volume up to 125 litres for an average water temperature of 75°C and maximum system pressure of 3 bar. If, when operating at maximum design flow temperature, the system pressure is greater than 3 bar then an additional expansion vessel must be fitted to the system. A typical installation of an additional expansion vessel is given as *figure 3*.

Figure 3.

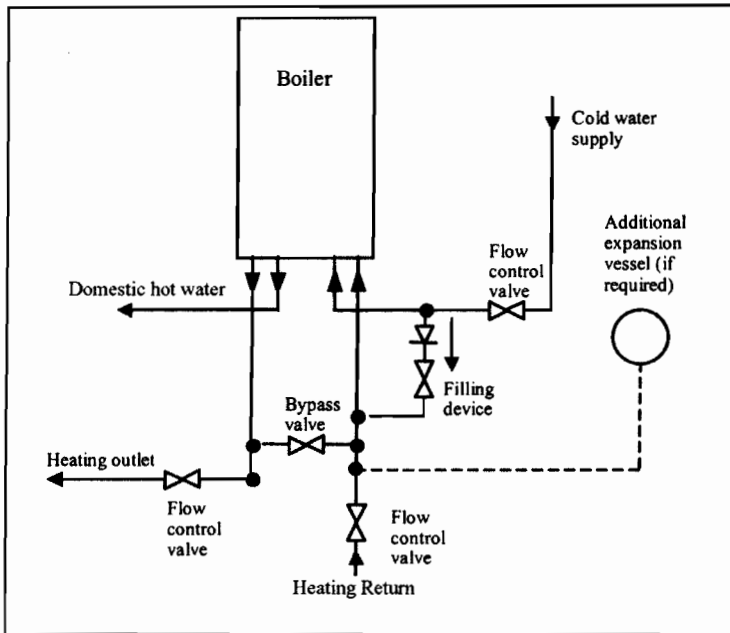

- 5.4 The system pipework layout must be sized and designed to ensure a minimum flow rate of 1300 litres/hr and a maximum differential of 20°C across the boiler flow and return pipes.
- 5.5 Existing heating systems must be thoroughly flushed in accordance with the recommendations of BS7593 prior to installing the boiler.
- 5.6 The system and boiler should be protected by a suitable anti corrosion inhibitor.
- 5.7 On installation it must be ensured that the boiler's heat exchanger is not a natural collecting point for air and where possible, the system pipework should have a gradient to ensure air is carried naturally to other purpose made, air release points.
- 5.8 The system's water must always be allowed to circulate whenever the circulation pump is running. A return by-pass or a non-thermostatic radiator must always be provided in zoned systems and systems with thermostat-controlled radiator valves. The system by-pass should be fitted as far away from the boiler as possible.
- 5.9 In high water capacity systems or under floor heating systems where prolonged operation of the boiler is expected at temperatures below 60°C, please contact Heat Line™ Service Enquires for further advice and assistance on 08706 092091.
- 5.10 The relief valve discharge must be directed away from any electrical component or where it could cause a hazardous situation.

- 5.11** To enable correct drainage of the system drain cocks to BS2879 must be fitted to the lowest points in the system pipework.
- 5.12** For correct domestic hot water application the incoming water supply connection to the boiler should be the first from the main and capable of delivering a minimum inlet pressure of 0.25 bar and flow rate of 2.5 litres/minute. Where inlet pressures exceed 8 bar, a pressure regulator must be fitted to the cold water supply.
- 5.13** Where cold water mains are fitted with a water meter, check valve(s) or loose jumper stopcock, a domestic hot water mini-expansion vessel should be fitted.
- 5.14** Although the S24/S30 Compact is designed to inhibit the formation of scale, in hard water areas above 200mg/litre, a proprietary scale reducer should be fitted in the cold water supply to the boiler.
- 5.15** To ensure economic use of domestic hot water, it is recommended that pipe runs between the boiler and taps be in 15mm copper, as short as possible and where practical, be insulated to reduce heat loss.
- 5.16** If the boiler will not be used for a long period and there is risk of freezing, the electric supply must be left ON and all the central heating isolation valves must be open. Then the boiler will perform frost protection system. Otherwise, if the electric supply will be turned off, central heating system and domestic hot water system must be drained.

6. Appliance Siting

- 6.1** The S24/S30 Compact boiler may be installed in any room or internal compartment and requires no purpose made ventilation for combustion air. If the boiler is to be sited in a room containing a bath or shower then particular reference is drawn to the current I.E.E Wiring Regulations and Building Regulations.
- 6.2** The boiler is not suitable for external installation unless protected by a purpose made building such as a boiler house.
- 6.3** For maintenance purposes the boiler must be installed with a minimum clearance of 200mm above, 300mm below, 600mm to the front and 50mm to each side of the boiler case.
- 6.4** The boiler must be sited at least 1m away from flammable materials and heat sensitive walls must be protected by appropriate insulation.
- 6.5** The boiler must only be mounted on a wall that is capable of supporting the boiler's weight.
- 6.6** To avoid excessive condensation occurring within the boiler flue the boiler should wherever possible, be sited to ensure the shortest possible flue run is utilised.

6.7 For compartment installation the requirements of BS6798 and BS5440: Part2 must be met in particular:

- The compartment must be of sufficient size to permit access for inspection and servicing or the removal of the boiler and any ancillary equipment.
- Any space used for airing clothes or storage must be separated from the appliance by a non-combustible partition. Where the partition is formed from perforated material, then the major dimension of the apertures shall not exceed 13 mm.
- Where the boiler's flue pipe passes through the airing space, it must be protected by a non-combustible sleeve or fire stop having a minimum clearance of 25 mm between the flue pipe and sleeve. In addition, the clearance gap of the flue pipe or its guard through the partition must not exceed 13 mm.
- No combustible surface must be within 75mm of the boiler casing without protection.
- A minimum clearance of 75mm must exist between the compartment door and boiler front.

6.8 Where the boiler is intended for use on **Propane gas** the boiler must not be installed in a room or internal space below ground level.

7. Flue Terminal Location

- 7.1** The flue terminal must be sited with minimum clearance distances as specified in *Figure 4*.
- 7.2** Where the lowest part of the flue terminates below 2m above a balcony, flat roof or ground level, then an appropriate terminal guard should be fitted in accordance with standard EN483 and BS 5440.
- 7.3** Where the flue terminates within 1m of a plastic or painted gutter or within 500mm of painted eaves then protection should be provided in the form of an aluminium shield at least 1m in length, fitted to the underside of the gutter or painted surface.
- 7.4** The flue terminal should not be sited where condensate 'plume' may give rise to a nuisance factor under certain weather conditions.

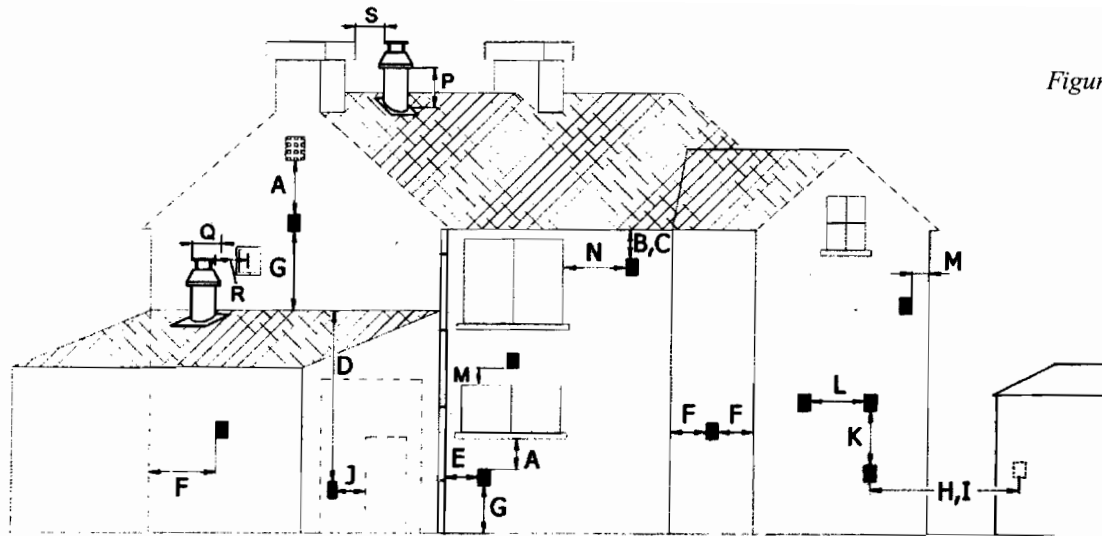
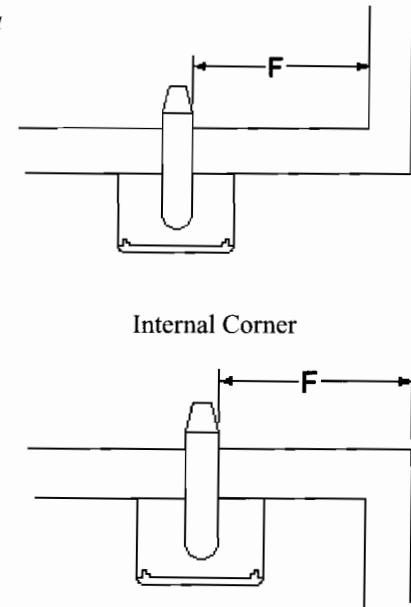
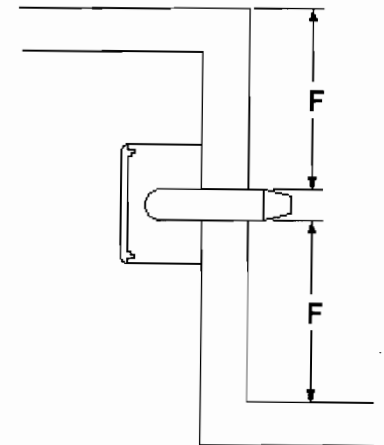

Figure 4



Internal Corner

External Corner



Double Corners

TERMINAL POSITION	MINIMUM DISTANCE
A- Directly below an openable window or other opening e.g. air brick	300 mm
B- Below gutters, soil pipes or drain pipes	75 mm
C- Below eaves	200 mm
D- Below balconies or car front roofs	200 mm
E- From vertical drain pipes and soil pipes	150 mm
F- From internal or external corners	300 mm
G- Above ground, roof or balcony level	300 mm
H- From a surface facing a terminal	600 mm
I- From a terminal discharging towards another terminal	1200 mm
J- From an opening in a car port (e.g. door, window) into a dwelling	1200 mm
K- Vertically from a terminal on the same wall	1500 mm
L- Horizontally from a terminal on the same wall	300 mm
M- Above an opening, air brick, opening windows, etc.	300 mm
N- Horizontally to an opening, air brick, opening windows, etc.	300 mm
P- Above roof level (to base of terminal)	300 mm
Q- From adjacent wall to flue	300 mm
R- From an adjacent opening window	1000 mm
S- From another terminal	600 mm

8. Flue (General)

- 8.1. The S24/S30 Compact boiler employs a concentric flue arrangement consisting of a 60mm-diameter inner flue duct and 100mm-diameter outer air inlet duct.
- 8.2. A standard 700 mm flue kit (figure 5) is supplied with the boiler which can be routed to the rear, left or right of the appliance by means of a 90 degree bend (figure 6). The bend is connected to the boiler by means of connection screws.

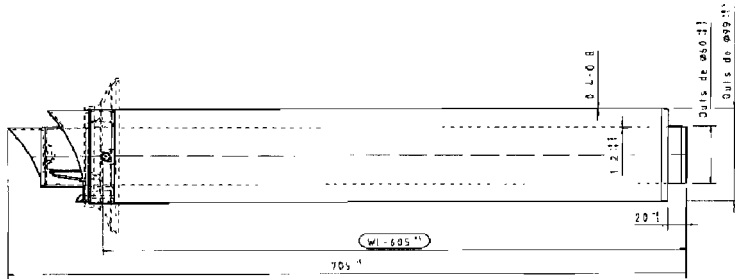

Fig.5

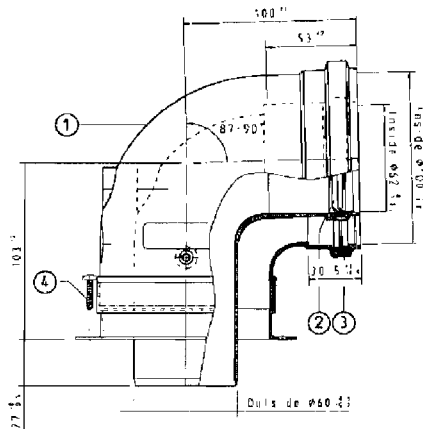

Fig.6

- 8.3. The flue may be lengthened, by means of extensions (available as an optional extra), to a maximum horizontal length of 4 metres using 60/100 flue pipe.

- 8.4. An optional vertical flue kit (figures 8a and 8b) is available to a maximum length of 5 metres using 60/100 flue pipe. The roofterminal is appropriate for flat and pitched roof.
- 8.5. If horizontal and vertical flue lengths are above 1 m the diaphragm on the fan outlet of combination boiler must be removed. The diaphragm can be reached by removing 56° bend on fan outlet (figures 7a, 7b and 7c)
- 8.6. The connection of vertical flue system is similar to the Horizontal flue connection. The system is connected via connection screws. The vertical extension pipes and roof terminal is connected by a clip shown as item 3 on figure 8a.
- 8.7. To avoid condense flowing back into the combustion chamber the flue should be installed with a downward gradient of 3% towards its point of termination.

Note. For each additional 90° elbow (or two 45° elbows) used the maximum flue length must be reduced by 1m.

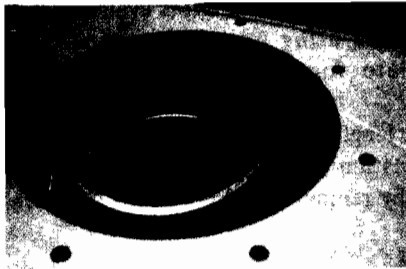

Figure 7a

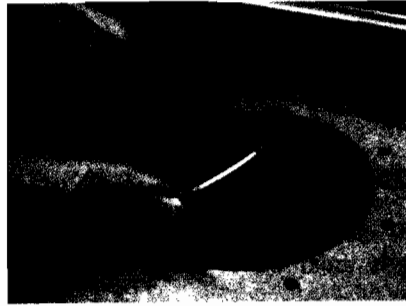

Figure 7b



Figure 7c

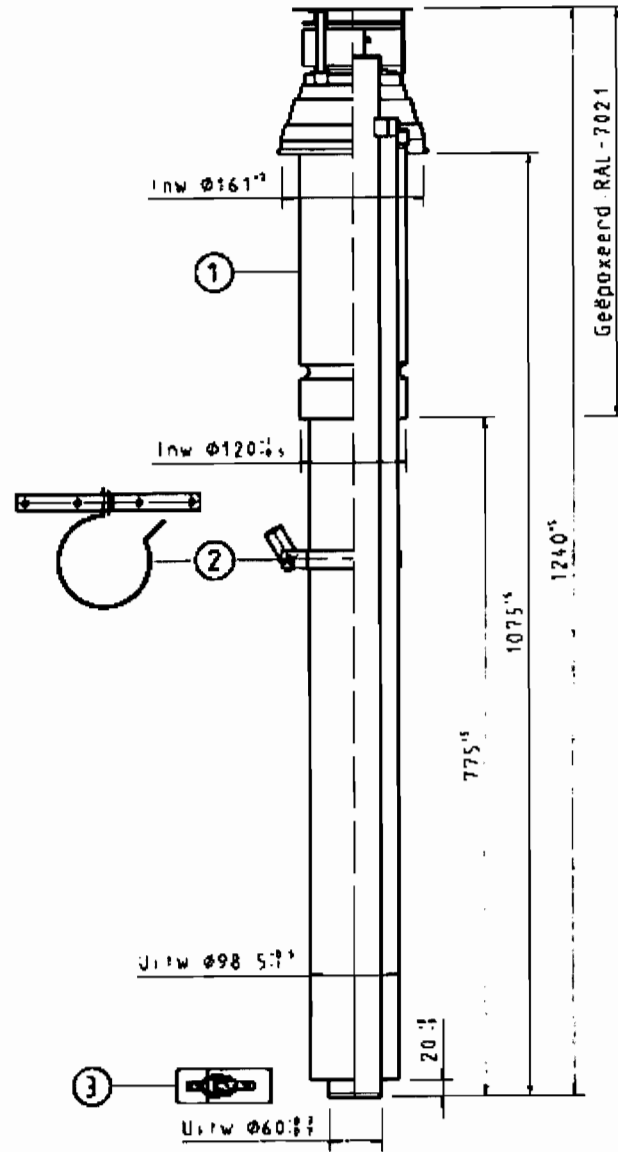

Figure 8a

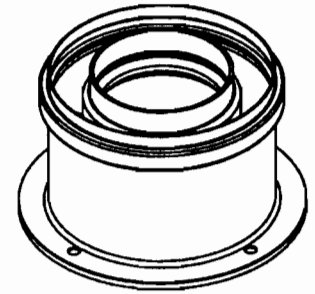

Figure 8b

9. Electrical Connections

9.1 The S24/S30 Compact is supplied factory wired complete with 1.5 m of mains fly lead. All electrical connections to the mains supply must be made in full accordance with the current I.E.E. regulations. Specially prepared mains fly lead can be replaced with a mains fly lead (spare part order code is specified at Appendices) by means of X15 and X3 connectors on electronic control board up to 1.5 m by the installer (*figure 9.1*).

9.2 The boiler must be connected to an effective earth system. Please require a switch for disconnection from the supply having a contact separation of at least 3 mm in all poles, and fused to 4 amp, by the use of a 4 amp fused three pin plug and unswitched shuttered socket outlet providing the boiler is not installed in a room containing a bath or shower. Disconnection must be incorporated in the fixed wiring.

9.3 The point of connection must be readily accessible, adjacent to the appliance and provide complete electrical isolation for the boiler and control system.

9.4 Room thermostat terminal block is located to behind of left side of third plastic cover. On connection of a room thermostat to the boiler, the factory fitted bridge across the room thermostat terminal connectors (*figure 9.2*) must be removed. The connection shown in the figure is low voltage.

9.5 In case of reversed polarity connection, the appliance might not work properly. For this reason it is kindly request that correct polarity on connection to the electrical mains supply is observed.

9.6 While the boiler's main PCB, pump, fan, three-way valve and gas valve are supplied 230V AC, all other components and associated circuits are supplied on extra low voltage.



Figure 9.1

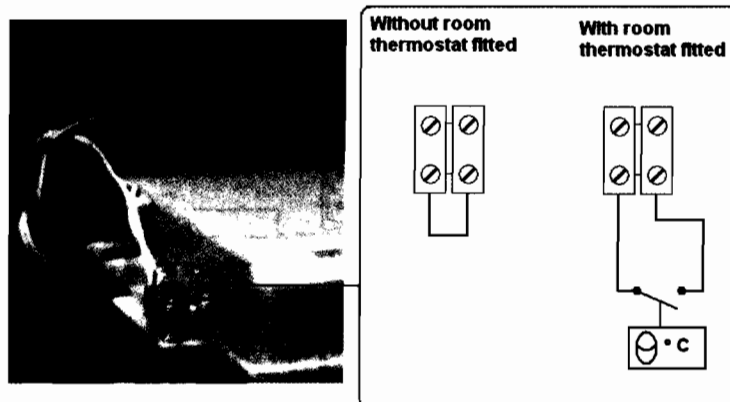
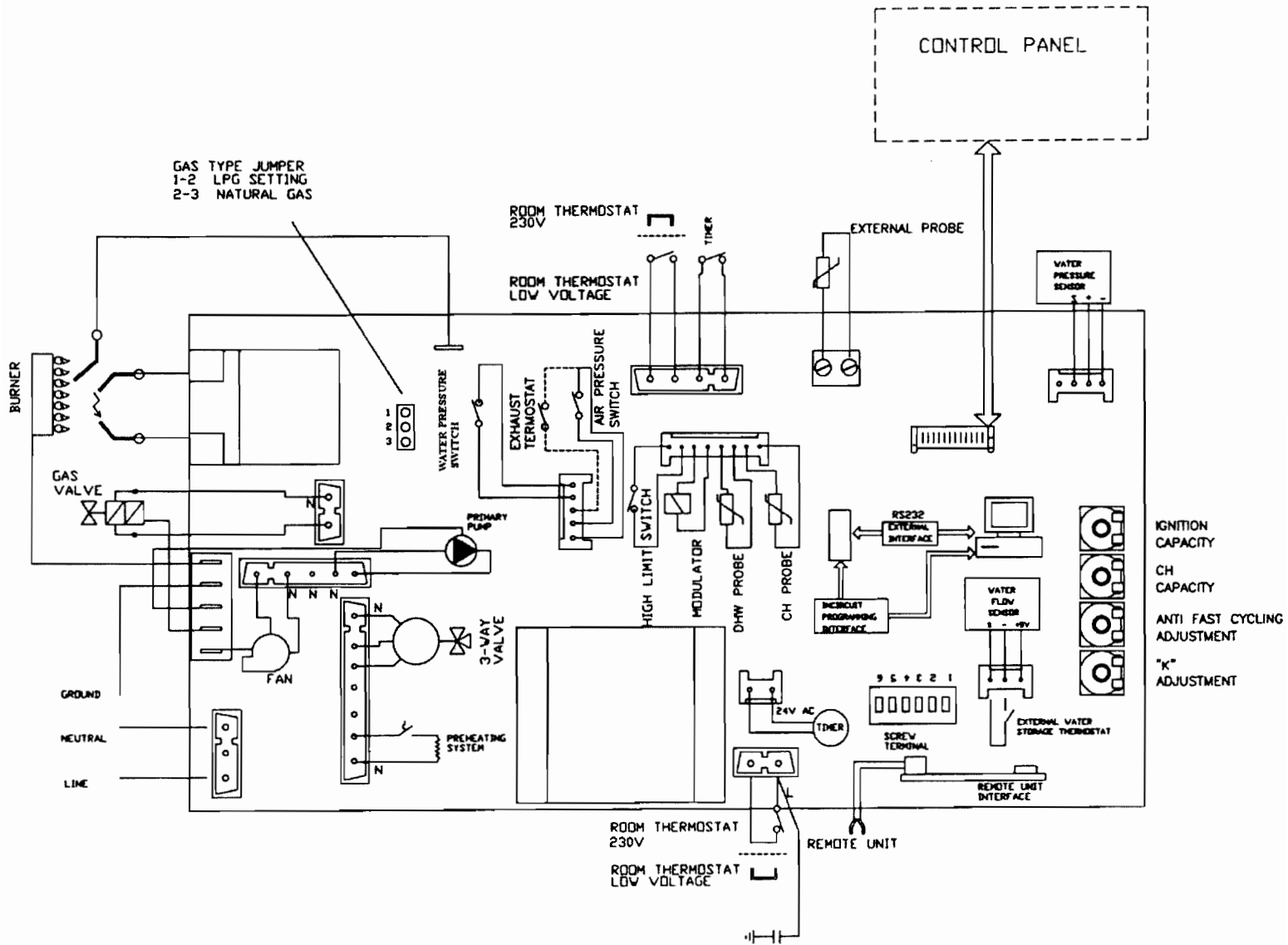

Figure 9.2

9.7 On connecting the mains electrical supply to the boiler, it is essential to ensure that electrical safety checks for earth continuity, earth resistance, polarity and short circuit are carried out prior to making the final connection. A diagram of the boiler's electrical circuit is given as *figure 10*.

Warning: On no account must any external voltage be applied to any of the terminals on the heating control connection plug.



GAS TYPE JUMPER
 1-2 LPG SETTING
 2-3 NATURAL GAS

CONTROL PANEL

ROOM THERMOSTAT
 230V

ROOM THERMOSTAT
 LOW VOLTAGE

EXTERNAL PROBE

WATER
 PRESSURE
 SENSOR

WATER PRESSURE
 SWITCH

EXHAUST
 THERMOSTAT

AIR PRESSURE
 SWITCH

HIGH LIMIT
 SWITCH

MODULATOR

DHW PROBE

CH PROBE

RS232
 EXTERNAL
 INTERFACE

INCUBIT
 PROGRAMMING
 INTERFACE

WATER
 FLOW
 SENSOR

EXTERNAL WATER
 STORAGE THERMOSTAT

IGNITION
 CAPACITY

 CH
 CAPACITY

 ANTI FAST CYCLING
 ADJUSTMENT

 "K"
 ADJUSTMENT

GROUND

 NEUTRAL

 LINE

FAN

PREHEATING
 SYSTEM

PRIMARY
 PUMP

3-WAY
 VALVE

ROOM THERMOSTAT
 230V

ROOM THERMOSTAT
 LOW VOLTAGE

REMOTE UNIT

24V AC
 TIMER

SCREW
 TERMINAL

REMOTE LIMIT
 INTERFACE

IF THE 230VAC THERMOSTAT IS USED
 CONNECT AN 22mF 275VAC CLASSE Y2
 CAPACITOR TO AN EXTERNAL (NOT THE ON-BOARD
 FAST-ON) GROUND CONNECTION.

Figure 10

Important Note.

The mains electrical supply to the S24/S30 Compact must be maintained at all times in order to provide frost protection and antiblocking function (for pump and three port valve). Ensure that the boiler's electrical supply is not interrupted by any external controls.

10. Boiler Installation

10.1 Prior to installing the S24/S30 Compact boiler check that the appliance carton contains: Appliance, Service, Installation and User Manual, Guarantee Card and Benchmark Log Book. Fixing jig, wall hanging bracket, mounting template are packed in a different box. The boiler dimensions are given in *figure 11*.

10.2 Ensure that the boiler is suitable for the gas supply by checking the data plate situated on the inside of the control panel door, and that the system and chosen boiler position is in accordance to Sections 5, 6 and 7 of these instructions.

	A (mm)	B (mm)	C (mm)
S24 Compact	405	169	60/100
S30 Compact	430	169	60/100

Figure 11

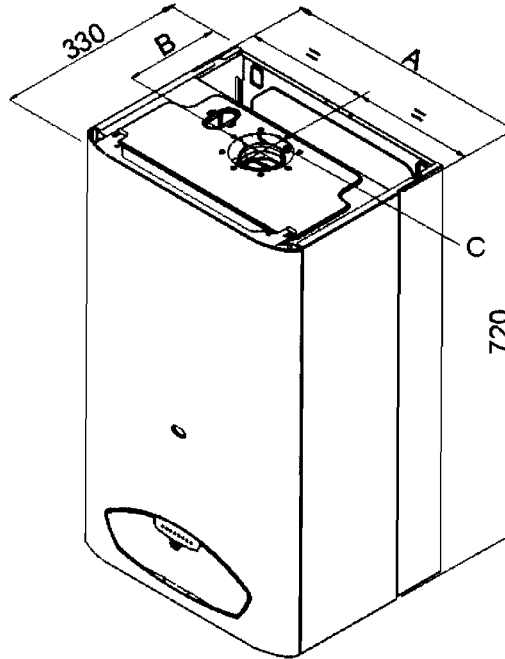
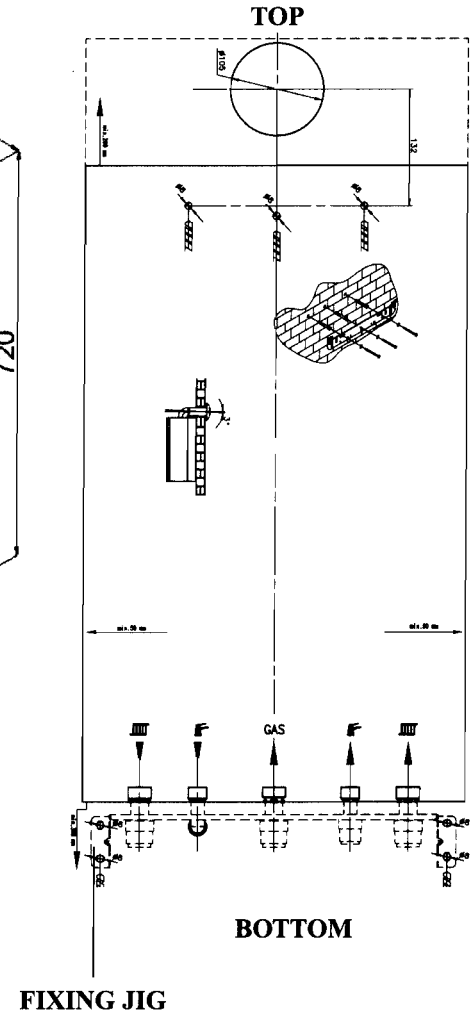

Figure 12



10.3 Position the supplied template on the wall, ensuring it is level both vertically and horizontally (*figure 12*). Mark the boiler fixing jig and wall bracket fixing positions and flue outlet position.

- ❑ For flue run to rear of boiler - Mark the flue centre position direct from template.
- ❑ For flue run to side of boiler - Mark the horizontal flue centre line on the rear wall. Extend the horizontal line to the side wall allowing a 3% decline towards the point of termination. Mark the flue centre vertical line. (*figure 13*.)

Figure 13.

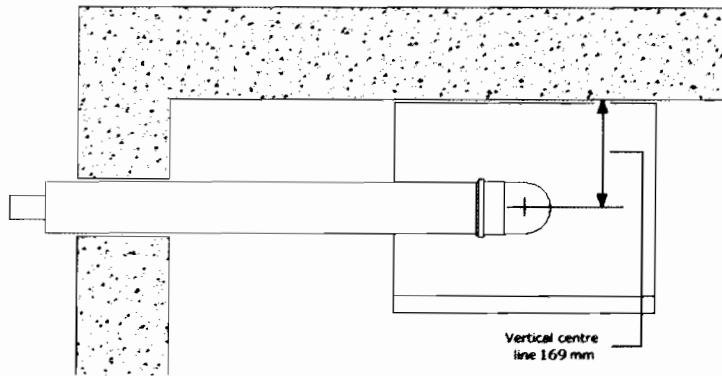

10.4 When cutting the flue hole it is recommended that a 105mm diameter core drill is used where both internal and external access for the flue installation is available. Where only internal access is available a 125mm diameter core drill should be used. (NB. Please take adequate precautions to prevent debris entering boiler via flue connection).

10.5 According to template, using an 8.5mm drill bit, drill the holes for fixing jig and hanging bracket. Locate and secure the supplied wall mounting bracket and fixing jig in position. (*figure 14*)

Figure 14.

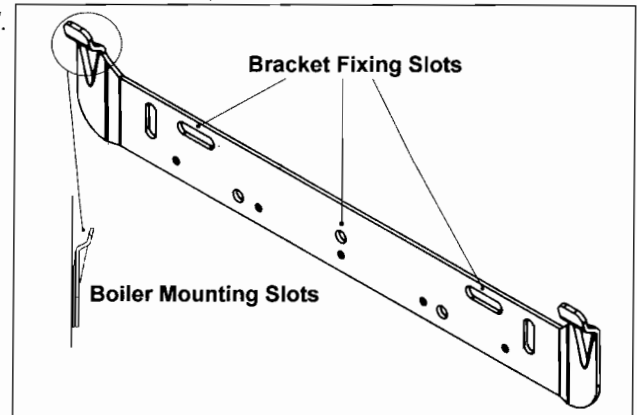

10.6 Mount the boiler onto the fixing bracket via the boiler mounting slots. Boiler's lift weight is 36 kg for S30 Compact and 35 kg for S24 Compact.

10.7 Connect isolation valves assembled on the fixing jig to boiler ensuring washers are fitted properly.

10.8 On installing the flue, determine the required length of the **outer air duct** by measuring the distance 'L' from the face of the external wall to the back of boiler's elbow connecting collar. The measurement for the **inner flue duct** will be 'L' + 20mm

10.9 Measuring from the back of the terminal connection, mark distance 'L' onto the outer air duct. (*figure 15*)

10.10 Cut the **outer air duct only** to the required length ensuring that the cut is square and free from burrs.

Figure 15

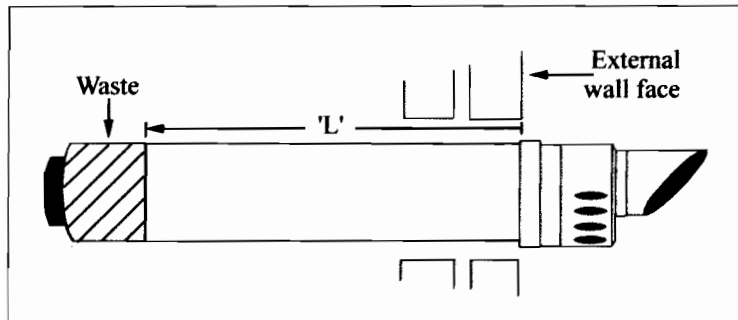

10.11 Measuring from the back of the terminal connection, mark distance 'L' + 20mm onto the inner flue duct and cut the duct to size, ensuring that the cut is square and free from burrs. (*figure 16*)

10.12 Pass the flue assembly through the wall and connect the assembly to the boiler, ensuring that both the air and flue duct joints are fully pushed home into the connecting elbow's collar.

10.13 With the flue and joints secured fit the flue trim to the external wall surface using a suitable mastic. **Note.** Where internal access only is available, the flue trim must be attached to the flue assembly prior to passing the assembly through the wall.

Figure 16

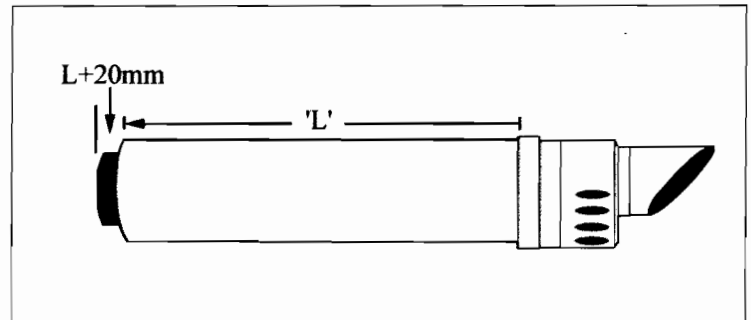

10.14 The vertical system diagram is shown in *figure 17*. Maximum flue length is 5 m for vertical and 4 m for horizontal. Remember that the diaphragm should be removed for flue length over 1 m.

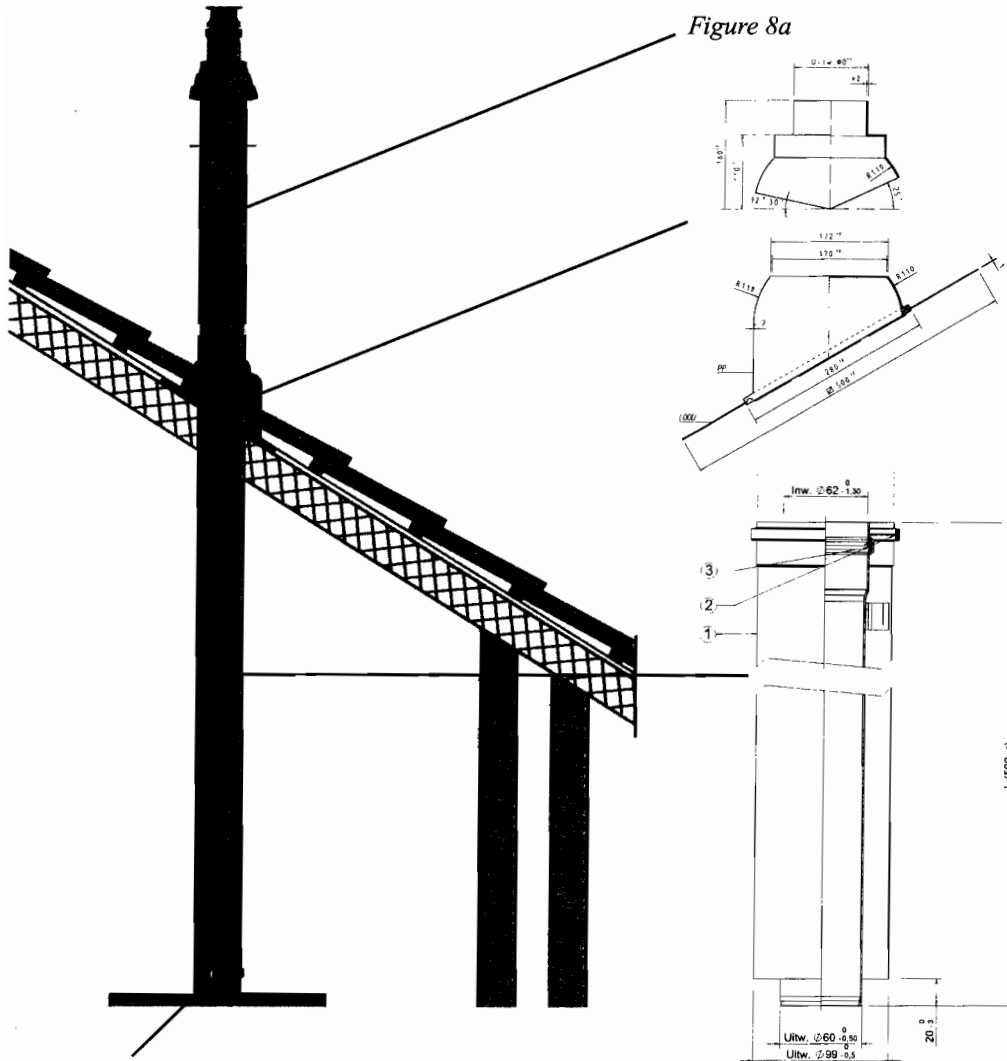

Figure 8a

Figure 8b

Figure 17

10.15 Provisions to fill the boiler and system must be made by the Installer, using an approved filling loop. The valves on fixing jig must be in accordance to water byelaws and fitted as close to the boiler as practicable.

10.16 Connect the domestic hot water, cold water inlet, heating system flow & return and pressure relief valve pipework to the supplied boiler fittings, ensuring that the pipework has been correctly flushed before final connection.

10.17 The electrical connections to the boiler must be in accordance to Section 9 of these instructions.

11. Gas Supply

- 11.1** The gas supply pipe must be capable of supplying the quantity of gas required by the boiler (see Technical Data section 2) in addition to the demand of any other gas appliances being serviced from that supply.
- 11.2** The internal diameter of the gas supply from the meter to the boiler's gas inlet connection must not be less than 22mm.
- 11.3** The meter governor must be capable of delivering a pressure of 20mbar for natural gas or 37mbar for propane gas.
- 11.4** On final connection of the gas supply to the boiler, the complete gas installation including the gas meter, must be tested for soundness and purged.

12. Filling the System

- 12.1** The S24/S30 Compact boiler must not be operated in a waterless condition.
- 12.2** On completion of the boiler installation and ensuring that all water connections are correctly made and tight the boiler may be filled with water by fitting a filling loop (not supplied with the boiler) and opening the two manual feed valves and boiler isolation valves.
- 12.3** Release the cover cap of the boiler's automatic air vent situated on top of the pump. (*figure 18*)

Figure 18

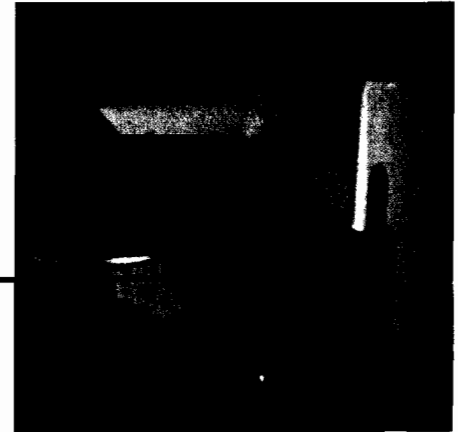

Release cover cap when filling system

- 12.4** The manual feed valves must be closed and the filling loop removed once the pressure gauge sited on the boiler's control panel, indicates a system pressure of 1.0bar.
- 12.5** Check that all the water connections throughout the system are sound and bleed each of the heating systems radiators in turn.
- 12.6** Air must be vented from the boiler's pump by unscrewing the pump's integral vent plug and allowing water to bleed for a few seconds taking care not to allow water to splash onto the electric parts.
- 12.7** Test the operation of the system's outlet safety valve by turning the valve knob anti-clockwise until water is released. Then the valve must be closed and re-set.

12.8 The system must be filled until the pressure gauge indicates a system pressure of 2.0 bar.

12.9 The water should be allowed to discharge by opening discharge valve until the system's designed operation pressure (nominally 1.5bar) is obtained, at which point the valve must be closed and re-set.

12.10 The moveable pointer on the control panel's pressure gauge must be set to coincide with the pressure indicating pointer to give a permanent record of the set system pressure.

Important Note.

In order to maintain the appliance warranty after initial filling the heating system must be thoroughly flushed using a propriety cleanser to remove foreign material and contaminants.

13. Control Panel Functions

Figure 19

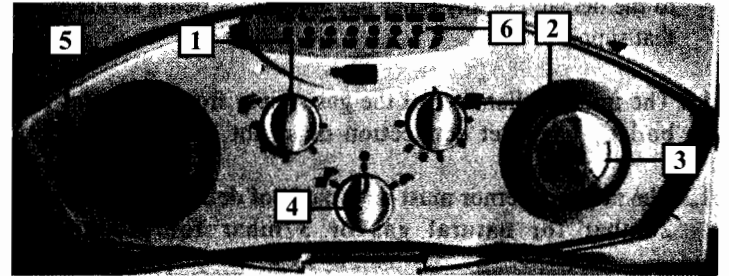

- | | |
|----------------------------------|--------------------|
| 1- D.H.W. temperature control | 4- Function switch |
| 2- C/heating temperature control | 5- Timer |
| 3- System pressure gauge | 6- LED. Display |

13.1 C/heating and D.H.W. temperature controls: The boiler's integral control unit monitors and adjusts both the boiler's hydraulic circuit and D.H.W. water outlet temperatures by means of sensors located on the C/heating and D.H.W. flow outlets. The sensors convert the water temperature into an electrical resistance that is relayed back to the control potentiometers located on the control panel. The respective potentiometer control dial allows manual setting of the maximum required temperature (reference value) being between 30° to 85°C for C/heating and 35° to 64°C for D.H.W. When the boiler functions in heating or D.H.W. mode, the resistance received is compared to the manually set reference value. The results of the comparison operates the modulation of the gas valve adjusting the useful heat output generated and stabilising the temperature to within $\pm 1^{\circ}\text{C}$

13.2 Re-set function: Should boiler lock out occur, please check gas supply, ionisation probe position and overheat safety thermostat reset button, the boiler may be restarted by switching to standby “O” position and switching back to its previous position once the fault has been eliminated. (See Page 42, figure 52)

13.3 Function switch: The three position switch allows the boilers operation to be set to 'Stand-by (centre position), 'Heating + D.H.W.' (left hand position) or 'D.H.W. only' (right hand position)

13.4 LED display: While giving the operational status of the boilers burner and water temperature, to aid in fault diagnostics the control unit has a built in facility that automatically indicates a fault status. If more than one fault simultaneously occurs, then only the highest priority fault is displayed. The green LED is lit unless the power supply is turned off. (figure 20)

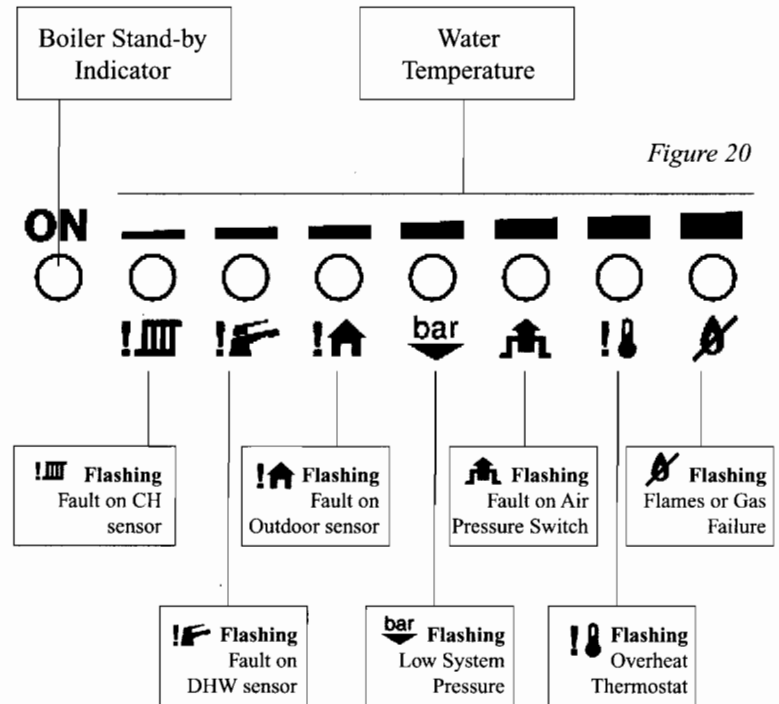

14. Commissioning

14.1 The S24/S30 Compact boiler has been tested and calibrated at the factory and is dispatched with its on board controls set to provide a maximum central heating and D.H.W. output of 24kW for S24 Compact and 30kW for S30 Compact. Consequently, once all the connections have been made and the boiler has been filled with water to the designed system operating pressure, the boiler may be fired prior to adjusting its on board parameters to match the heating systems requirements.

14.2 Prior to firing, check that the electrical supply to the boiler is 'On' (The green boiler 'Stand by' indicator will light) and the gas service cock is in the open position.

- ❑ Set the boiler's central heating and domestic hot water temperature controls to maximum by turning them fully clockwise.
- ❑ Set the external room thermostat (if fitted) to maximum and set thermostatic radiator valves to maximum.

14.3 Switch the boiler's function switch to the central heating and domestic hot water position. The boiler's control unit will now automatically carry out pre-ignition safety checks before igniting the burner.

14.4 On burner ignition check the integrity of the boiler's flue for soundness and correct operation.

14.5 Check the boiler for correct domestic hot water operation by opening and closing the household domestic hot water draw off taps.

14.6 In order to maintain the appliance warranty after initial filling the heating system must be thoroughly flushed using a propriety cleanser to remove foreign material and contaminants.

14.7 Restart the boiler and again allow the central heating system to reach maximum operating temperature. Check that all the water connections throughout the system are sound and bleed each of the heating systems radiators and purpose made air release points in turn.

14.8 Check the system pressure and top up if necessary.

14.9 Reset the central heating & domestic hot water temperature controls and room thermostat to the desired temperature settings.

Important Notice.

Failure to thoroughly flush the boiler and heating system or to add an anti corrosion inhibitor to the system water will invalidate the boiler's warranty.

15. Onboard Adjustments

15.1 The S24/S30 Compact boiler accommodates adjustments to its onboard settings via potentiometers and dip switches situated on the rear of the control panel. (*figure 21*)

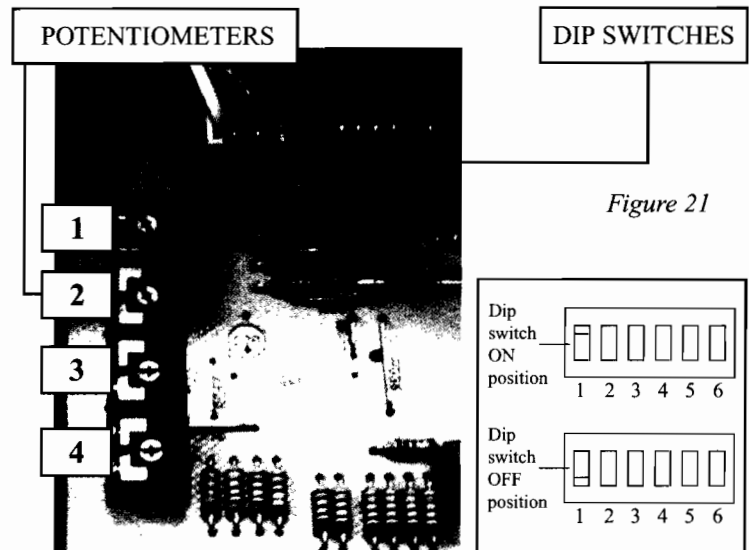

Figure 21

The potentiometers can be reached by removing the cover on the rear of control panel (*Figure 22*). But to reach the dip switches, the control panel must be opened.

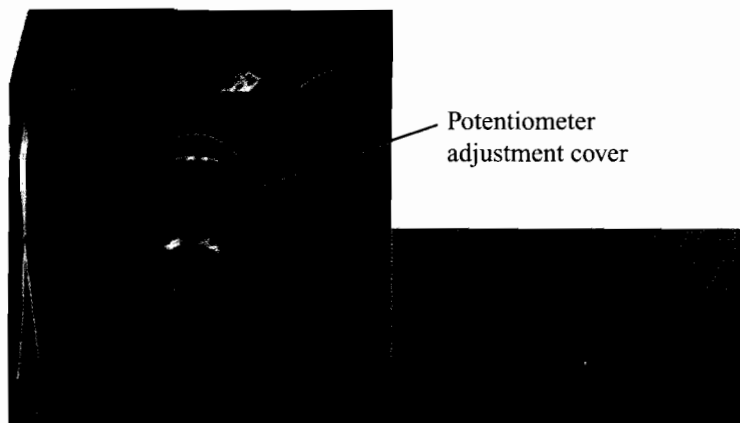

Figure 22

15.2 Setting the maximum c/heating flow temperature: The boiler is dispatched with a maximum flow temperature factory set to 90°C. Where a lower maximum temperature is required such as in the case of underfloor heating, the factory setting can be altered between a maximum of 50°C and a minimum of 30°C, by fitting dip switch '6' into ON position.

15.3 Setting the boiler's integral pump: The boiler's integral pump is factory set to operate in both central heating and D.H.W. mode. Where an external pump is incorporated into the system design the integral pump may be disconnected in central heating mode by fitting dip switch '5' into ON position.

15.4 Setting the 45 seconds delay: The boiler has a factory set to exclude delay of 45 seconds before re-ignition following closing a tap and CH mode start. This delay can be set to 45 seconds by fitting dip switch '3' into OFF position.

15.5 255 seconds delay setting: The boiler has a factory set of 1 minute (anti cycling time) before re-ignition following burner shut down on the primary hydraulic water reaching its set temperature. This delay can be increased up to 255 seconds by turning potentiometer 2 clockwise and can be decreased to 0 by turning anticlockwise.

15.6 Pump working mode setting: The boiler has a factory set to operate the pump for pre-purge and post-purge times by dip switch 2. Selecting 'ON' position of dip switch 2, pump works only when burner is turned on. When the burner is stopped, pump continues to work for 45 seconds then it is switched off. When selecting 'OFF' position of dip switch 2, pump works normal mode.

15.7 Setting the Heating output: The S24/S30 Compact is factory set to give a maximum c/heating output of 24kW for S24 Compact and 30kW for S30 Compact. The output can be adjusted to match the needs of the designed heating system by the potentiometer '3'. To re-set the boilers maximum c/heating heat output:

- Attach a pressure gauge to the boilers gas valves outlet test point (*figure 23*)
- With the boiler burner firing, adjust potentiometer '3' until the required burner pressure setting is obtained. (*see table 1*)

Figure 23

Burner Pressure test point



Gas inlet test point

Burner Pressure	Nominal Output	
S24 Compact		
1.6 mbar	9 kW	30729 Btu/h
3.9 mbar	14 kW	47802 Btu/h
7.2 mbar	19 kW	64874 Btu/h
12.7 mbar	24 kW	81946 Btu/h
S30 Compact		
1.7 mbar	10.1 kW	34485 Btu/h
3.25 mbar	14 kW	47802 Btu/h
7.3 mbar	21 kW	71464 Btu/h
15 mbar	30 kW	102454 Btu/h

Note. The maximum and minimum heat output for **domestic hot water** is pre-set on the gas valve. It is not necessary to make further adjustments.

15.7 Gas valve ignition capacity. The graduated opening of the gas valve for ignition rate is governed by the 4th potentiometer control, which is factory set. To assist in setting the boiler's modulating gas rate perimeters the ignition rate of the valve can be forced from minimum to maximum rate by setting the potentiometer clockwise.

Important.

Gas Type Jumper, Dip Switch 1, Dip Switch 4 and Dip Switch 5 are factory set and must not be adjusted.

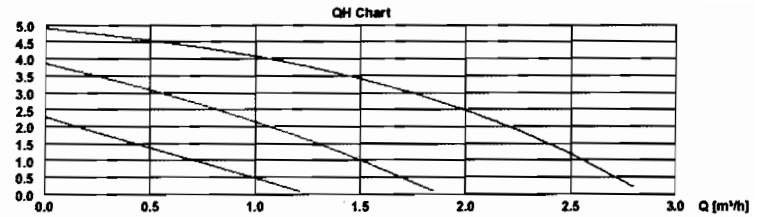

Figure 24

15.8 The boilers integral pump is factory set to its maximum speed setting to give a 1000 l/hr flow on a nominal 4m head. The pump may be adjusted to a lower speed to match the designed c/heating system requirements. (figure 24)

15.9 The potentiometer '1' is used to adjust 'K' factor of outdoor temperature sensor. For further information please read the manual which is given with your outdoor temperature sensor. (available as an accessory)

16. Safety Devices

16.1 An hydraulically operated primary pressure switch monitors for low pressure or water shortage in the primary hydraulic circuit and will switch the boiler off if the pressure is below 0.3 bar. Intervention by this switch will not allow the boiler to operate until the circuit has been re-pressurised up to between 1 to 2 bar.

16.2 The temperature of the water flowing from the primary heat exchanger is monitored by electrical serial connected overheat thermostats located on its outlet pipe. If the temperature control system of the boiler fails the sensor switch opens, cutting of the electrical supply to the gas valve and the boiler goes to 'Lock-out.' One of thermostats is self re-set, another one is manually re-set that on activation the thermostat has to be manually re-set via a dedicated reset button sited on the thermostat's body. When thermostats are re-set, the boiler has to be also manually re-set by turning the function switch to 'O' and back to its previous position.

16.3 An air pressure switch situated in the boiler's fan compartment monitors the boiler's flue operation. If a partial obstruction within the flue occurs the fan will continue operating but the boiler's burner will shut down until the blockage is cleared.

16.4 The boiler's control unit has in-built frost protection device that fires the boiler's burner when the temperature of primary hydraulic water falls below 6°C. The device works irrespective of any room thermostat setting and will protect the complete heating system. On reaching a water temperature of 15°C the boiler reverts back to normal operation.

16.5 If there is a fault on DHW sensor, system continues operation by controlling DHW outlet temperature by flow sensor and CH sensor which limits the temperature up to 64°C during DHW operation. If such failure occurs and displays on LED screen, please contact service department.

16.6 If the boiler does not operate in 24 hours and electrical supply to the boiler is on, pump will work for 30 seconds and three way valve motor will work 10 seconds. (Once passing to CH position and returning to DHW position) to prevent blockage.

16.7 After reaching CH temperature of 105°C, fan is kept working until CH temperature decreases to 100°C.

16.8 System is controlling CH temperature slope. When CH temperature slope is more than 5 °K/second or CH temperature ΔT (after burning off) more than 15 °K, system is closed. When decreasing CH temperature to 46°C, system is restarted.

17. Routine Servicing

17.1 To ensure the continued efficient and safe operation of the boiler it is recommended that it is checked and serviced at regular intervals. The servicing must be carried out by a competent person. The frequency of servicing will depend upon the particular installation conditions and usage, but in all cases the boiler must be serviced at least once a year.

17.2 Following servicing of the boiler the relevant sections of the 'Benchmark' Installation, Commissioning and Servicing Log Book must be completed.

17.3 Prior to servicing a check of the flue operation and terminal guard (if fitted) along with a preliminary check of the boilers operation must be undertaken.

17.4 Ensure that both the electrical and gas supplies to the boiler are isolated before commencing to service the boiler.

17.5 Remove the boiler casing as follows:

- Open the front panel by removing two screw at the bottom of the boiler. (Figure 25)

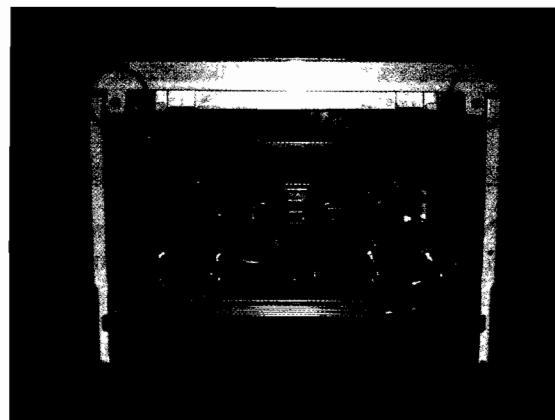

Figure 25

- ❑ Release the hermetic chamber cover by removing two screws on both sides and by lifting them to release from their retaining hooks. (*figure 26*)
- ❑ Release the side panels by removing the screws on the upper and lower sides. Remove the panels by moving on sides and up.

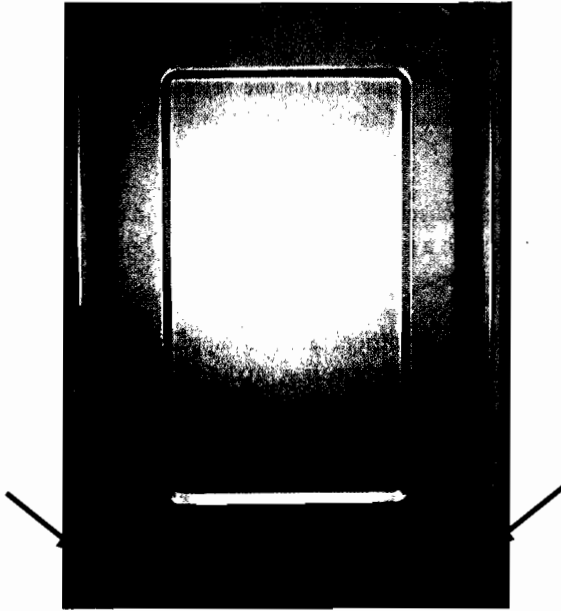

Figure 26

WARNING: DO NOT TOUCH the flame inspection window or its immediate surroundings.

- 17.6 Remove the combustion chamber cover by removing four screws on sides. (*figure 27*)

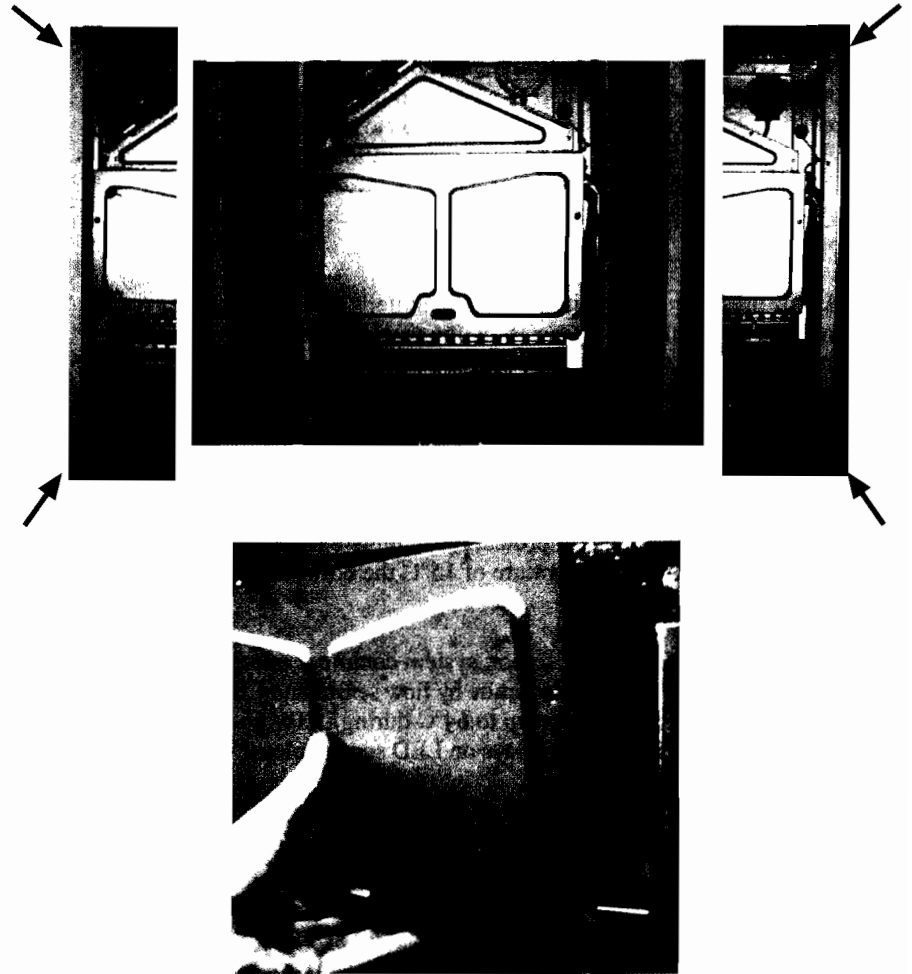

Figure 27

17.7 Disconnect the electrical leads and air pressure switch connection tube from fan, remove the screws of fan and withdraw fan from fan hood with 56° bend. (Figure 28)

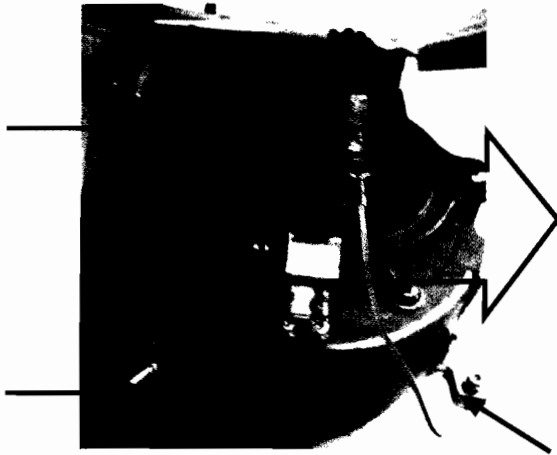

Figure 28

17.8 Remove the burner assembly from the combustion chamber as follows:

□ Pull off the ignition and flame electrode leads from PCB and remove the wires with gasket on hermetic chamber lower part. (Figure 29)



Figure 29

□ Remove burner retaining screws on sides and remove burner. (Figure 30)



Figure 30

Ignition electrodes

Ionisation electrode

Note. All washers/gaskets must be retained for use on re-assembly, unless damaged.

17.9 Visually check for debris/damage and clean or replace as necessary the following:

- ⇨ Heat exchanger
- ⇨ Burner
- ⇨ Fan/compartment
- ⇨ Electrodes
- ⇨ Insulation/gaskets

Important.

- ❖ Clean the heat exchanger using a soft brush or vacuum cleaner. Do not use any tool likely to damage painted finish of heat exchanger.
- ❖ Clean burner by washing in soapy water. Allow to dry thoroughly before re-fitting.
- ❖ Do not use wire or a sharp instrument to clean burner injectors.
- ❖ Ensure ignition electrode gap is set to 4 mm.

- ❑ Close the isolating valve on boiler's cold water inlet by turning the valve head full clockwise.
- ❑ Open one or more hot water taps to drain boiler circuit.
- ❑ Disconnect the cold water inlet connection to the boiler.
- ❑ Clean and inspect filter, replace if necessary as described in (18.19).
- ❑ Re-fit the filter and reinstate the cold water inlet connection to the boiler.
- ❑ Fully open the isolating valve on boiler's cold water inlet and check for leaks.

17.11 On completion of service reassemble the boiler components in reverse order to removal ensuring that all component joints and gaskets are sound. Any damaged gasket must be replaced.

17.12 Reinststate the boiler's electrical and gas supplies and check for gas soundness and correct boiler operation.

17.10 The boiler is fitted with a cold water inlet filter which must be inspected on each service. To gain access to the filter:

18. Component Replacement

Caution.

While no substances harmful to health are contained in the appliance, some components parts of the boiler (insulation pads, gaskets and rope seals) are manufactured from man made fibres. When damaged or broken these fibres can cause temporary irritation or rash to skin. High dust levels may irritate eyes and upper respiratory system. It is important therefore, that sensible precautions are applied when exchanging components.

18.1 Ensure that both the electrical and gas supplies to the boiler are isolated before commencing to replace any component part.

18.2 To prevent the need to drain the entire heating system when replacing the boiler's integral pump, expansion vessel, safety relief valve and pressure gauge, the boiler's hydraulic circuit may be isolated from the central heating circuit by closing the boilers isolation valves. Use purpose made drain off under the boiler, not the pressure relief valve. Opening the discharge valve will then drain the boiler's hydraulic circuit.

18.3 For replacement of the following components it will be necessary to remove the boiler casing panels as described in Section 17.

18.4 Domestic hot water sensor

- The domestic hot water sensor is located on the left of hydraulic kit's hot water side. (*figure 31*)
- Disconnect leads from sensor.
- Remove the sensor by using 13 spanner from kit.
- Fit replacement sensor ensuring washer is fitted properly.
- Fit leads to replacement sensor



Figure 31

18.5 Central heating sensor



Figure 32

- The c/heating sensor is located on left side of hermetic chamber on outlet of primary heat exchanger. (*Figure 32*)
- Unclip sensor from pipe.
- Disconnect leads from sensor.
- Fit replacement sensor.
- Fit leads to replacement sensor.

18.6 Fan Unit

- Remove electrical leads of fan.
- To remove the fan, remove 90° bend of flue kit and 56° bend on outlet of fan.
- Release the fan units fixing screws, air pressure switch connection tube and remove fan unit as described in 17.7.
- Fit replacement fan unit in reverse order and reconnect electrical leads.

WARNING. The fan unit must be correctly earthed, please ensure that the earth lead is connected.

18.7 Air pressure switch

- The air pressure switch is located on the top right-hand side of the fan unit chamber. (*figure 33*)
- Remove sensing tube and electrical connections from air pressure switch.
- Remove air pressure switch by pulling forward.
- Fit replacement switch to boiler in reverse order to removal, noting that the pressure sensing tube fits to the front connection on switch.



Figure 33

Air pressure switch

18.8 Burner

Note. The replacement burner is supplied in its component parts and requires assembly on site.

- Remove burner assembly from combustion chamber as detailed in **Section 17 (8)** retaining all washers/gaskets for use on re-assembly.
- Remove burner injectors as shown in *Figure 34*.
- Fit burner injectors to burner injector bar and tighten, ensuring that the injector size, marked on each injector is the same as stated in the '**Technical Data**' section for the type of gas being used.



Figure 34

- Fit burner (replace if necessary) and reassemble boiler.
- Check for gas soundness and boiler operation.

18.9 Printed circuit board (PCB)

- Turn off and isolate electrical supply.
- Remove radiation protection part by releasing the two fixing screws. (figure 35)
- Remove interface cover by lifting two latches. (figure 36)
- Remove the electrical connections to the PCB by pulling carefully.
- Release the screws securing the PCB to the control panel and lift out PCB.
- Fit replacement PCB in reverse order to removal, ensuring that the PCB electrical connections are fully pushed home.

- Set the on board adjustments to the same value as the old PCB.



Figure 35



Figure 36

18.10 Pump

- The order of removal is different between the failures in motor or in plastic body.

In case of motor failure:

- Drain the boiler's hydraulic circuit as detailed in (18.2).
- Disconnect the screws connecting pump motor to the body. (Figure 37)

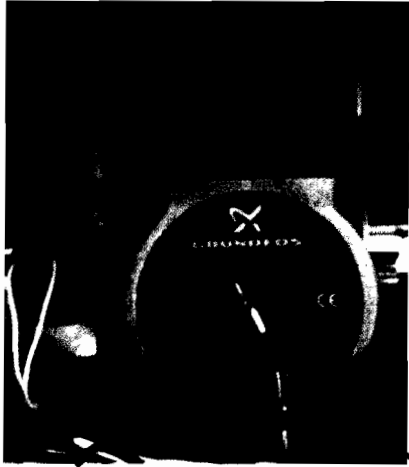

Figure 37

- Pull out the motor and disconnect electrical connection from cable box of pump. (Figure 38)

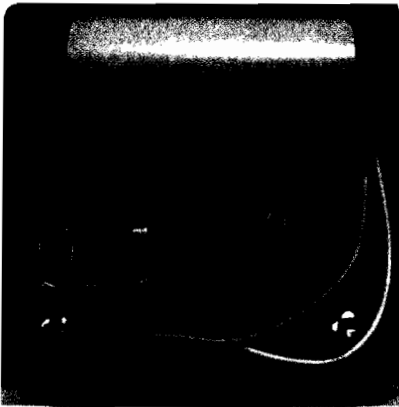

Figure 38

- Fit replacement motor in reverse order ensuring that the correct polarity of the electrical connections are observed.

- Open isolating valves on flow and return connections, refill, vent and re-pressurise system ensuring the pump union joints are sound.

In case of body damage:

- Remove motor as described above.
- Remove secondary heat exchanger as detailed in (18.12).
- Remove the expansion vessel pipe by removing clip on pump body.
- Remove the pressure gauge connection as detailed in (18.18).
- Disconnect electrical leads of low pressure sensor as detailed in (18.11).
- Disconnect the pumps outlet fitting. (Figure 39)



Figure 39

- Remove the fixing screws of pump and hydraulic kit right part at the bottom of the boiler (Figure 40).

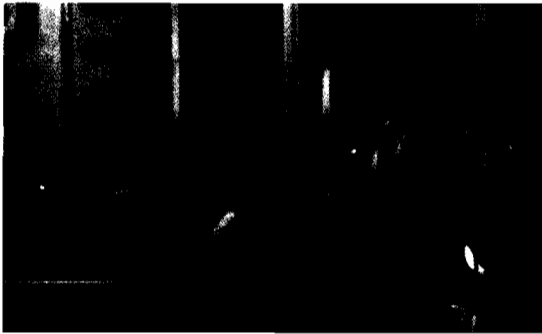

Figure 40

- Remove pump body together with the kit part.
- Remove pump body from the hydraulic kit by removing clip.
- Fit replacement body in reverse order ensuring that the pump washers are fitted and correct polarity of the electrical connections are observed.
- Open isolating valves on flow and return connections, refill, vent and re-pressurise system ensuring the pump union joints are sound.

18.11 Low water pressure sensor

- Drain the boiler's hydraulic circuit as detailed in (18.2).
- Locate system pressure sensor at front right handside of boiler and remove electrical sensors connections. (*figure 41*)

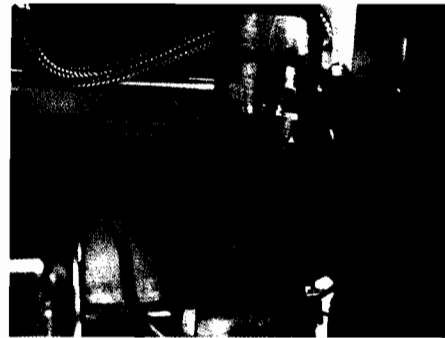

Figure 41

- Remove pressure sensor by turning it in an anticlockwise direction.
- Fit replacement sensor in reverse order of removal ensuring all washers are fitted.
- Open isolating valves on flow and return connections, refill, vent and re-pressurise system ensuring the pump union joints are sound.

18.12 Secondary Heat Exchanger

- Drain the boiler's hydraulic circuit as detailed in (18.2)
- Remove the two screws which connects heat exchanger to hydraulic kit. (*Figure 42*)



Figure 42

- ❑ Remove exchanger from the gap on the left hand side. (Figure 43)



Figure 43

- ❑ Fit new heat exchanger and reassemble boiler in reverse order ensuring all washers are fitted.

- ❑ Open isolating valves on flow and return connections, refill, vent and re-pressurise system ensuring the all joints are sound.

18.13 Primary Heat Exchanger

- ❑ Drain the boiler's hydraulic circuit as detailed in (18.2)
- ❑ Remove pipe clips on the pipes of heat exchanger.
- ❑ Release union connections on the pump and hydraulic kit, retaining washers for re-assembly.
- ❑ Remove CH sensor on exchanger return pipe.
- ❑ Remove pump-exchanger and exchanger-three way valve connection pipes. Figure 44

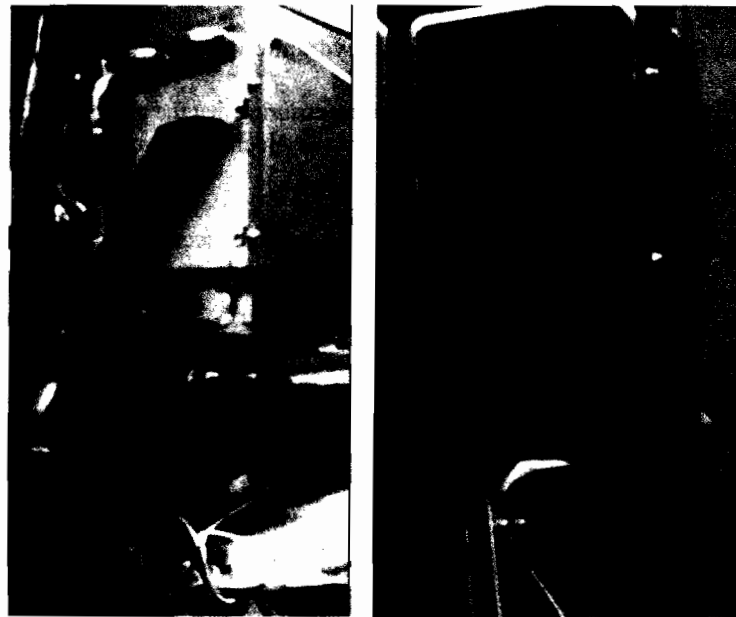

Figure 44

- Remove combustion chamber cover.
- Remove the heat exchanger by pulling forward.
- Fit new heat exchanger and reassemble boiler in reverse order ensuring all washers are fitted.
- Open isolating valves on flow and return connections, refill, vent and re-pressurise system ensuring the all joints are sound.

18.14 Gas valve

- Ensure that gas supply to boiler is turned off.
- Disconnect the electrical connections to gas valve modulating coil.
- Release the main gas supply tube connection from gas valve and manifold inlet, retaining the washers for use on reassembly.



Figure 45

- Release the main gas connection between the gas valve supply tube and gas inlet valve, retaining the washer for use on reassembly.
- Remove the gas valve's two securing screws and washers from the bottom side of boiler. (Figure 46)



Figure 46

- Rotate the gas pipe and withdraw gas valve assembly.
- Using the old gas valve as a guide, transfer old connections to replacement gas valve.
- Refit in reverse order to removal, the polarity of the wires to the modulating coil is not important.
- Check for gas soundness and correct boiler operation.
- Following replacement the maximum and minimum settings must be checked to ensure they are 15 mbar and 1.7 mbar for S30 Compact and 12.7 mbar and 1.6 mbar for S24 Compact respectively.

- ❑ Where necessary the gas valve settings may be re-calibrated by the following method:

18.14.1 Minimum setting (1.6 mbar for S24 - 1.7 mbar for S30)

- ❑ Remove one lead from the modulating gas valve coil. (*Figure 47*)
- ❑ Connect a suitable pressure gauge to the pressure outlet on valve
- ❑ Turn the boiler's function switch to the 'Winter' position.
- ❑ Turn the central heating temperature control to maximum setting.
- ❑ Remove the protective cover from the gas valve adjuster.
- ❑ Turn inner part by a plain screwdriver, **clockwise**: to increase the pressure setting, **anticlockwise**: to decrease the pressure setting. (*figure 48*)
- ❑ After adjustment, connect electrical connector and protective cover.

18.14.2 Maximum setting (12.7 mbar for S24 - 15 mbar for S30)

- ❑ Remove the protective cover from the gas valve adjuster.
- ❑ Push the ball inside the modulating gas valve coil using a sharp pointed tool. (*figure 49*)
- ❑ Turn outer part by a 10 size spanner (keeping the tool pushed) **clockwise**: to increase the pressure setting, **anticlockwise**: to decrease the pressure setting.
- ❑ After adjustment, refit the cover to the gas valve adjuster.



Figure 47



Figure 48



Figure 49

18.15 Expansion vessel

- Drain the boiler's hydraulic circuit as detailed in (18.2).
- Disconnect pipe coupling on expansion vessel.
- Release and remove nut securing expansion vessel to the boiler.



Figure 50

- Remove side panels.
- Lift vessel out of boiler from the gap over the chasis and fit replacement vessel to boiler in reverse order to removal, ensuring that sealing washer is fitted to pipe connection before tightening. (Figure 51)

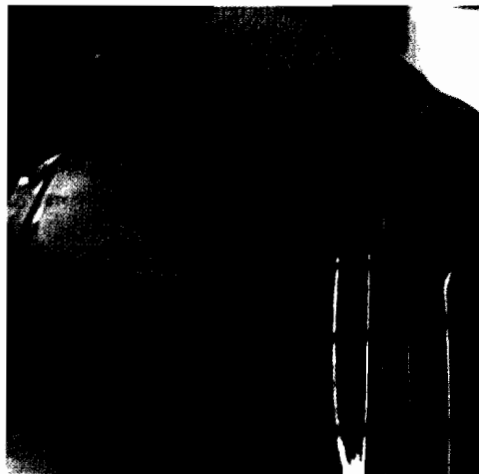

Figure 51

- Using a pressure gauge, ensure that expansion vessel charge pressure is 0.5bar (7.5psi)
- Open isolating valves on flow and return connections, refill, vent and pressurise boiler ensuring all joints are sound.

18.16 Overheat safety thermostats

- Remove front panel, hermetic chamber cover and right side panel.
- Locate one of overheat safety thermostat at front left hand side of boiler and another one is on right hand side of the primary heat exchanger.
- Disconnect electrical connection from thermostat.
- Unclip thermostat from pipe. Fit replacement thermostat in reverse order to removal.



Figure 52.1



Figure 52.2

18.17 Pressure relief valve.

- Drain the boiler's hydraulic circuit as detailed in (18.2).
- Disconnect discharge pipe on outlet of safety valve.
- Remove safety valve from hydraulic kit and retain o-ring for use on reassembly. (Figure 53)
- Fit replacement safety valve in reverse order to removal and refill, vent and pressurise boiler ensuring all joints are sound.



Figure 53

18.18 Pressure gauge

- Disconnect and remove capillary tube from the hydroblock. (figure 54)
- Remove the interface panel as described in 18.9.
- Remove the pressure gauge unit from the interface panel. (figure 55)
- Fit replacement pressure gauge in reverse order ensuring the gasket is in place.

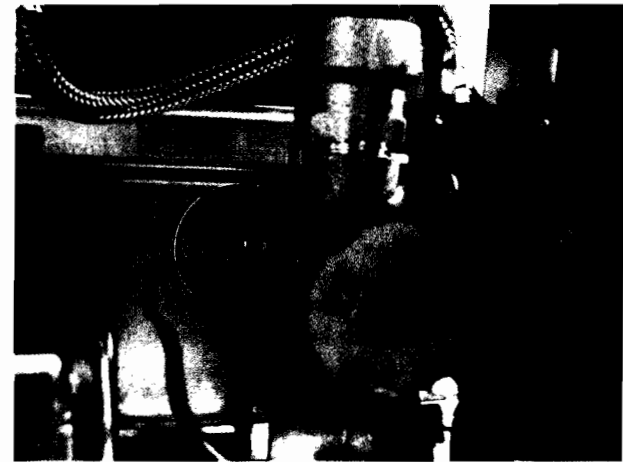

Figure 54

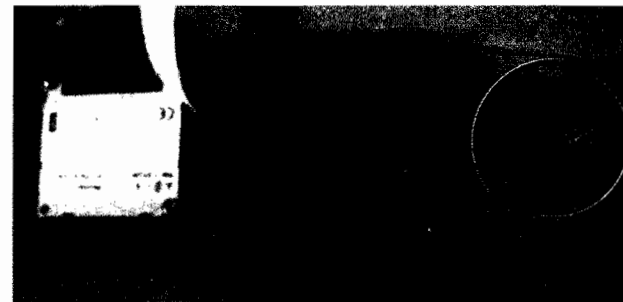

Figure 55

18.19 Hydroblock

- ❑ Drain the boiler's hydraulic circuit as detailed in (18.2).
- ❑ Remove secondary heat exchanger as described in (18.12)
- ❑ Remove pump (motor and body with right part of hydroblock) as detailed in (18.10)
- ❑ Remove right part of hydroblock from pump by releasing the clip.
- ❑ Release exchanger outlet pipe nut and rotate the pipe for easy removal of hydroblock left part.
- ❑ Disconnect the three way valve motor electrical connection and remove motor by releasing clip as described in (18.22)
- ❑ Release the nut connecting CH outlet connection to hydroblock.



Figure 56

- ❑ Disconnect DHW sensor as described in (18.4).
- ❑ Remove the screw securing left part of hydroblock to combination boiler.

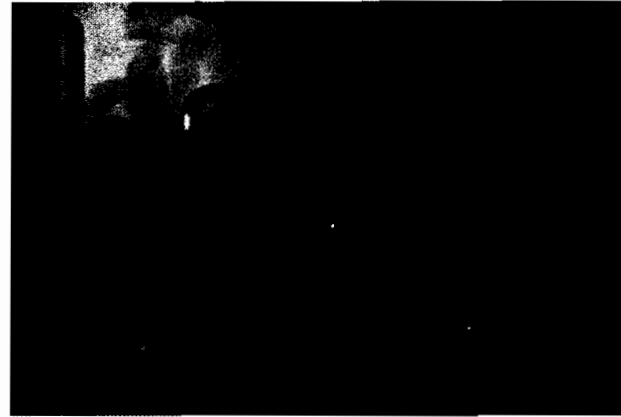

Figure 57

- ❑ Fit replacement hydroblock parts in reverse order to removal ensuring all other components are fitted properly.

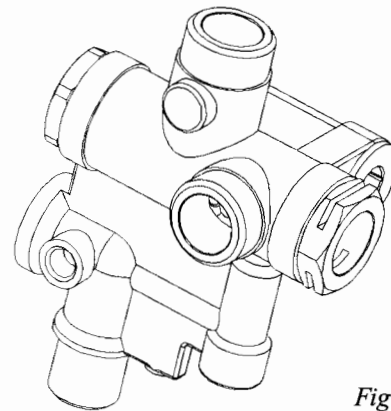
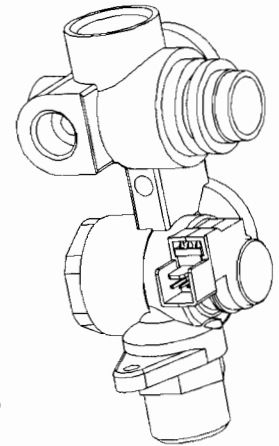

Figure 58



- ❑ Open isolating valves on flow and return connections, refill, vent and pressurise boiler ensuring all joints are sound.

18.20 Filter.

- Drain the boiler's hydraulic circuit as detailed in (18.2).
- Remove right part of hydroblock as described in (18.10).
- Remove the filter on the inlet of hydroblock.
- Clean or fit replacement filter.
- Fit parts in reverse order to removal ensuring all other components are fitted properly.
- Open isolating valves on flow and return connections, refill, vent and pressurise boiler ensuring all joints are sound.

18.21 Flow sensor

- Remove the flow sensor by using pliers.



Figure 59

- Fit replacement sensor in reverse order to removal.

18.22 Three way valve

- Ensure that the electric supply to boiler is OFF.
- Remove the electrical connection of valve.



Figure 60

- Remove the clips connecting valve to hydroblock.



Figure 61

- Fit replacement valve in reverse order ensuring the valve is fitted properly.

19. Gas Type Conversion

Warning

Gas conversion must be carried out by a competent person.

19.1. If gas type conversion is demanded (from NG to LPG etc.), follow these steps:

- The burner must be removed to reach injector bar as described in 18.8.
- Remove the old injectors from burner injector bar.
- Fit burner injectors to burner injector bar and tighten, ensuring that the injector size, marked on each injector is the same as stated in the '**Technical Data**' section for the type of gas that will be used.
- Fit burner (replace if necessary) and reassemble boiler.
- Check for gas soundness
- Change the position of Gas Type Jumper on main PCB:

- 1-2 for LPG
- 2-3 for Natural Gas
- Adjust the minimum and maximum burner pressures as described in 18.14.1 and 18.14.2.
- Check for correct boiler operation.

Important.

Gas type conversion must be stated by attaching the label, that is included in the gas conversion kit, on the boiler's data plate

Chart I Check electrical supply – C.H. sensor and frost protection

Check the following carefully before starting

- Gas supply is on, adequate and purged.
- Electric supply is on.
- Polarity is correct.
- CH system pressure is between 1 and 2 bar.
- Pump spins freely.

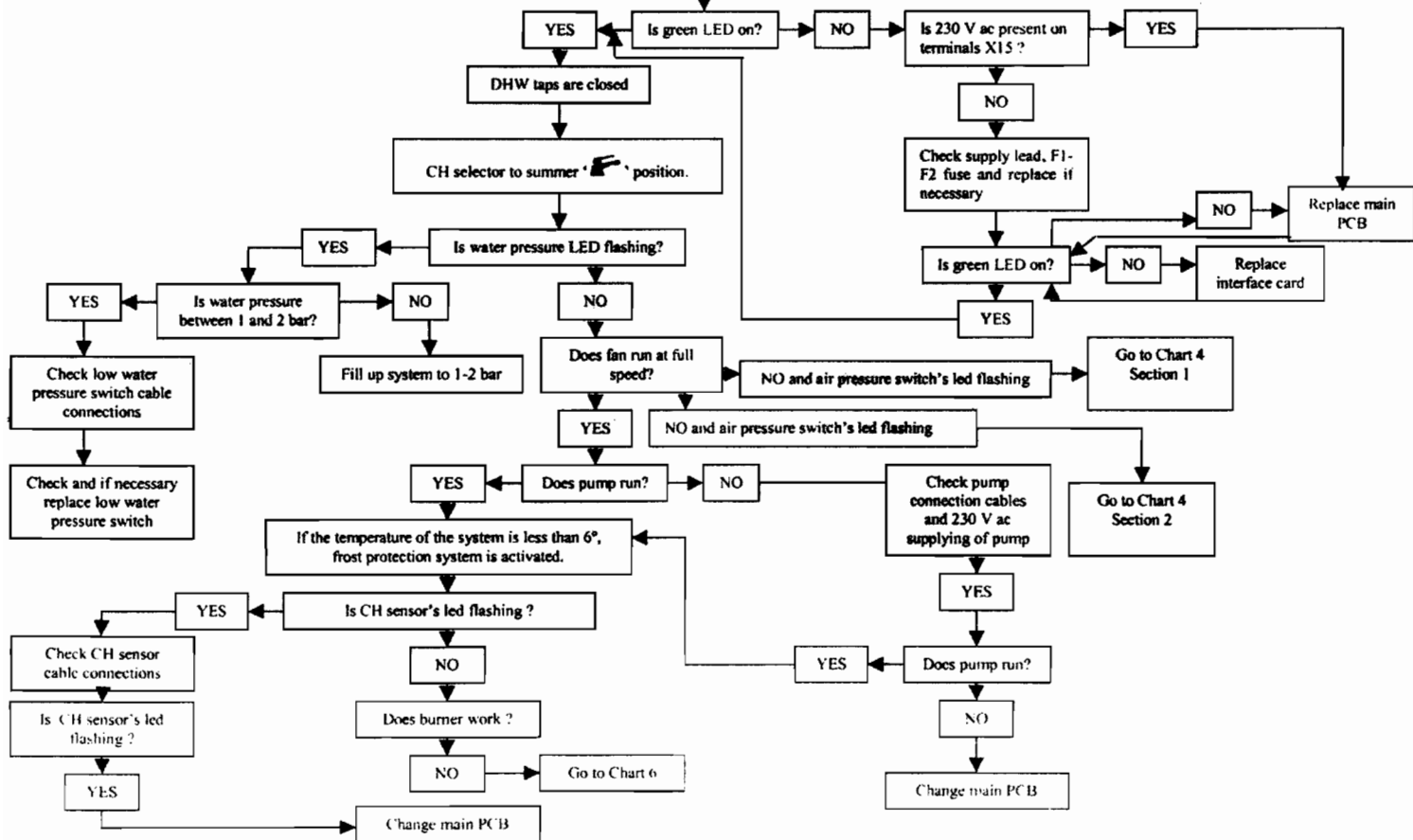

Chart II Check Domestic Hot Water Operation

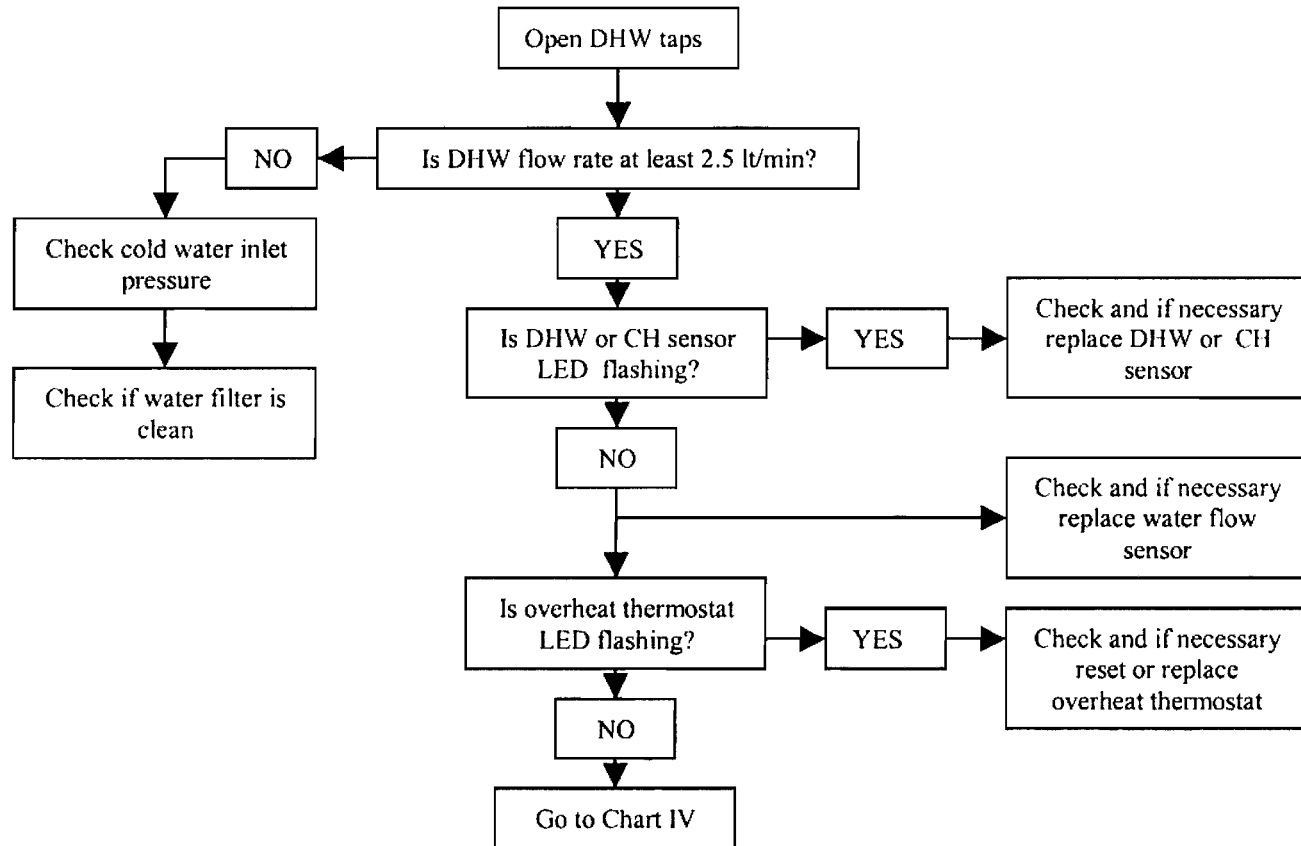

Chart III Check Central Heating Operation

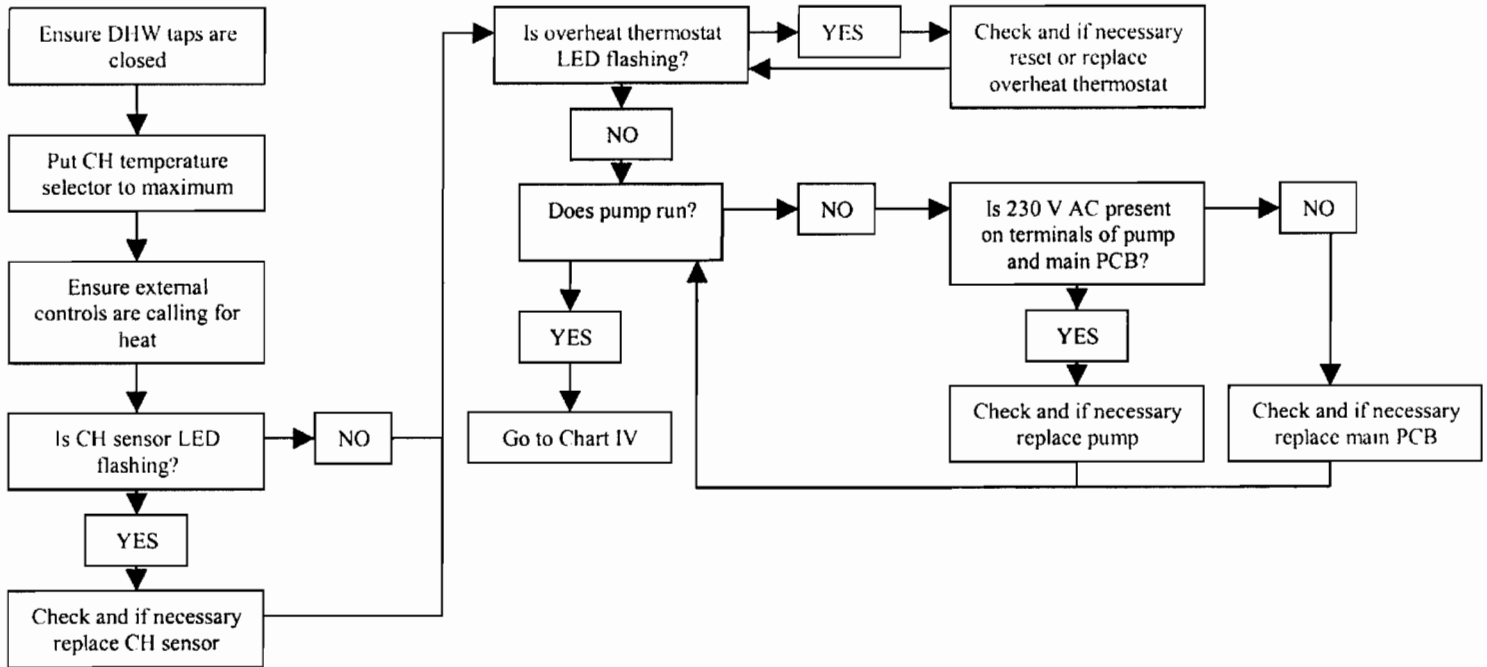

Chart IV Check Domestic Hot Water Operation

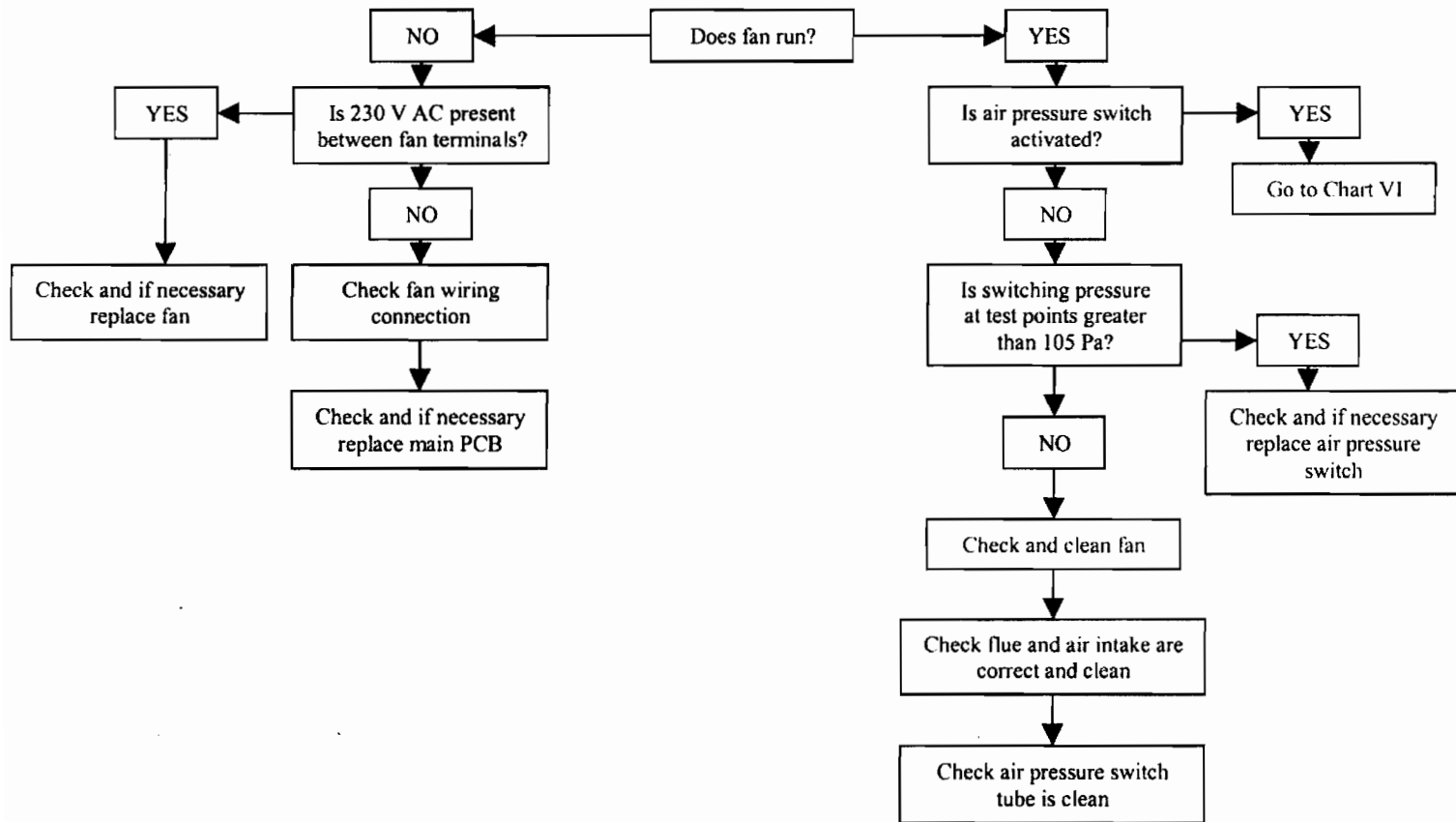

Chart V Check DHW and CH modulation

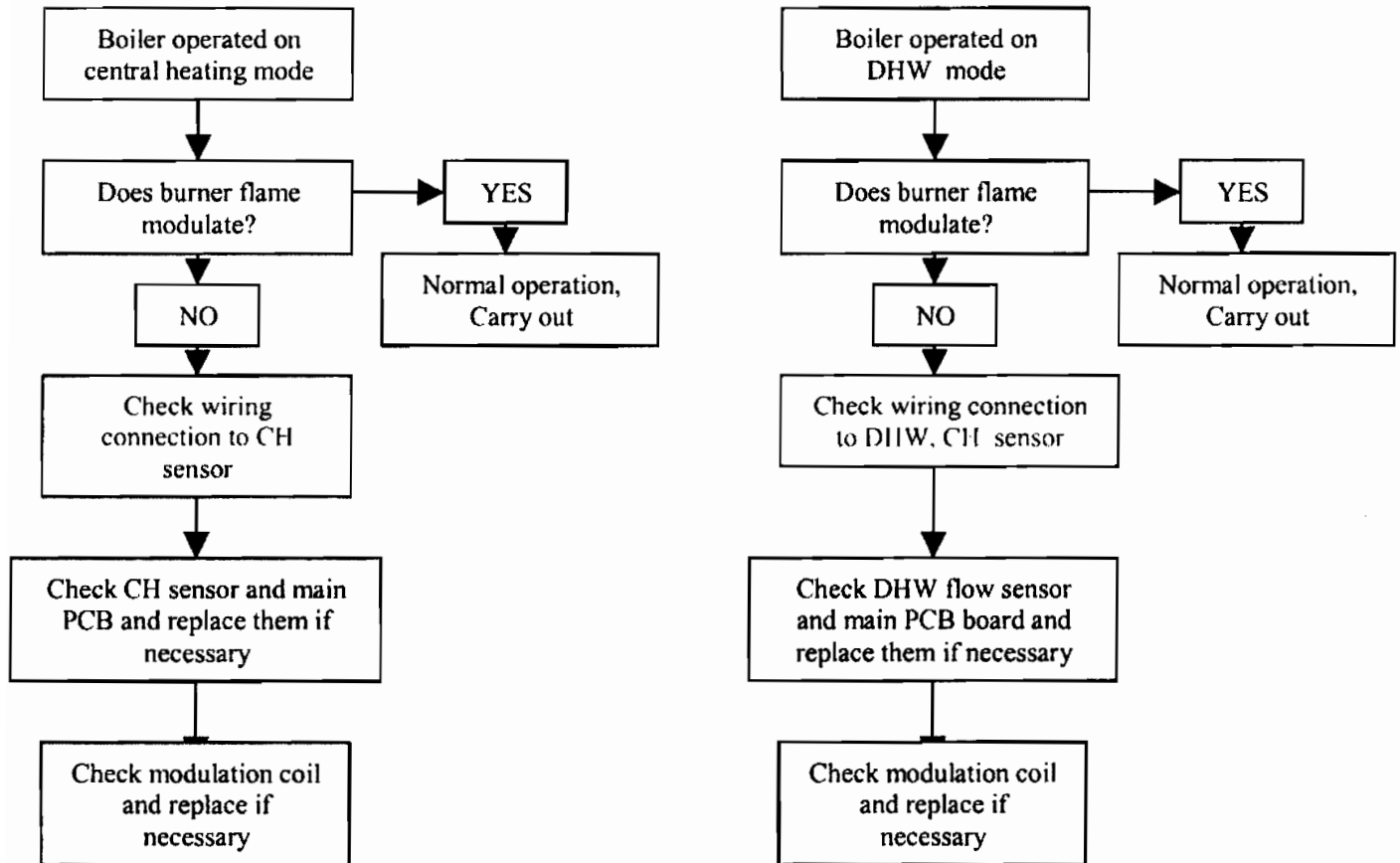
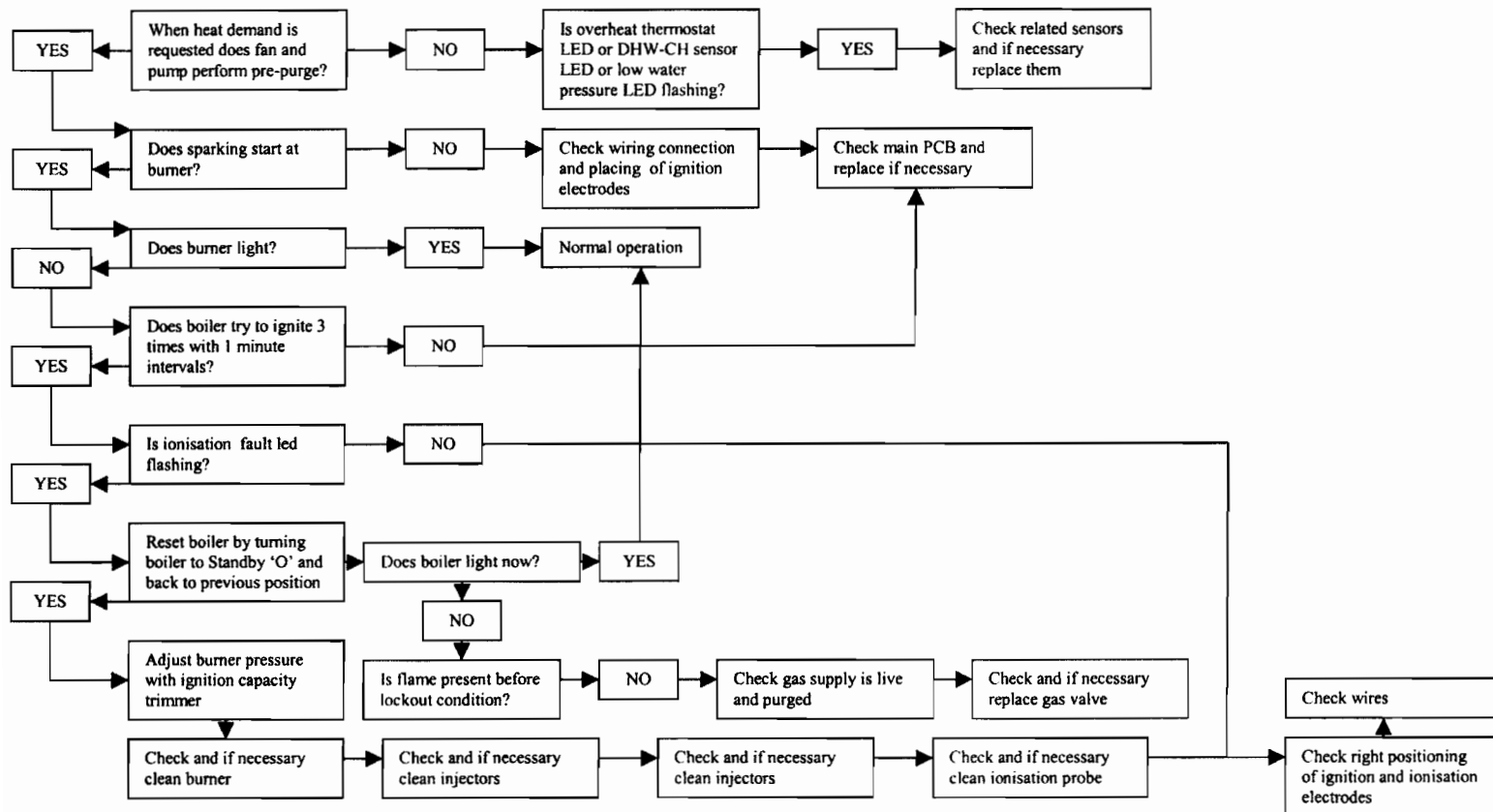

Chart VI Check Ignition System



Appendix 1 Spare Parts

PART No.	DESCRIPTION	ORDER CODE
1	HYDROBLOCK - THREE WAY VALVE PART	3003200017
2	HYDROBLOCK - PUMP PART	3003200018
3	LOW WATER PRESSURE SWITCH	3003200038
4	SAFETY VALVE	3003200019
5	PUMP	3003200022
6	EXPANSION VESSEL	3003200028
7	GAS VALVE	3003200006
8	BURNER - 30 kW	3001010003
9	BURNER - 24 kW	3001010002
10	COLLECTOR - 30 kW - NG	3001030003
11	COLLECTOR - 24 kW - NG	3001030002
12	PRIMARY HEAT EXCHANGER - 30 kW	3001020002
13	PRIMARY HEAT EXCHANGER - 24 kW	3001020001
14	CONTROL PANEL	3003200178
15	COVER	3003200180
16	PCB COVER	3003200084
17	ELECTRONIC CONTROL CARD	3003200328
18	INTERFACE CARD	3003200183
19	SECONDARY HEAT EXCHANGER - 30 kW	3003200027
20	SECONDARY HEAT EXCHANGER - 24 kW	3003200026
21	DHW SENSOR (NTC)	3003200031
22	CH SENSOR (NTC)	3003200152
23	WATER PRESSURE GAUGE	3004090673
24	CABLE GROUP	3003200112
25	MAIN FLY LEAD	3003200327
26	OVERHEAT SAFETY VALVE	3002185050
27	IGNITION ELECTRODES (RIGHT / LEFT)	3003200033 / 34
28	FLAME SENSE ELECTRODE	3003200035
29	FAN	3003200020
30	AIR PRESSURE SWITCH - 30 kW	3003200136
31	AIR PRESSURE SWITCH - 24 kW	3003200032
32	FRONT PANEL - 30 kW	3003200177
33	FRONT PANEL - 24 kW	3003200176
34	THREE WAY VALVE MOTOR	3003200039

APPENDICES

HEATTM LINE

S24/S30 COMPACT Wall Mounted Combination Boiler

User Instructions

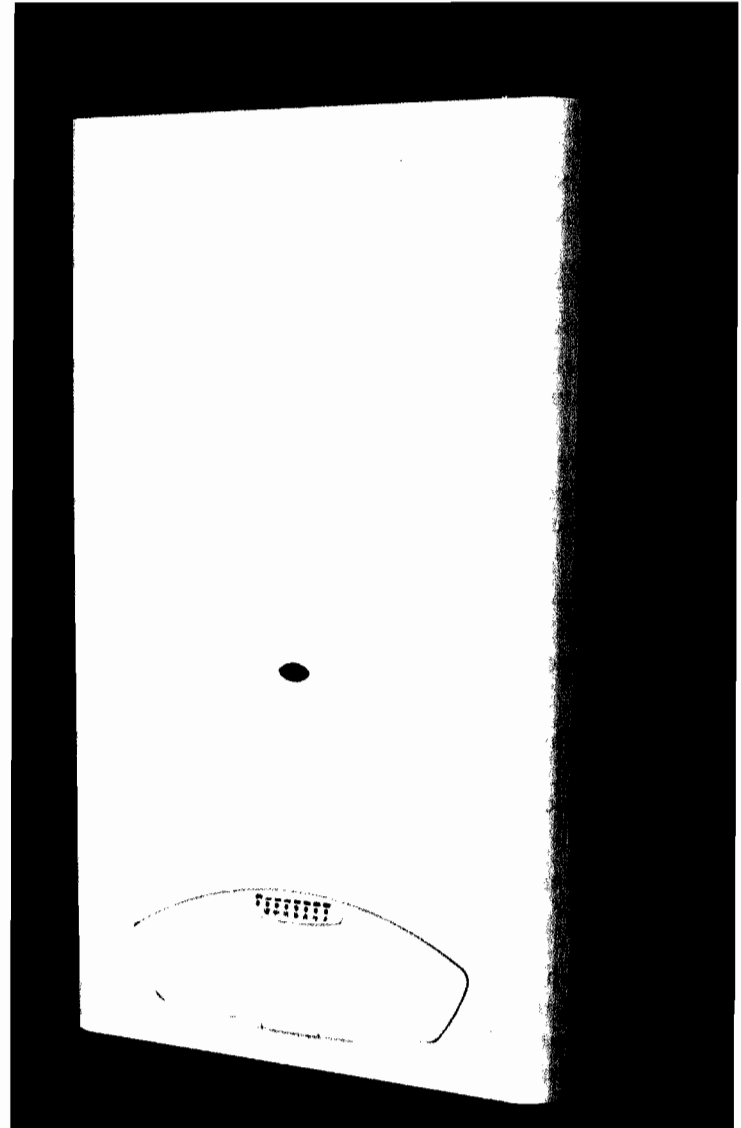

Natural Gas

Heat Line™ S24/S30 Compact Combi

British Gas Service Listing
S24 Compact G.C.N° 47-157-02
S30 Compact G.C.N° 47-157-03

The Heat Line™ range of heating boilers are manufactured from high quality materials, enabling reliability and optimum performance.

Heat Line™ are committed to the continual development of their appliances to ensure their customers benefit from the latest advances in combustion technology and energy savings.



Type test for purpose of Regulation 5 certified by:

Notified Body Gastec **CE 0694** PIN NO: 0694BO4118

Product/Production certified by:

Notified Body Gastec **CE 0694** PIN NO: 0694BO4118

The manufacturer, in the continuous process to improve his products, reserves the right to modify the data expressed in the present documentation at any time and without prior notice. The present documentation is an informative support and it cannot be considered as a contract towards third parties.

'Benchmark' Log Book

As part of the industry-wide initiative the S24/S30 Compact comes complete with an Installation, Commissioning and Service Record Log Book. Please read the Log book carefully and complete all sections relevant to the appliance and installation. The details within the Log Book will be required in the event of any warranty work.

On completion the Log Book must be left with the end user and the relevant sections completed on each subsequent Service visit.

IMPORTANT INFORMATION.

The Heat Line™ S24/S30 Compact is a high efficiency gas fired boiler and represents the highest level of technology found in today's gas boiler market.

In order to maintain peak efficiency along with optimum performance and reliability it is essential that the boiler be serviced annually by a competent person such as a CORGI Registered Engineer.

All C.O.R.G.I. Registered Installers carry a C.O.R.G.I. ID card and have a registration number, which should be recorded and entered on your benchmark log book. You can check your Installer registration by contacting C.O.R.G.I. on 01256 372300

The boiler's '**Log Book**' must be completed at each Service visit.

GAS SAFETY (INSTALLATION AND USE) REGULATIONS 1994

It is a legal requirement that all gas appliances must be installed and serviced by a competent or C.O.R.G.I. registered person in accordance with the above regulations. Failure to install or service gas appliances correctly could lead to prosecution. It is in your interest and that of safety to ensure compliance with the law.

For electrical safety the boiler must be earthed and protected by a **3.15-amp fuse**.

Note. In the event of a fault the appliance should not be used until a competent person has corrected the fault.

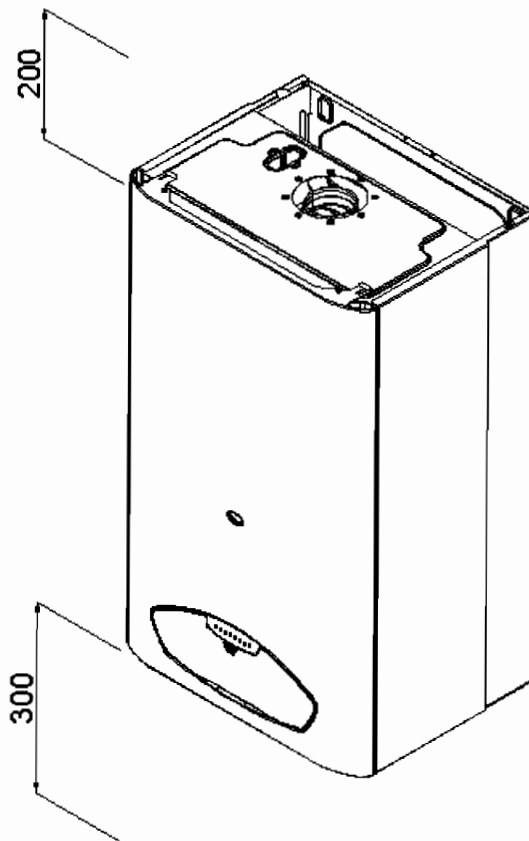

VENTILATION.

For maintenance and safety purposes, the boiler has been installed with a minimum space of 200mm above, 300mm below, 600mm to the front and 50mm to either side of the boiler case. It is essential that this space is not restricted by the addition of shelves etc. fitted above or below the boiler, or to the boiler sides.

GENERAL DESCRIPTION OF BOILER

The S24/S30 Compact is a combined domestic hot water and central heating appliance. Its internal control unit electronically provides direct burner ignition and combustion supervision along with continuous modulation of the burner's gas supply.

By means of a manual switch the S24/S30 Compact can be set to operate in one of two operating modes, domestic hot water only or domestic hot water and central heating.

DOMESTIC HOT WATER MODE:

When hot water demand is requested the boiler will fire automatically. An integral pump is then energised and hot water from the boiler's primary circuit is circulated through the secondary heat exchanger, allowing the instantaneous transferral of heat to the incoming cold water. The secondary heat exchanger is protected against an internal build up of lime scale by limiting the hot water temperature at the tap to a maximum 64°C. Hot water will continue to flow through the tap until no longer required. When the demand for hot water ceases the integral pump may continue to run for a short while to dissipate any excess heat within the boiler.

DOMESTIC HOT WATER AND CENTRAL HEATING MODE:

When heating demand is requested the boiler will fire automatically. An integral pump is then energised and hot water from the boiler's primary circuit is circulated around the heating systems pipework and radiators. The heat output from the boiler is automatically adjusted by the boiler's internal control unit to match the heating demand. As the water temperature of the heating system increases the gas input to the burner decreases, conserving energy and increasing efficiency. When the demand for heating no longer exists the burner will shut down and the boiler will revert to stand-by, waiting to respond to the next heating demand. The integral pump may continue to run after shut down for a short while to dissipate any excess heat within the boiler.

Please Note. When domestic hot water is called for during the heating mode, the boiler will automatically revert to domestic hot water mode until the demand for hot water ceases.

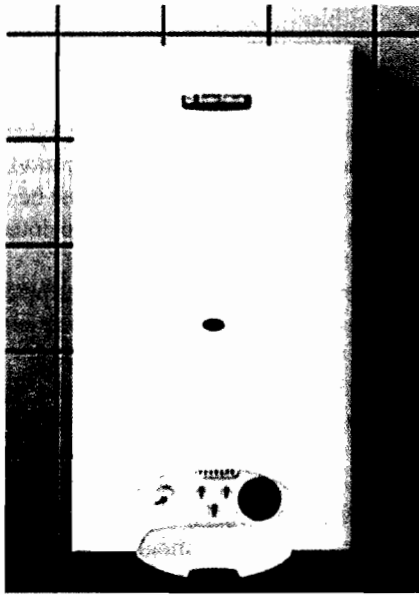

ACCESS TO THE BOILER CONTROLS.

The S24/S30 Compact boiler controls are found behind the control panel door, sited at the bottom of the boiler's front case. To open: press the doors retaining push catch. (fig.2)

Fig 2

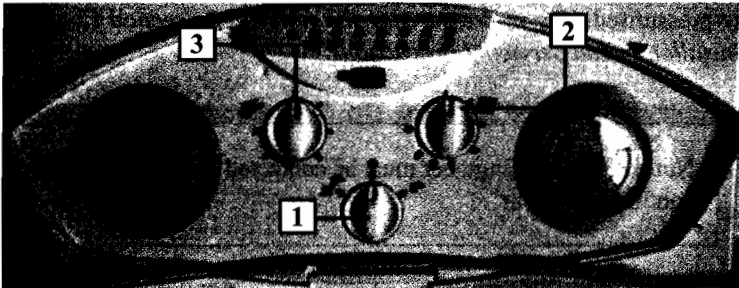







Fig 3

BOILER CONTROLS

The function and operation of the main controls located on the control panel fascia (fig.3) is as follows:

1. **(Function switch.)** This is the boiler's main operating switch. In the  position the boiler is in stand-by mode and power supply is ON. For the boiler to operate the switch must be in the  or  position.

When switched to the  position the boiler will operate only to supply domestic hot water. (Summer use) For the boiler to operate to give both central heating and domestic hot water the switch must be in the  position. (Winter use)

2. **(Central Heating temperature control.)** The position of this control dial will determine the temperature of the water delivered to the radiators. The water temperature can be set from a minimum of 30°C (anticlockwise stop position) to a maximum of 85°C (clockwise stop position.) When the knob shows  position, then the boiler works at 70°C providing the economic usage.
3. **(D.H.W. temperature control)** The position of this control dial will determine the temperature of the domestic hot water delivered to the taps or shower unit. The water temperature can be set from a minimum of 35° C (anticlockwise stop position) to a maximum of 64°C (clockwise stop position.) When the knob is at the beginning of black line, the water temperature is about 55°C providing the economic usage and minimum build up scale.

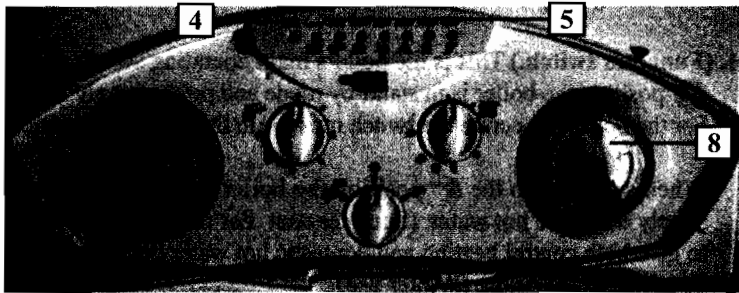

4. **(Boiler On)** The boiler 'Stand by' indicator (green) lights when power is supplied to PCB.

5. **(Water Temperature)** The temperature of the water leaving the boiler is given by the red light indicators situated alongside the burner 'Stand by' indicator light.

6. **(Fault Indicator)** The S24/S30 Compact control unit has an in-built fault diagnostic function. When a fault occurs the type of fault is indicated by appropriately 'flashing' the red light indicator. A listing of the display lights and meanings can be found in Section 13 (4) of the Installation and Servicing Instructions.

7. **(Boiler Lockout)** When the first red light indicator from right lights (flame or gas fault) the boiler will need to be put back into operation. To put the boiler back into operation, the function switch must be switched to  position and after a few seconds back to its previous (summer or winter) position.

If the second red light indicator from right lights (overheat fault) the boiler will need to be put back into operation. To put the boiler back into operation, the reset button on the overheat safety thermostat must be pressed into position and the function switch must be switched to  position and after a few seconds back to its previous (summer or winter) position.

8. **(Pressure gauge)** The pointer on the gauge indicates the pressure within the boiler and central heating system and should, when the water is cold, read between 1 and 2 bar.

If the pressure gauge falls below 1 bar the system and boiler must be re-pressurised. *(For re-pressurising the system refer section 12 of the Installation and Servicing Instructions.)*

Note. A Service Engineer must be contacted if boiler shutdown continues to occur

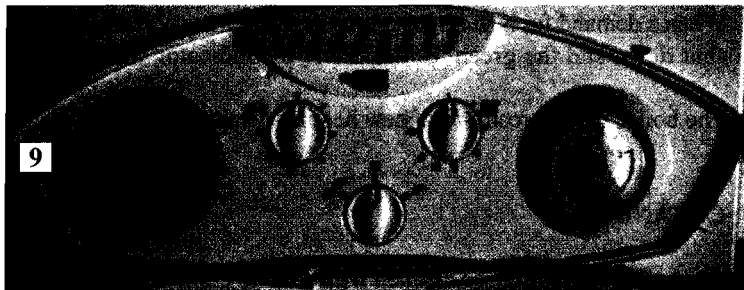

9. (Clock) A time clock to allow the automatic switching 'On' and 'Off' for central heating operating periods is available for the S24/S30 Compact as standard.

The operational time periods may be set as follows:

- ❑ Rotate the clock actuator mechanisms clockwise, by hand, until the arrow indicates the current time, see *figure 4*. In *figure 4*, current time is 21:05.
- ❑ The time is set in 24 hour format, e.g. the time for 1pm would be 13

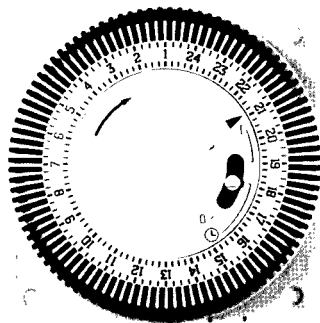

Fig 4

- ❑ Select the 'On' times by pushing the black tappets to the outside.
- ❑ Select the 'Off' times by pushing the black tappets towards the centre of the clock.

The clock shown in *figure 4* is set as follows:

The clock operation can be set by a selection switch. The switch has 3 positions:

1 (Up) position: The boiler is controlled by the function switch (Item 1 in *Figure 3*) independent from clock tappets.

⊕ (Mid) position: The boiler is controlled by both function switch and clock tappets.

0 (Down) position: The boiler is off independent from function switch.

FROST PROTECTION

The S24/S30 Compact has a built in frost protection device that protects the boiler from freezing. If the boiler is to be left and there is a risk of frost, ensure that the gas and electrical supplies are left connected. The frost protection device will light the boiler when the temperature of the boiler water falls below 6°C. When the temperature reaches 15°C, the boiler stops.

Note: This device works irrespective of any room thermostat setting and will protect the boiler.

SYSTEM PRESSURE.

On installation your installer will have filled the boiler and system to its effective working pressure. The boiler's pressure gauge should be regularly checked to ensure that this pressure is maintained between 1 and 2 bar. If there is a significant or frequent drop in pressure then your installer should be consulted.

OPERATING THE BOILER

Prior to operating the boiler check that the pointer on the boiler's pressure gauge is showing a pressure of between 1 and 2bar.

Set the boiler's 'Central Heating' and 'Domestic Hot Water' temperature controls to maximum by turning fully clockwise and set the external 'Room Thermostat' (if fitted) to maximum. (To set the room thermostat refer to its manufacturer's supplied user instructions.)

Switch the boiler's functional switch to the  position. The boiler's integral control unit will now automatically carry out pre-ignition safety checks before finally igniting the burner.

The 'Central Heating' and 'Domestic Hot Water' temperature controls and 'Room Thermostat' can now be set to the desired temperature settings.

When a demand for heat no longer exists, the burner will automatically shut down and the green 'Boiler Stand by' indicator will still light.

The boiler will be ready for a new heating demand.

CLEANING

The boiler casing may be cleaned with a damp cloth followed by a dry cloth to polish. **Do not use** abrasive or solvent cleaners.

FURTHER ADVICE

For further advice or information contact Heat Line™ Service Enquiries by telephone on **08706 092091** or e-mail at our web site www.heatline.co.uk